

INTERFACE AND SWITCHING APPLICATION.

FEATURES

- High density cell design for low $R_{DS(ON)}$.
- Voltage controlled small signal switch.
- Rugged and reliable.
- High saturation current capability.

MAXIMUM RATING (Ta=25 °C)

CHARACTERISTIC	SYMBOL	RATING	UNIT
Drain-Source Voltage	V_{DSS}	60	V
Gate-Source Voltage	V_{GSS}	±20	V
Drain Current	Continuous	I_D	300
	Pulsed (Note 1)	I_{DP}	1200
Drain Power Dissipation (Note 2)	P_D	300	mW
Junction Temperature	T_j	150	°C
Storage Temperature Range	T_{stg}	-55 ~ 150	°C

Note 1) Pulse Width $\leq 10 \mu s$, Duty Cycle $\leq 1\%$

Note 2) Package mounted on a glass epoxy PCB(100mm² × 1mm)

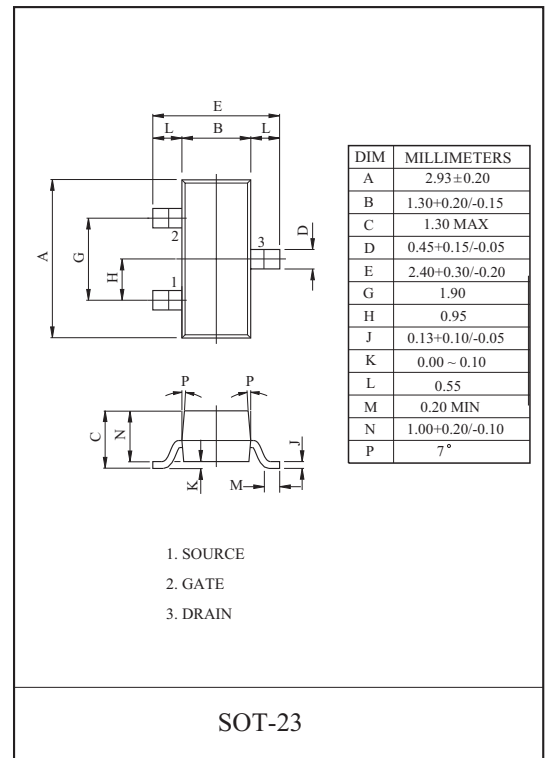

EQUIVALENT CIRCUIT

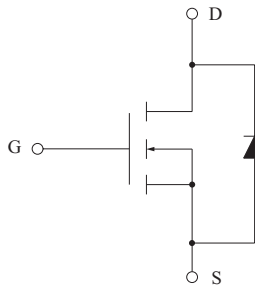

THIS TRANSISTOR IS ELECTROSTATIC SENSITIVE DEVICE.
PLEASE HANDLE WITH CAUTION.

Marking

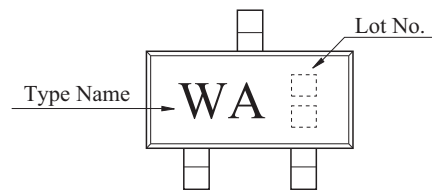

ELECTRICAL CHARACTERISTICS (Ta=25 °C)

CHARACTERISTIC	SYMBOL	TEST CONDITION	MIN.	TYP.	MAX.	UNIT
Drain-Source Breakdown Voltage	BV_{DSS}	$V_{GS}=0V, I_D=10 \mu A$	60	-	-	V
Zero Gate Voltage Drain Current	I_{DSS}	$V_{DS}=60V, V_{GS}=0V$	-	-	1	μA
Gate-Body Leakage, Forward	I_{GSSF}	$V_{GS}=20V, V_{DS}=0V$	-	-	100	nA
Gate-Body Leakage, Reverse	I_{GSSR}	$V_{GS}=-20V, V_{DS}=0V$	-	-	-100	nA

2N7002

ELECTRICAL CHARACTERISTICS (Ta=25 °C) ON CHARACTERISTICS (Note 3)

CHARACTERISTIC	SYMBOL	TEST CONDITION	MIN.	TYP.	MAX.	UNIT
Gate Threshold Voltage	V_{th}	$V_{DS}=V_{GS}, I_D=250\mu A$	1.1	1.8	2.3	V
Drain-Source ON Resistance	$R_{DS(ON)}$	$V_{GS}=10V, I_D=500mA$	-	1.2	1.8	Ω
		$V_{GS}=5V, I_D=50mA$	-	1.5	2.1	
Drain-Source ON Voltage	$V_{DS(ON)}$	$V_{GS}=10V, I_D=500mA$	-	0.6	0.9	V
		$V_{GS}=5V, I_D=50mA$	-	0.075	0.105	
On State Drain Current	$I_{D(ON)}$	$V_{GS}=10V, V_{DS} \geq 2 V_{DS(ON)}$	500	-	-	mA
Forward Transconductance	g_{FS}	$V_{DS}=10V, I_D=500mA$	200	580	-	mS
Drain-Source Diode Forward Voltage	V_{SD}	$V_{GS}=0V, I_S=200mA$ (Note1)	-	0.78	1.15	V

(Note 3) Pulse Test : Pulse Width $\leq 80\mu s$, Duty Cycle $\leq 1\%$

DYNAMIC CHARACTERISTICS

CHARACTERISTIC	SYMBOL	TEST CONDITION	MIN.	TYP.	MAX.	UNIT	
Input Capacitance	C_{iss}	$V_{DS}=25V, V_{GS}=0V, f=1MHz$	-	47.1	-	pF	
Reverse Transfer Capacitance	C_{rss}		-	3.5	-		
Output Capacitance	C_{oss}		-	8.8	-		
Switching Time	Turn-On Time	t_{on}	$V_{DD}=30V, R_L=155\Omega, I_D=190mA,$ $V_{GS}=10V$	-	8.8	-	nS
	Turn-Off Time	t_{off}		-	14.8	-	

SWITCHING TIME TEST CIRCUIT

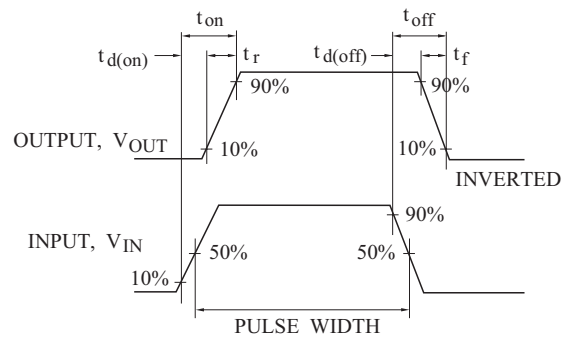
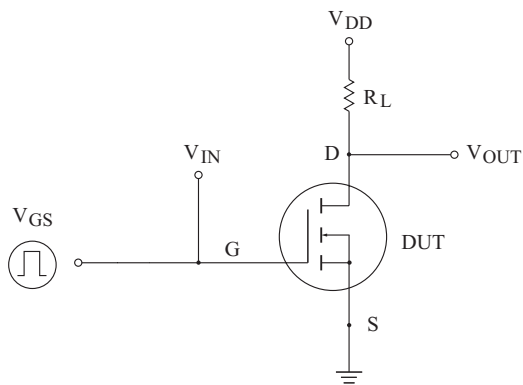

2N7002

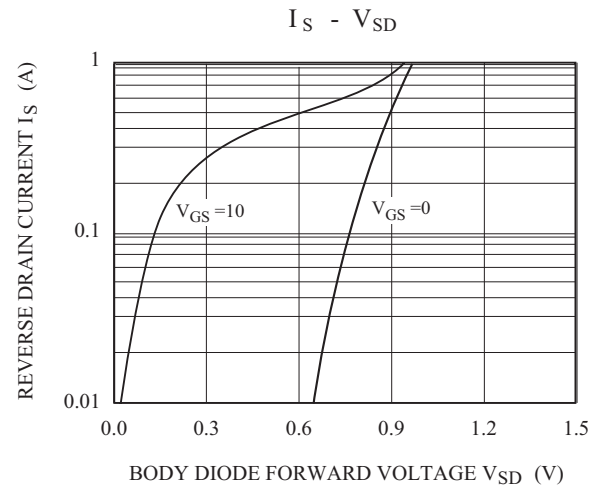
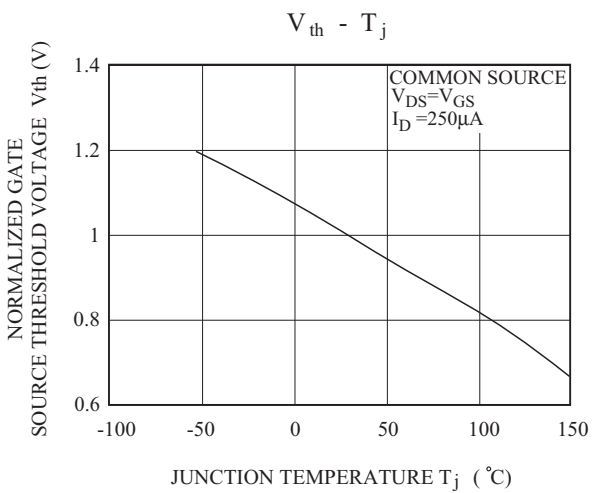
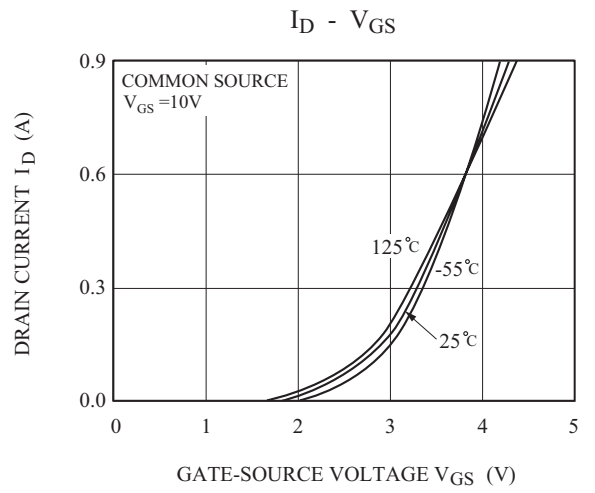
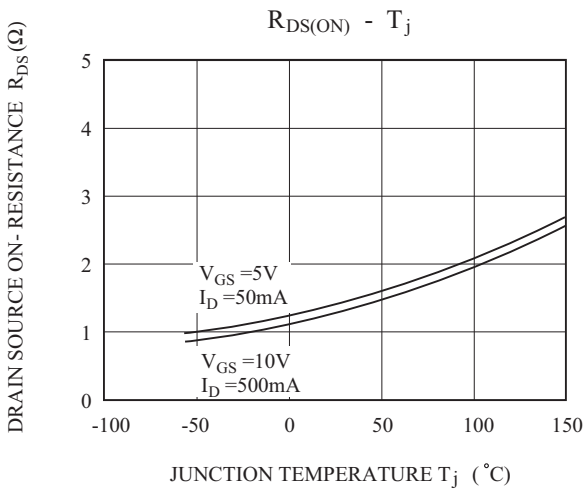
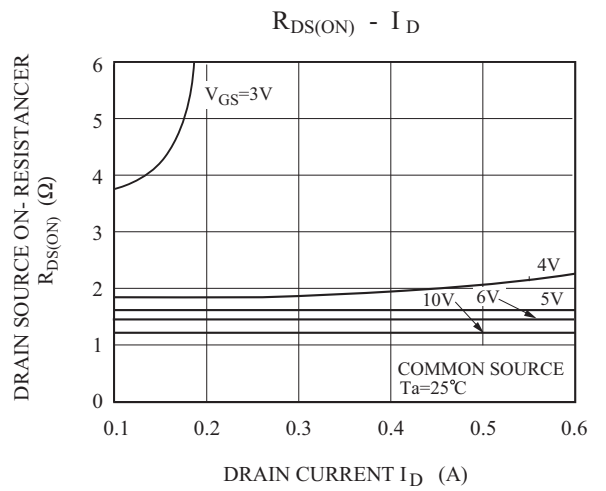
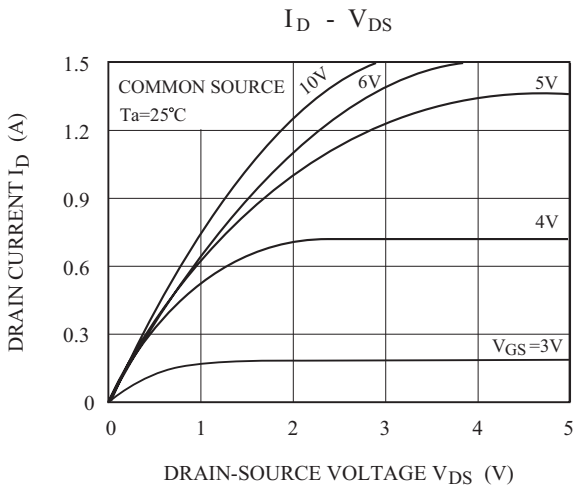

2N7002

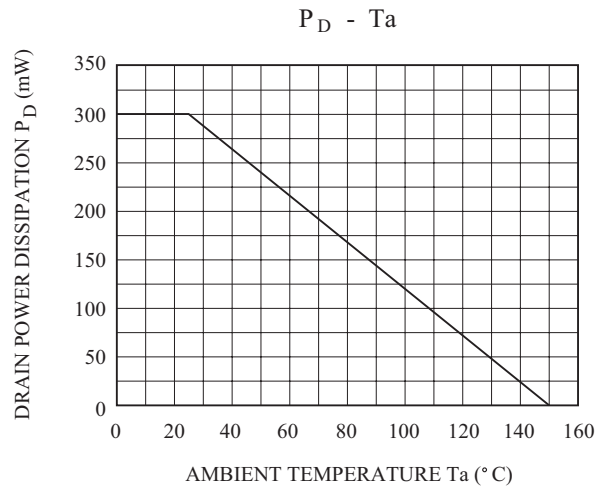
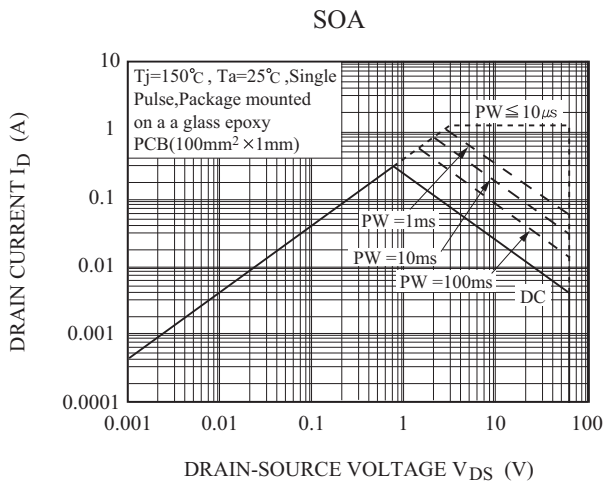
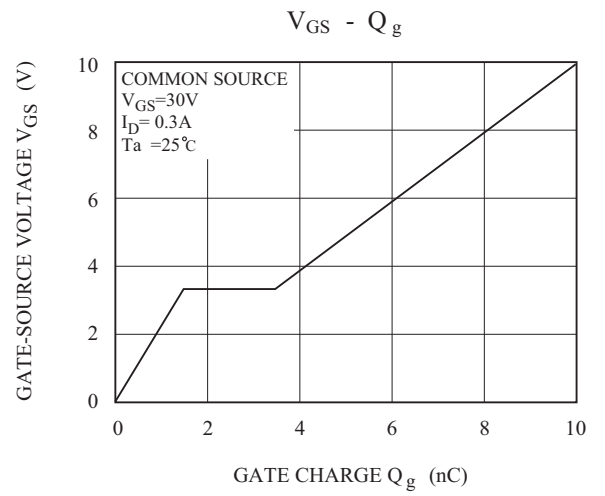
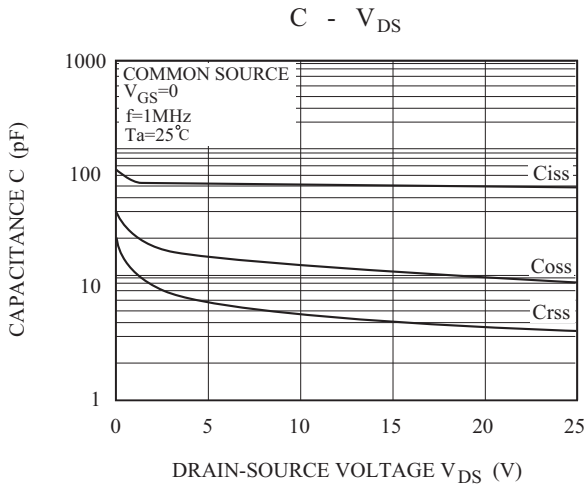

www.s-manuals.com