

4V Drive Nch MOS FET

2SK2504

●Structure

Silicon N-channel MOS FET

●Features

- 1) Low On-resistance.
- 2) Fast switching speed.
- 3) Wide SOA (safe operating area).
- 4) 4V drive.
- 5) Drive circuits can be simple.
- 6) Parallel use is easy.

●Applications

Switching

●Packaging specifications

| Type | Package | Taping |
|---------|------------------------------|--------|
| | Code | TL |
| | Basic ordering unit (pieces) | 2500 |
| 2SK2504 | | ○ |

●External dimensions (Unit : mm)

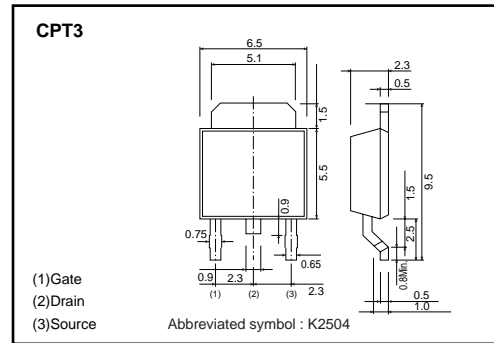

●Inner circuit

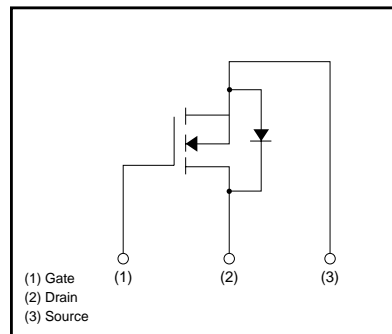

●Absolute maximum ratings (Ta=25°C)

| Parameter | Symbol | Limits | Unit | |
|--|------------------|--------------------|------|---|
| Drain-source voltage | V _{DSS} | 100 | V | |
| Gate-source voltage | V _{GSS} | ±20 | V | |
| Drain current | Continuous | I _D | 5 | A |
| | Pulsed | I _{DP} * | 20 | A |
| Reverse drain current | Continuous | I _{DR} | 5 | A |
| | Pulsed | I _{DRP} * | 20 | A |
| Total power dissipation (T _C =25°C) | P _D | 20 | W | |
| Channel temperature | T _{ch} | 150 | °C | |
| Storage temperature | T _{stg} | -55 to +150 | °C | |

* P_w ≤ 10μs, Duty cycle ≤ 1%

Transistors

●Electrical characteristics (Ta=25°C)

| Parameter | Symbol | Min. | Typ. | Max. | Unit | Test Conditions |
|---|----------------------|------|------|------|------|---|
| Gate-source leakage | I _{GSS} | – | – | ±100 | nA | V _{GS} = ±20V, V _{DS} =0V |
| Drain-source breakdown voltage | V _{(BR)DSS} | 100 | – | – | V | I _D =1mA, V _{GS} =0V |
| Zero gate voltage drain current | I _{DSS} | – | – | 10 | μA | V _{DS} =100V, V _{GS} =0V |
| Gate threshold voltage | V _{GS(th)} | 1.0 | – | 2.5 | V | V _{DS} =10V, I _D =1mA |
| Static drain-source on-state resistance | R _{DS(on)} | – | 0.18 | 0.22 | Ω | I _D =2.5A, V _{GS} =10V |
| | | – | 0.25 | 0.28 | | I _D =2.5A, V _{GS} =4V |
| Forward transfer admittance | Y _{fs} * | 4.0 | – | – | S | I _D =2.5A, V _{DS} =10V |
| Input capacitance | C _{iss} | – | 520 | – | pF | V _{DS} =10V |
| Output capacitance | C _{oss} | – | 175 | – | pF | V _{GS} =0V |
| Reverse transfer capacitance | C _{rss} | – | 60 | – | pF | f=1MHz |
| Turn-on delay time | t _{d(on)} | – | 5.0 | – | ns | I _D =2.5A, V _{DD} ≈50V |
| Rise time | t _r | – | 20 | – | ns | V _{GS} =10V |
| Turn-off delay time | t _{d(off)} | – | 50 | – | ns | R _L =20Ω |
| Fall time | t _f | – | 20 | – | ns | R _C =10Ω |

* P_w ≤ 300μs, Duty cycle ≤ 1%

Transistors

●Electrical characteristics curve

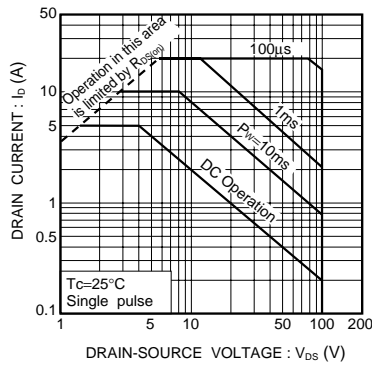

Fig.1 Maximum Safe Operating Area

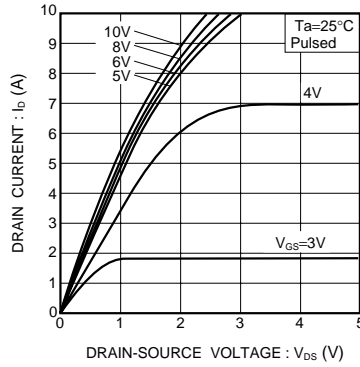

Fig.2 Typical Output Characteristics

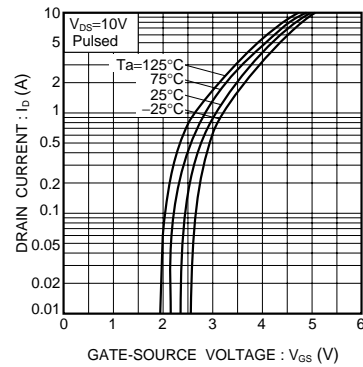

Fig.3 Typical Transfer Characteristics

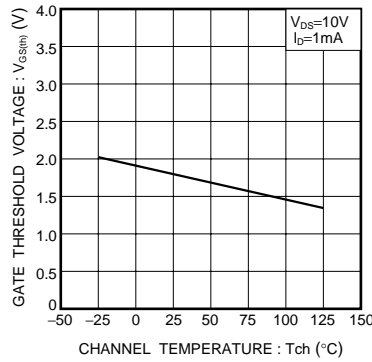

Fig.4 Gate Threshold Voltage vs. Channel Temperature

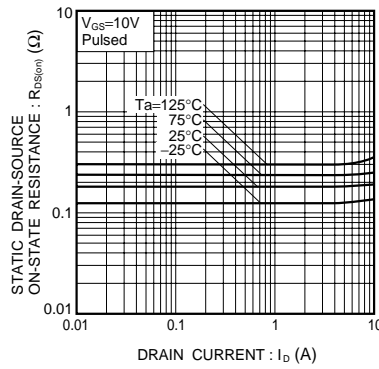

Fig.5 Static Drain-Source On-State Resistance vs. Drain Current (I)

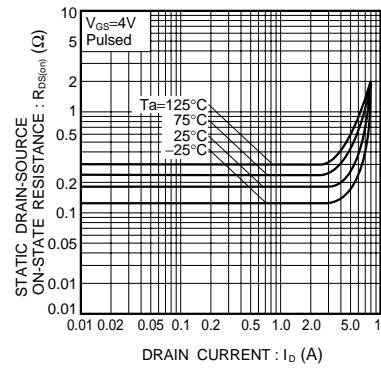

Fig.6 Static Drain-Source On-State Resistance vs. Drain Current (II)

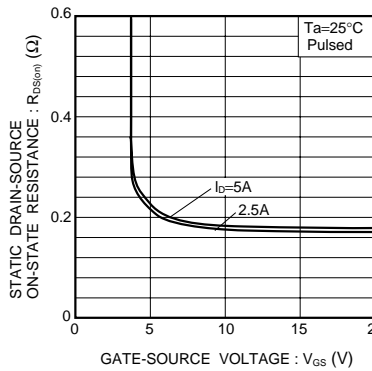

Fig.7 Static Drain-Source On-State Resistance vs. Gate-Source Voltage

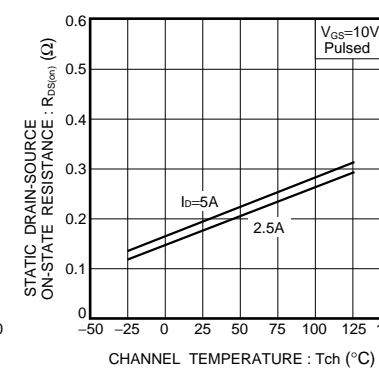

Fig.8 Static Drain-Source On-State Resistance vs. Channel Temperature

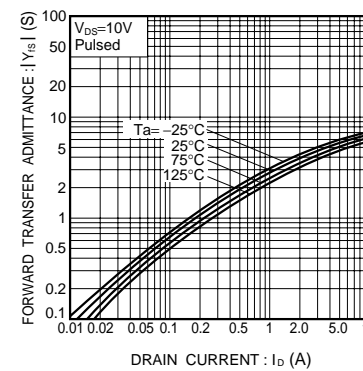

Fig.9 Forward Transfer Admittance vs. Drain Current

Transistors

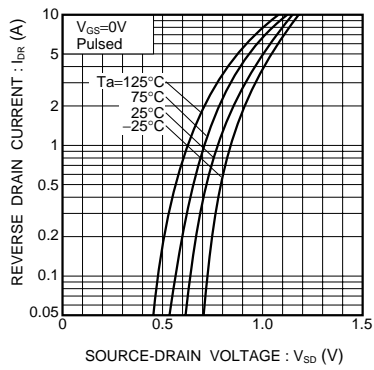

Fig.10 Reverse Drain Current vs. Source-Drain Voltage (I)

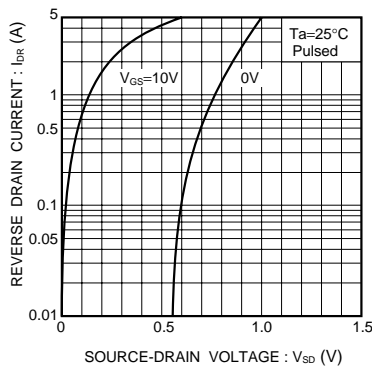

Fig.11 Reverse Drain Current vs. Source-Drain Voltage (II)

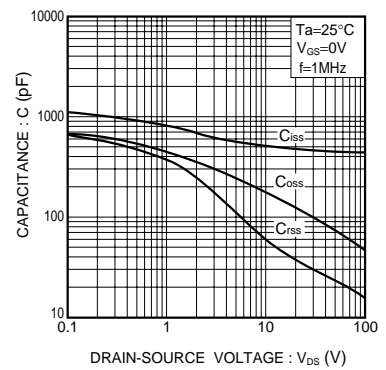

Fig.12 Typical Capacitance vs. Drain-Source Voltage

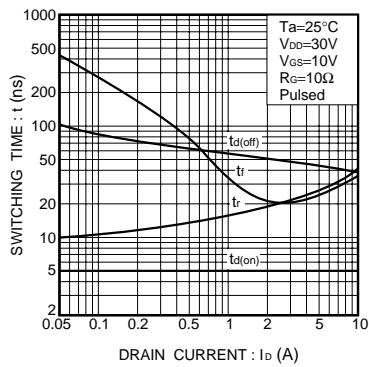

Fig.13 Switching characteristics (See Figures 16 and 17 for the measurement circuit and resultant waveforms)

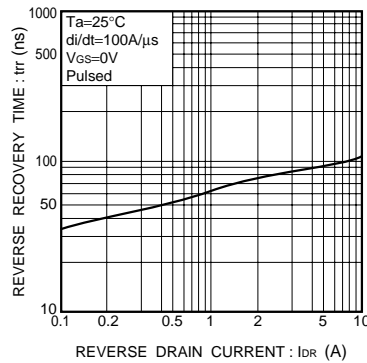

Fig.14 Reverse Recovery Time vs. Reverse Drain Current

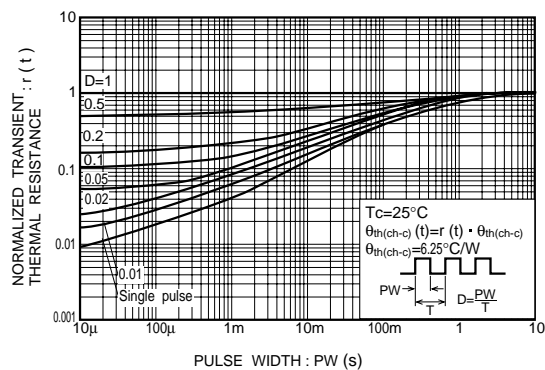

Fig.15 Normalized Transient Thermal Resistance vs. Pulse Width

Transistors

● Switching characteristics measurement circuit

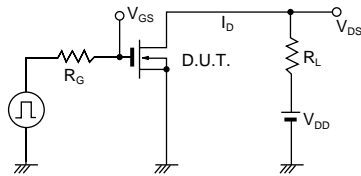

Fig.16 Switching Time Test Circuit

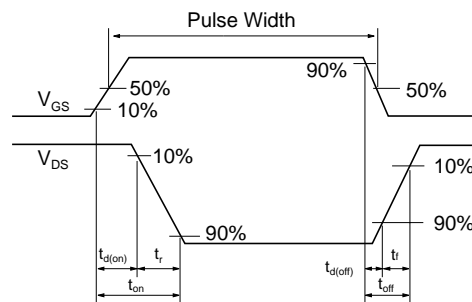

Fig.17 Switching Time Waveforms

Notes

- No technical content pages of this document may be reproduced in any form or transmitted by any means without prior permission of ROHM CO.,LTD.
- The contents described herein are subject to change without notice. The specifications for the product described in this document are for reference only. Upon actual use, therefore, please request that specifications to be separately delivered.
- Application circuit diagrams and circuit constants contained herein are shown as examples of standard use and operation. Please pay careful attention to the peripheral conditions when designing circuits and deciding upon circuit constants in the set.
- Any data, including, but not limited to application circuit diagrams information, described herein are intended only as illustrations of such devices and not as the specifications for such devices. ROHM CO.,LTD. disclaims any warranty that any use of such devices shall be free from infringement of any third party's intellectual property rights or other proprietary rights, and further, assumes no liability of whatsoever nature in the event of any such infringement, or arising from or connected with or related to the use of such devices.
- Upon the sale of any such devices, other than for buyer's right to use such devices itself, resell or otherwise dispose of the same, no express or implied right or license to practice or commercially exploit any intellectual property rights or other proprietary rights owned or controlled by
- ROHM CO., LTD. is granted to any such buyer.
- Products listed in this document are no antiradiation design.

The products listed in this document are designed to be used with ordinary electronic equipment or devices (such as audio visual equipment, office-automation equipment, communications devices, electrical appliances and electronic toys).

Should you intend to use these products with equipment or devices which require an extremely high level of reliability and the malfunction of which would directly endanger human life (such as medical instruments, transportation equipment, aerospace machinery, nuclear-reactor controllers, fuel controllers and other safety devices), please be sure to consult with our sales representative in advance.

About Export Control Order in Japan

Products described herein are the objects of controlled goods in Annex 1 (Item 16) of Export Trade Control Order in Japan.

In case of export from Japan, please confirm if it applies to "objective" criteria or an "informed" (by MITI clause) on the basis of "catch all controls for Non-Proliferation of Weapons of Mass Destruction.

www.s-manuals.com