

General Description

The AON7410 uses advanced trench technology and design to provide excellent $R_{DS(ON)}$ with low gate charge. This device is suitable for use in DC - DC converters and Load Switch applications.

RoHS and Halogen-Free Compliant

Features

V_{DS} (V) = 30V
 I_D = 24A ($V_{GS} = 10V$)
 $R_{DS(ON)} < 20m\Omega$ ($V_{GS} = 10V$)
 $R_{DS(ON)} < 26m\Omega$ ($V_{GS} = 4.5V$)

100% UIS Tested
 100% Rg Tested

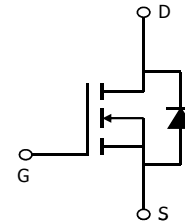
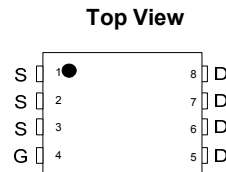
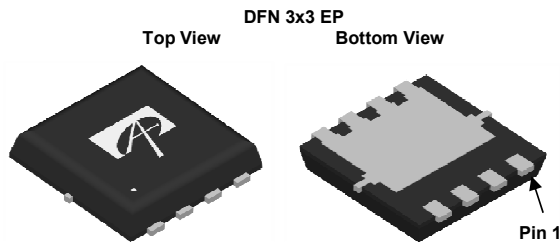

Orderable Part Number	Package Type	Form	Minimum Order Quantity
AON7410	DFN 3x3 EP	Tape & Reel	5000

Absolute Maximum Ratings $T_A=25^\circ\text{C}$ unless otherwise noted

Parameter	Symbol	Maximum	Units
Drain-Source Voltage	V_{DS}	30	V
Gate-Source Voltage	V_{GS}	± 20	V
Continuous Drain Current ^B	I_D	$T_C=25^\circ\text{C}$	A
		$T_C=100^\circ\text{C}$	
Pulsed Drain Current ^C	I_{DM}	50	A
Continuous Drain Current ^A	I_{DSM}	$T_A=25^\circ\text{C}$	A
		$T_A=70^\circ\text{C}$	
Avalanche Current ^C	I_{AS}, I_{AR}	17	A
Repetitive avalanche energy $L=0.1\text{mH}$ ^C	E_{AS}, E_{AR}	14	mJ
Power Dissipation ^B	P_D	$T_C=25^\circ\text{C}$	W
		$T_C=100^\circ\text{C}$	
Power Dissipation ^A	P_{DSM}	$T_A=25^\circ\text{C}$	W
		$T_A=70^\circ\text{C}$	
Junction and Storage Temperature Range	T_J, T_{STG}	-55 to 150	$^\circ\text{C}$

Thermal Characteristics

Parameter	Symbol	Typ	Max	Units
Maximum Junction-to-Ambient ^A	$R_{\theta JA}$	$t \leq 10\text{s}$	30	$^\circ\text{C/W}$
		Steady-State	60	$^\circ\text{C/W}$
Maximum Junction-to-Case ^B	$R_{\theta JC}$	5	6	$^\circ\text{C/W}$

Electrical Characteristics (T_J=25°C unless otherwise noted)

Symbol	Parameter	Conditions	Min	Typ	Max	Units
STATIC PARAMETERS						
BV _{DSS}	Drain-Source Breakdown Voltage	I _D =250μA, V _{GS} =0V	30			V
I _{DSS}	Zero Gate Voltage Drain Current	V _{DS} =30V, V _{GS} =0V T _J =55°C			1 5	μA
I _{GSS}	Gate-Body leakage current	V _{DS} =0V, V _{GS} = ±20V			±100	nA
V _{GS(th)}	Gate Threshold Voltage	V _{DS} =V _{GS} I _D =250μA	1.4	1.8	2.5	V
I _{D(ON)}	On state drain current	V _{GS} =10V, V _{DS} =5V	50			A
R _{DS(ON)}	Static Drain-Source On-Resistance	V _{GS} =10V, I _D =8A T _J =125°C		16 24	20 29	mΩ
		V _{GS} =4.5V, I _D =7A		21	26	
g _{FS}	Forward Transconductance	V _{DS} =5V, I _D =8A		30		S
V _{SD}	Diode Forward Voltage	I _S =1A, V _{GS} =0V		0.75	1	V
I _S	Maximum Body-Diode Continuous Current				20	A
DYNAMIC PARAMETERS						
C _{iss}	Input Capacitance	V _{GS} =0V, V _{DS} =15V, f=1MHz	440	550	660	pF
C _{oss}	Output Capacitance		77	110	143	pF
C _{rss}	Reverse Transfer Capacitance		33	55	77	pF
R _g	Gate resistance	V _{GS} =0V, V _{DS} =0V, f=1MHz	3	4	4.9	Ω
SWITCHING PARAMETERS						
Q _g (10V)	Total Gate Charge	V _{GS} =10V, V _{DS} =15V, I _D =8A	7.8	9.8	12	nC
Q _g (4.5V)	Total Gate Charge		3.6	4.6	5.5	nC
Q _{gs}	Gate Source Charge		1.4	1.8	2.2	nC
Q _{gd}	Gate Drain Charge		1.3	2.2	3	nC
t _{D(on)}	Turn-On DelayTime	V _{GS} =10V, V _{DS} =15V, R _L =2Ω, R _{GEN} =3Ω		5		ns
t _r	Turn-On Rise Time			3.2		ns
t _{D(off)}	Turn-Off DelayTime			24		ns
t _f	Turn-Off Fall Time			6		ns
t _{rr}	Body Diode Reverse Recovery Time	I _F =8A, di/dt=500A/μs	7	9	11	ns
Q _{rr}	Body Diode Reverse Recovery Charge	I _F =8A, di/dt=500A/μs	12	15	18	nC

- A: The value of R_{θJA} is measured with the device mounted on 1in² FR-4 board with 2oz. Copper, in a still air environment with T_A=25° C. The Power dissipation P_{DSM} is based on R_{θJA} t ≤ 10s value and the maximum allowed junction temperature of 150° C. The value in any given application depends on the user's specific board design, and the maximum temperature of 150° C may be used if the PCB allows it.
- B: The power dissipation P_D is based on T_{J(MAX)}=150° C, using junction-to-case thermal resistance, and is more useful in setting the upper dissipation limit for cases where additional heatsinking is used.
- C: Repetitive rating, pulse width limited by junction temperature T_{J(MAX)}=150° C.
- D: The R_{θJA} is the sum of the thermal impedance from junction to case R_{θJC} and case to ambient.
- E: The static characteristics in Figures 1 to 6 are obtained using <300ms pulses, duty cycle 0.5% max.
- F: These curves are based on the junction-to-case thermal impedance which is measured with the device mounted to a large heatsink, assuming a maximum junction temperature of T_{J(MAX)}=150° C.
- G: The maximum current rating is limited by bond-wires.
- H: These tests are performed with the device mounted on 1 in² FR-4 board with 2oz. Copper, in a still air environment with T_A=25° C. The SOA curve provides a single pulse rating.
- Rev12: Jul-2011

COMPONENTS IN LIFE SUPPORT DEVICES OR SYSTEMS ARE NOT AUTHORIZED. AOS DOES NOT ASSUME ANY LIABILITY ARISING OUT OF SUCH APPLICATIONS OR USES OF ITS PRODUCTS. AOS RESERVES THE RIGHT TO IMPROVE PRODUCT DESIGN, FUNCTIONS AND RELIABILITY WITHOUT NOTICE.

TYPICAL ELECTRICAL AND THERMAL CHARACTERISTICS

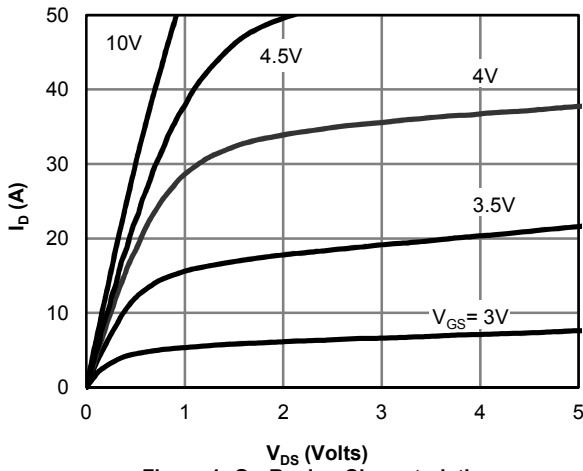

Figure 1: On-Region Characteristics

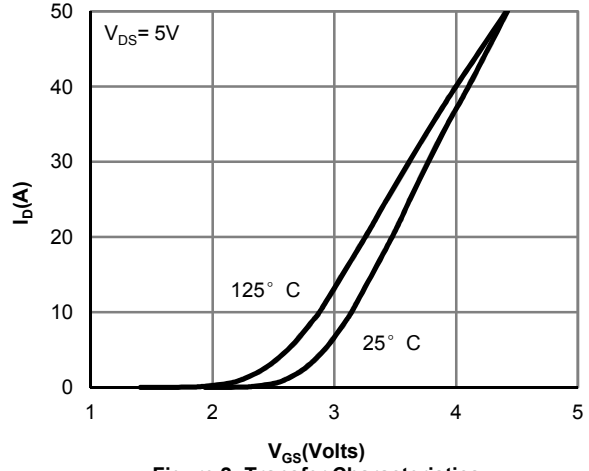

Figure 2: Transfer Characteristics

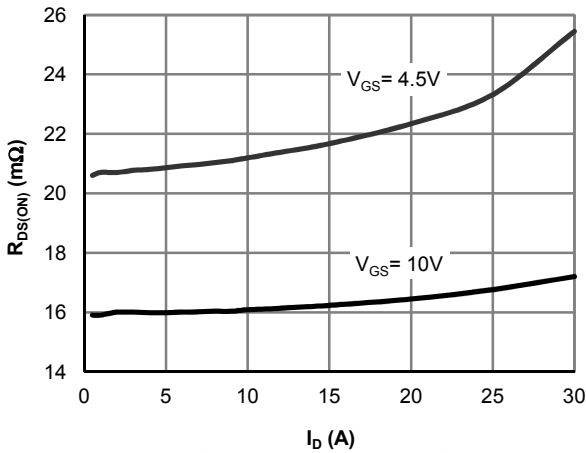

Figure 3: On-Resistance vs. Drain Current and Gate Voltage

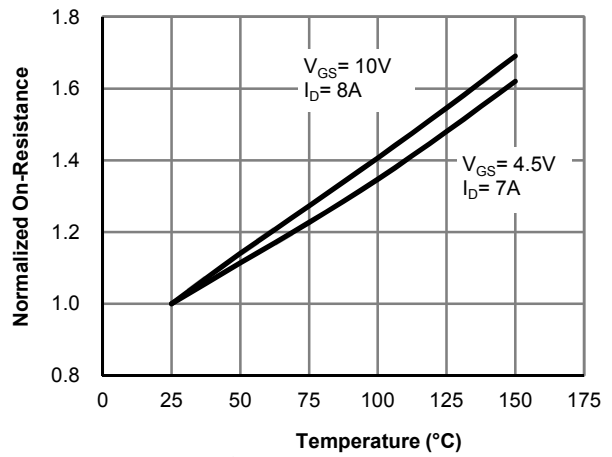

Figure 4: On-Resistance vs. Junction Temperature

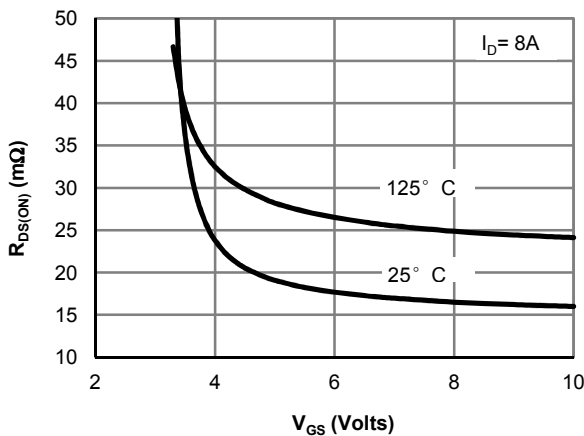

Figure 5: On-Resistance vs. Gate-Source Voltage

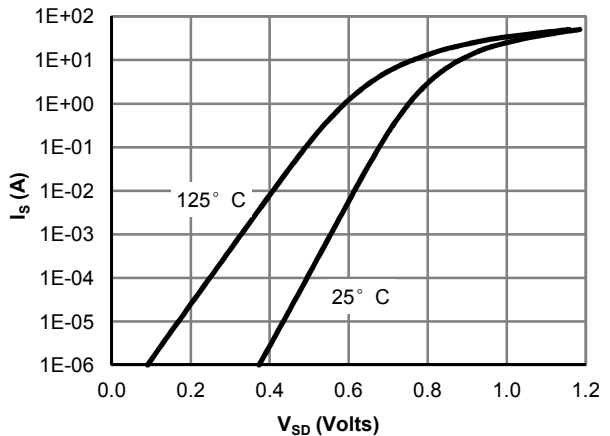

Figure 6: Body-Diode Characteristics

TYPICAL ELECTRICAL AND THERMAL CHARACTER

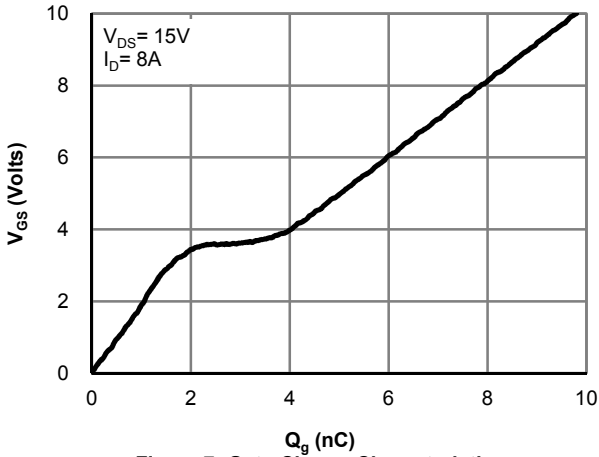

Figure 7: Gate-Charge Characteristics

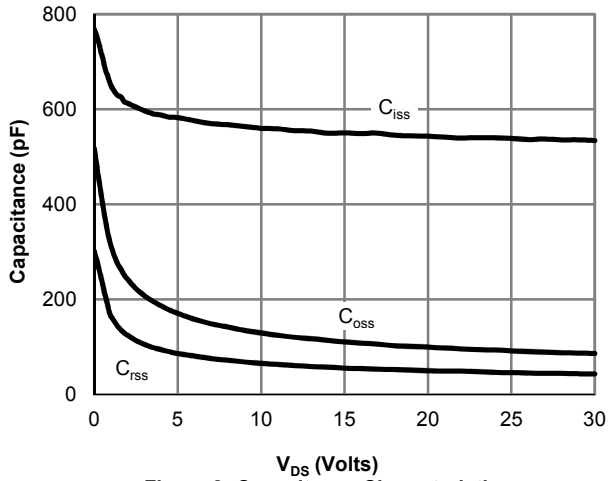

Figure 8: Capacitance Characteristics

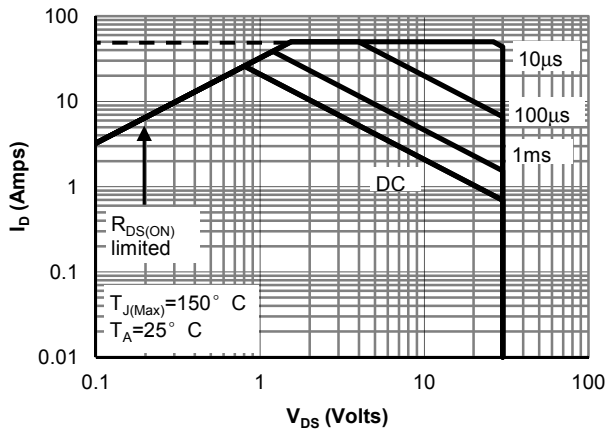

Figure 9: Maximum Forward Biased Safe Operating Area (Note H)

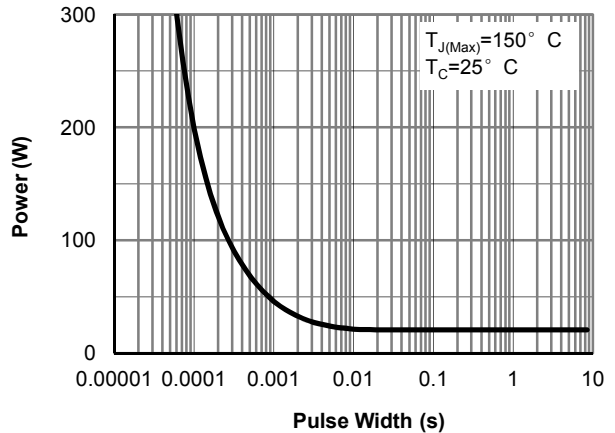

Figure 10: Single Pulse Power Rating Junction-to-Case (Note F)

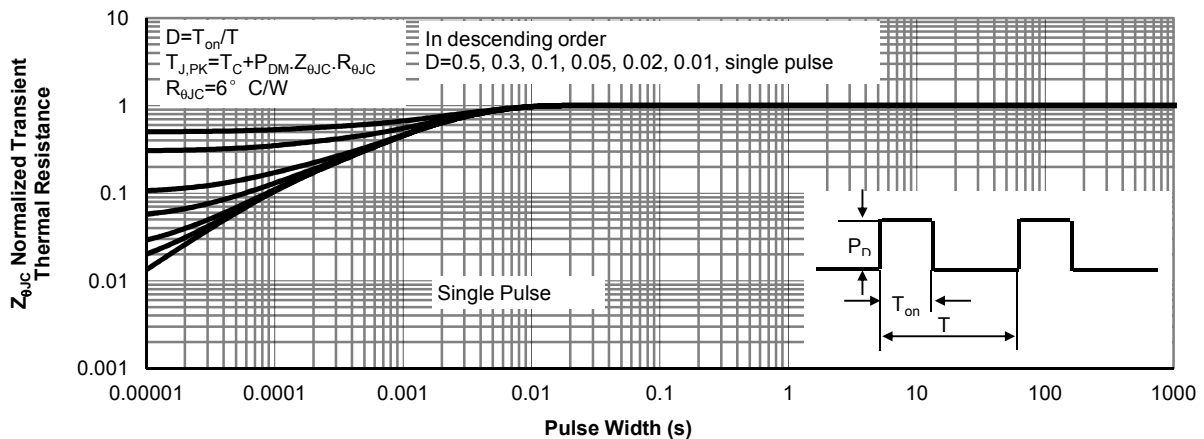

Figure 11: Normalized Maximum Transient Thermal Impedance (Note F)

TYPICAL ELECTRICAL AND THERMAL CHARACTERISTICS

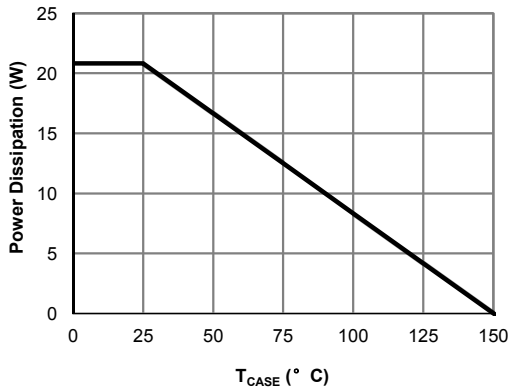

Figure 12: Power De-rating (Note F)

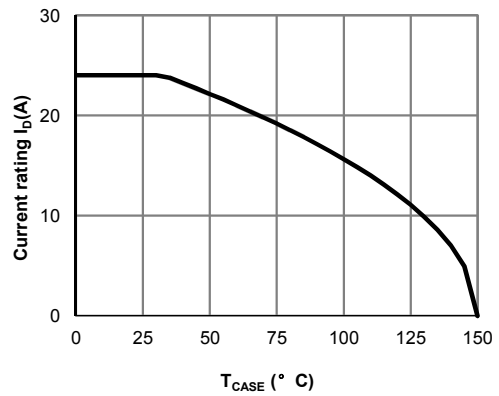

Figure 13: Current De-rating (Note F)

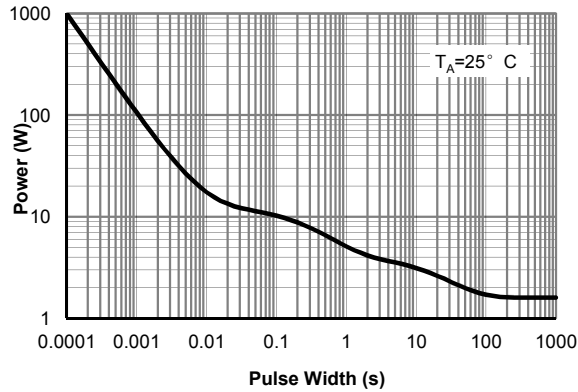

Figure 14: Single Pulse Power Rating Junction-to-Ambient (Note H)

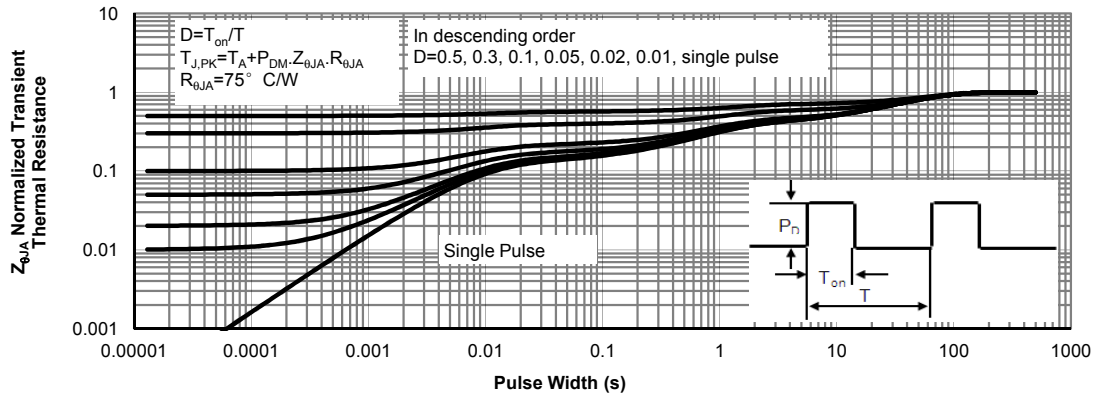
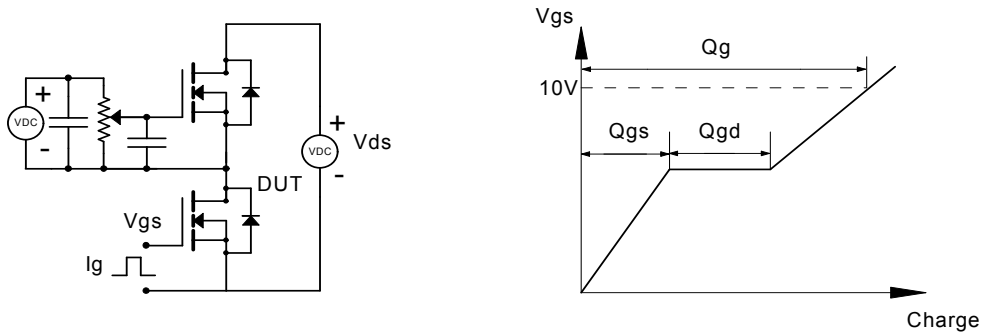
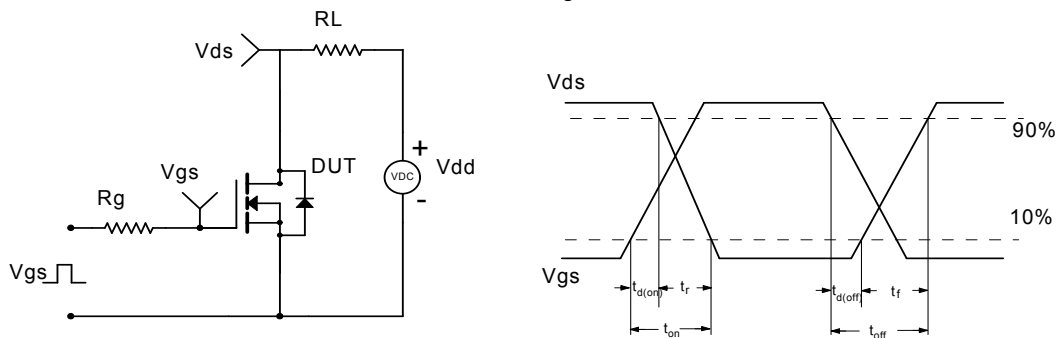

Figure 15: Normalized Maximum Transient Thermal Impedance(Note H)

Gate Charge Test Circuit & Waveform



Resistive Switching Test Circuit & Waveforms



Unclamped Inductive Switching (UIS) Test Circuit & Waveforms

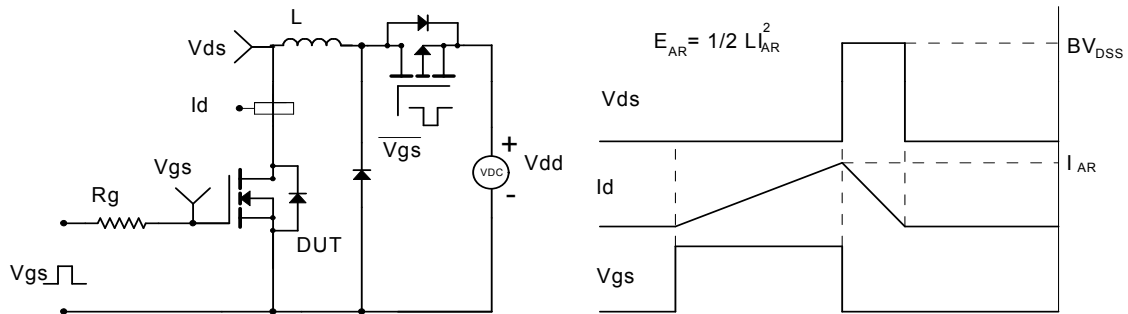

Diode Recovery Test Circuit & Waveforms

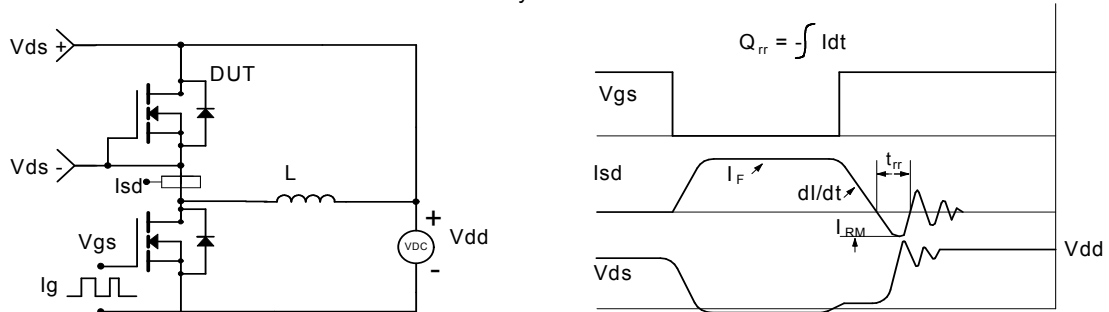



Document No.	PD-00853
Version	B
Title	AON7410 Marking Description

DFN3X3 PACKAGE MARKING DESCRIPTION

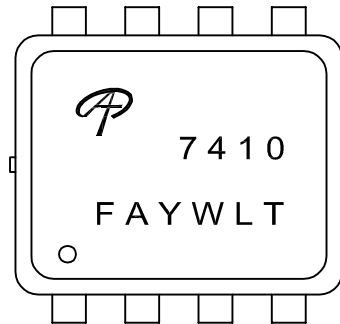

Green product

NOTE:	
LOGO	- AOS Logo
7410	- Part number code
F	- Fab code
A	- Assembly location code
Y	- Year code
W	- Week code
L&T	- Assembly lot code

PART NO.	DESCRIPTION	CODE
AON7410	Green product	7410
AON7410L	Green product	7410

www.s-manuals.com