

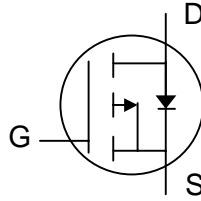

P-channel Enhancement-mode Power MOSFET

- Simple Drive Requirement**
- Low On-resistance**
- Surface Mount Device**
- RoHS-compliant, halogen-free**



BV_{DSS}	-16V
$R_{DS(ON)}$	60mΩ
I_D	-4A

Description

Advanced Power MOSFETs from APEC provide the designer with the best combination of fast switching, low on-resistance and cost-effectiveness.

The AP2307GN-HF-3 is in the popular SOT-23 small surface-mount package which is widely used in commercial and industrial applications where a small board footprint is required.

This device is well suited for use in medium current applications such as load switches and DC-DC converters.

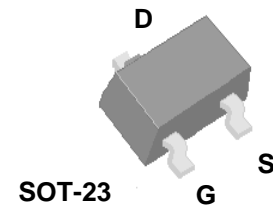

Absolute Maximum Ratings

Symbol	Parameter	Rating	Units
V_{DS}	Drain-Source Voltage	-16	V
V_{GS}	Gate-Source Voltage	±8	V
I_D at $T_A=25^{\circ}C$	Continuous Drain Current ³	-4	A
I_D at $T_A=70^{\circ}C$	Continuous Drain Current ³	-3.3	A
I_{DM}	Pulsed Drain Current ¹	-12	A
P_D at $T_A=25^{\circ}C$	Total Power Dissipation	1.38	W
T_{STG}	Storage Temperature Range	-55 to 150	°C
T_J	Operating Junction Temperature Range	-55 to 150	°C

Thermal Data

Symbol	Parameter	Value	Unit
Rthj-a	Maximum Thermal Resistance, Junction-ambient	90	°C/W

Ordering Information

AP2307GN-HF-3TR : RoHS-compliant halogen-free SOT-23, shipped on tape and reel, 3000pcs/reel



Electrical Specifications at $T_j=25^\circ\text{C}$ (unless otherwise specified)

Symbol	Parameter	Test Conditions	Min.	Typ.	Max.	Units
BV_{DSS}	Drain-Source Breakdown Voltage	$V_{GS}=0V, I_D=-250\mu A$	-16	-	-	V
$R_{DS(ON)}$	Static Drain-Source On-Resistance ²	$V_{GS}=-4.5V, I_D=-4A$	-	-	60	$m\Omega$
		$V_{GS}=-2.5V, I_D=-3.0A$	-	-	70	$m\Omega$
		$V_{GS}=-1.8V, I_D=-2.0A$	-	-	90	$m\Omega$
$V_{GS(th)}$	Gate Threshold Voltage	$V_{DS}=V_{GS}, I_D=-250\mu A$	-	-	-1.0	V
g_{fs}	Forward Transconductance	$V_{DS}=-5V, I_D=-4A$	-	12	-	S
I_{DSS}	Drain-Source Leakage Current	$V_{DS}=-16V, V_{GS}=0V$	-	-	-1	μA
	Drain-Source Leakage Current ($T_j=70^\circ\text{C}$)	$V_{DS}=-12V, V_{GS}=0V$	-	-	-25	μA
I_{GSS}	Gate-Source Leakage	$V_{GS}=\pm 8V, V_{DS}=0V$	-	-	± 100	nA
Q_g	Total Gate Charge ²	$I_D=-4A$	-	15	24	nC
Q_{gs}	Gate-Source Charge	$V_{DS}=-12V$	-	1.3	-	nC
Q_{gd}	Gate-Drain ("Miller") Charge	$V_{GS}=-4.5V$	-	4	-	nC
$t_{d(on)}$	Turn-on Delay Time ²	$V_{DS}=-10V$	-	8	-	ns
t_r	Rise Time	$I_D=-1A$	-	11	-	ns
$t_{d(off)}$	Turn-off Delay Time	$R_G=3.3\Omega, V_{GS}=-10V$	-	54	-	ns
t_f	Fall Time	$R_D=10\Omega$	-	36	-	ns
C_{iss}	Input Capacitance	$V_{GS}=0V$	-	985	1580	pF
C_{oss}	Output Capacitance	$V_{DS}=-15V$	-	180	-	pF
C_{rss}	Reverse Transfer Capacitance	$f=1.0\text{MHz}$	-	160	-	pF

Source-Drain Diode

Symbol	Parameter	Test Conditions	Min.	Typ.	Max.	Units
V_{SD}	Forward On Voltage ²	$I_S=-1.2A, V_{GS}=0V$	-	-	-1.2	V
t_{rr}	Reverse Recovery Time ²	$I_S=-4A, V_{GS}=0V,$	-	39	-	ns
Q_{rr}	Reverse Recovery Charge	$dI/dt=100A/\mu s$	-	26	-	nC

Notes:

1. Pulse width limited by maximum junction temperature.
2. Pulse test - pulse width $\leq 300\mu s$, duty cycle $\leq 2\%$
3. Surface mounted on 1in^2 copper pad of FR4 board, $t \leq 10\text{sec}$; 270°C/W when mounted on minimum copper pad.

THIS PRODUCT IS SENSITIVE TO ELECTROSTATIC DISCHARGE, PLEASE HANDLE WITH CAUTION.

USE OF THIS PRODUCT AS A CRITICAL COMPONENT IN LIFE SUPPORT OR OTHER SIMILAR SYSTEMS IS NOT AUTHORIZED.

APEC DOES NOT ASSUME ANY LIABILITY ARISING OUT OF THE APPLICATION OR USE OF ANY PRODUCT OR CIRCUIT DESCRIBED HEREIN; NEITHER DOES IT CONVEY ANY LICENSE UNDER ITS PATENT RIGHTS, NOR THE RIGHTS OF OTHERS.

APEC RESERVES THE RIGHT TO MAKE CHANGES WITHOUT FURTHER NOTICE TO ANY PRODUCTS HEREIN TO IMPROVE RELIABILITY, FUNCTION OR DESIGN.



Typical Electrical Characteristics

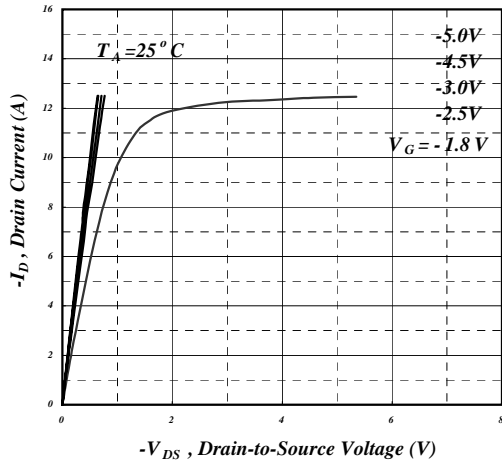

Fig 1. Typical Output Characteristics

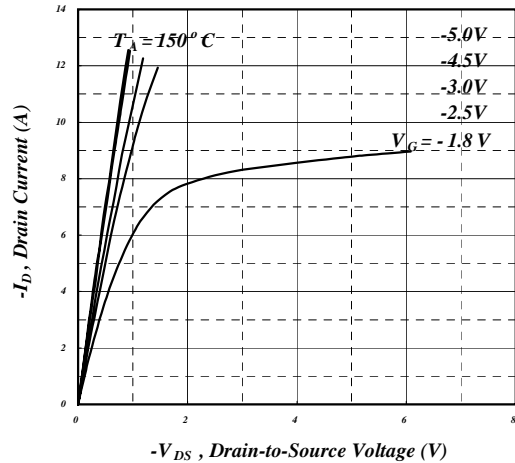

Fig 2. Typical Output Characteristics

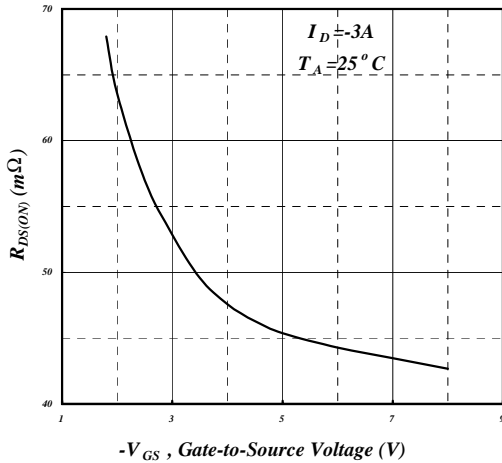

Fig 3. On-Resistance vs. Gate Voltage

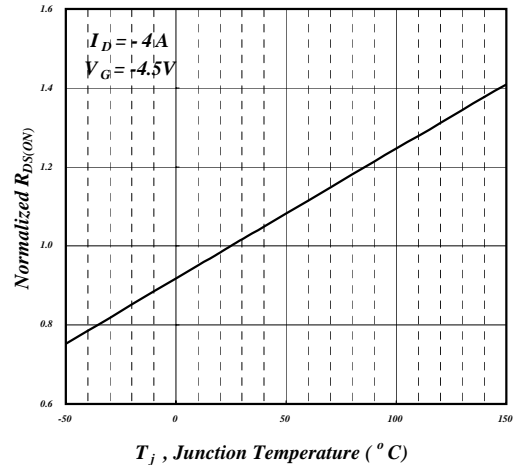

Fig 4. Normalized On-Resistance vs. Junction Temperature

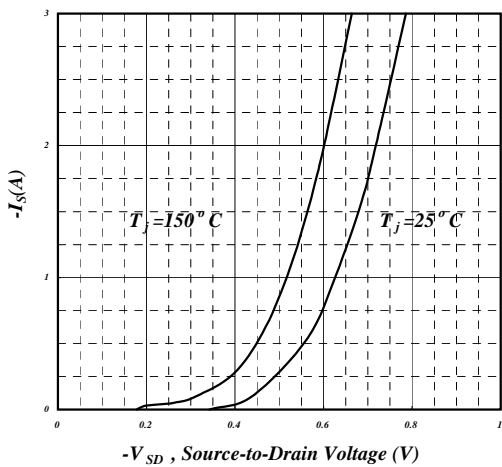

Fig 5. Forward Characteristic of Reverse Diode

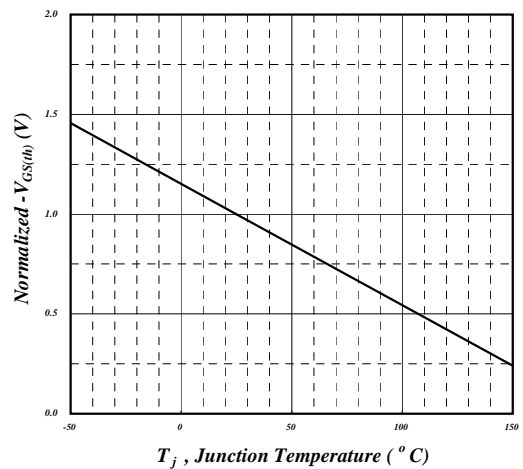

Fig 6. Gate Threshold Voltage vs. Junction Temperature



Typical Electrical Characteristics (cont.)

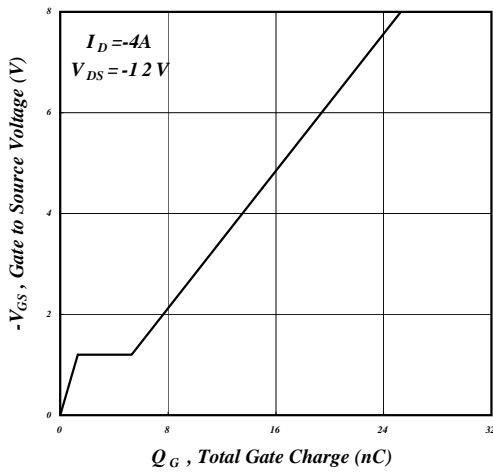

Fig 7. Gate Charge Characteristics

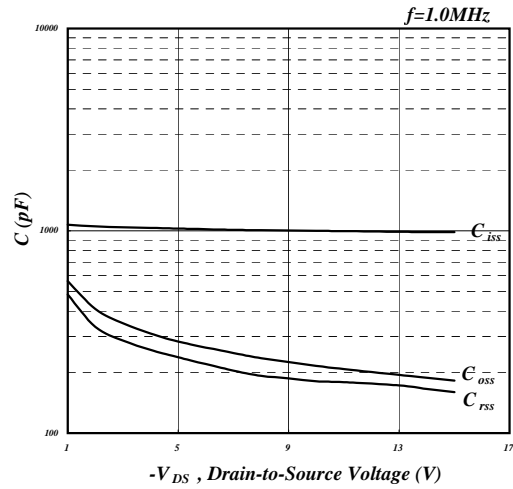

Fig 8. Typical Capacitance Characteristics

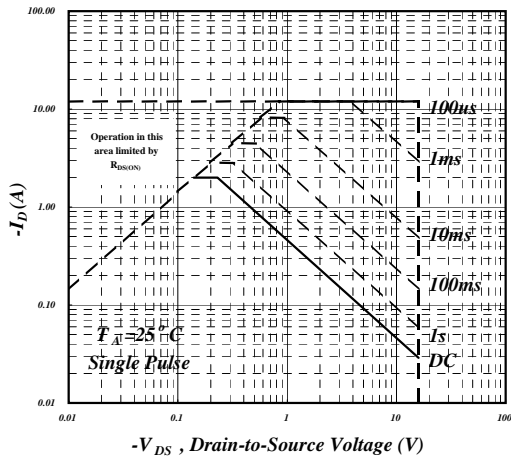

Fig 9. Maximum Safe Operating Area

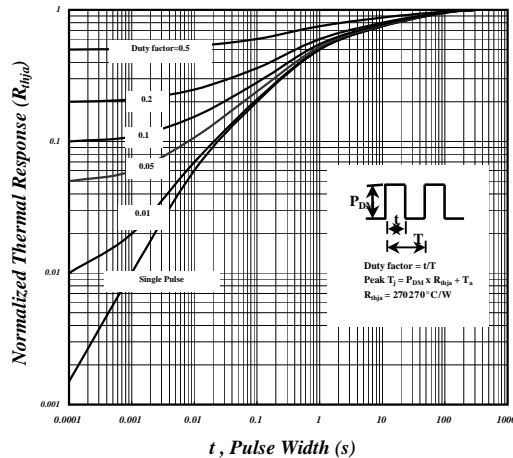

Fig 10. Effective Transient Thermal Impedance

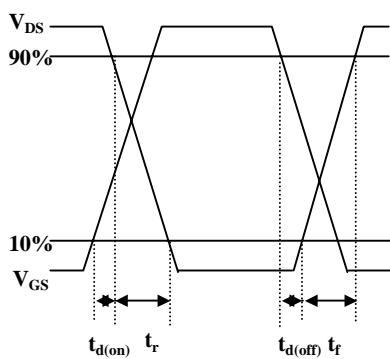

Fig 11. Switching Time Waveform

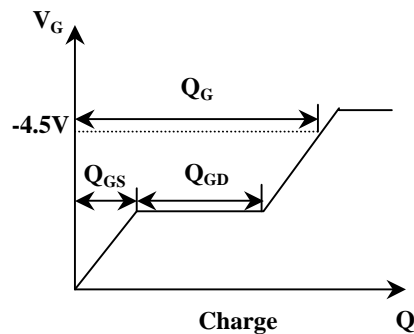
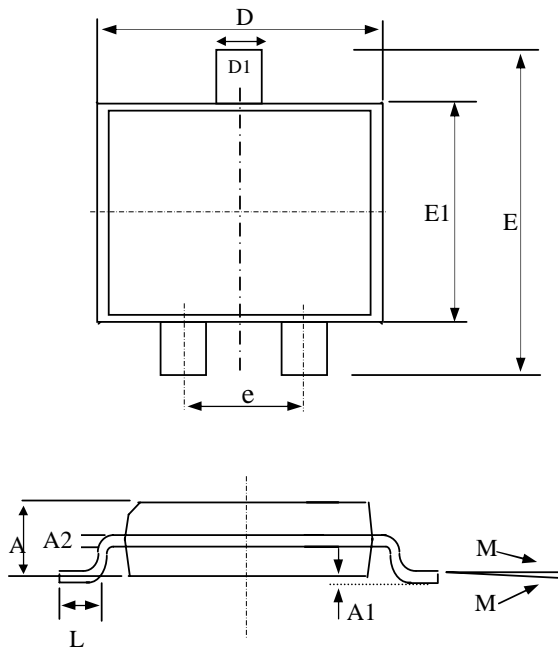

Fig 12. Gate Charge Waveform



Package Dimensions: SOT-23



SYMBOLS	Millimeters		
	MIN	NOM	MAX
A	0.88	--	1.30
A1	0.00	--	0.10
A2	0.08	--	0.25
D1	0.30	0.40	0.50
e	1.70	2.00	2.30
D	2.70	2.90	3.10
E	2.20	2.60	3.00
E1	1.20	1.50	1.80
M	0°	--	10°
L	0.30	--	0.60

1. All dimensions are in millimeters.
2. Dimensions do not include mold protrusions.

Marking Information:

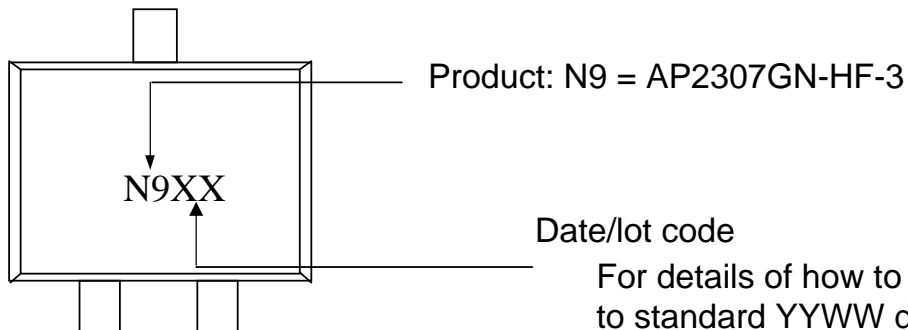

For details of how to convert this to standard YYWW date code format, please contact us directly.

www.s-manuals.com