

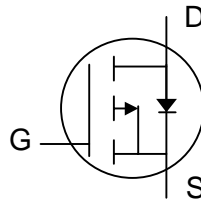

**P-channel Enhancement-mode Power MOSFET**

- Simple Drive Requirement**
- Low Gate Charge**
- Small Footprint, Low Profile**
- RoHS-compliant, halogen-free**



$BV_{DS}$	-20V
$R_{DS(ON)}$	52mΩ
$I_D$	-5A

**Description**

Advanced Power MOSFETs from APEC provide the designer with the best combination of fast switching, low on-resistance and cost-effectiveness.

The SOT-26 package is widely used for commercial and industrial applications, where space is at a premium.

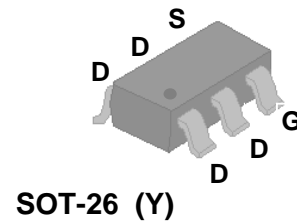

**Absolute Maximum Ratings**

Symbol	Parameter	Rating	Units
$V_{DS}$	Drain-Source Voltage	-20	V
$V_{GS}$	Gate-Source Voltage	±8	V
$I_D$ at $T_A=25^\circ\text{C}$	Continuous Drain Current <sup>3</sup>	-5	A
$I_D$ at $T_A=70^\circ\text{C}$	Continuous Drain Current <sup>3</sup>	-4	A
$I_{DM}$	Pulsed Drain Current <sup>1</sup>	-20	A
$P_D$ at $T_A=25^\circ\text{C}$	Total Power Dissipation	2	W
	Linear Derating Factor	0.016	W/°C
$T_{STG}$	Storage Temperature Range	-55 to 150	°C
$T_J$	Operating Junction Temperature Range	-55 to 150	°C

**Thermal Data**

Symbol	Parameter	Value	Unit
Rthj-a	Maximum Thermal Resistance, Junction-ambient	62.5	°C/W

**Ordering Information**

**AP2607GY-HF-3TR** : in RoHS-compliant halogen-free SOT-26 shipped on tape and reel (3000pcs/reel)



**Electrical Specifications at  $T_j=25^\circ\text{C}$  (unless otherwise specified)**

Symbol	Parameter	Test Conditions	Min.	Typ.	Max.	Units
$BV_{DSS}$	Drain-Source Breakdown Voltage	$V_{GS}=0V, I_D=-250\mu A$	-20	-	-	V
$R_{DS(ON)}$	Static Drain-Source On-Resistance <sup>2</sup>	$V_{GS}=-4.5V, I_D=-5A$	-	-	52	m $\Omega$
		$V_{GS}=-2.5V, I_D=-4A$	-	-	65	m $\Omega$
		$V_{GS}=-1.8V, I_D=-1A$	-	-	90	m $\Omega$
$V_{GS(th)}$	Gate Threshold Voltage	$V_{DS}=V_{GS}, I_D=-250\mu A$	-0.3	-	-1	V
$g_{fs}$	Forward Transconductance	$V_{DS}=-5V, I_D=-5A$	-	9	-	S
$I_{DSS}$	Drain-Source Leakage Current	$V_{DS}=-16V, V_{GS}=0V$	-	-	-1	$\mu A$
	Drain-Source Leakage Current ( $T_j=55^\circ\text{C}$ )	$V_{DS}=-16V, V_{GS}=0V$	-	-	-10	$\mu A$
$I_{GSS}$	Gate-Source Leakage	$V_{GS}= \pm 8V$	-	-	$\pm 100$	nA
$Q_g$	Total Gate Charge <sup>2</sup>	$I_D=-5A$	-	13	21	nC
$Q_{gs}$	Gate-Source Charge	$V_{DS}=-10V$	-	2.1	-	nC
$Q_{gd}$	Gate-Drain ("Miller") Charge	$V_{GS}=-4.5V$	-	5	-	nC
$t_{d(on)}$	Turn-on Delay Time <sup>2</sup>	$V_{DS}=-10V$	-	10	-	ns
$t_r$	Rise Time	$I_D=-1A$	-	18	-	ns
$t_{d(off)}$	Turn-off Delay Time	$R_G=3.3\Omega, V_{GS}=-5V$	-	23	-	ns
$t_f$	Fall Time	$R_D=10\Omega$	-	31	-	ns
$C_{iss}$	Input Capacitance	$V_{GS}=0V$	-	1030	1650	pF
$C_{oss}$	Output Capacitance	$V_{DS}=-20V$	-	120	-	pF
$C_{rss}$	Reverse Transfer Capacitance	$f=1.0\text{MHz}$	-	105	-	pF

**Source-Drain Diode**

Symbol	Parameter	Test Conditions	Min.	Typ.	Max.	Units
$V_{SD}$	Forward On Voltage <sup>2</sup>	$I_S=-1.2A, V_{GS}=0V$	-	-	-1.2	V
$t_{rr}$	Reverse Recovery Time <sup>2</sup>	$I_S=-5A, V_{GS}=0V$	-	29	-	ns
$Q_{rr}$	Reverse Recovery Charge	$di/dt=100A/\mu s$	-	20	-	nC

**Notes:**

1. Pulse width limited maximum junction temperature.
2. Pulse test - pulse width  $\leq 300\mu s$ , duty cycle  $\leq 2\%$
3. Surface mounted on 1 in<sup>2</sup> copper pad of FR4 board,  $t \leq 10\text{sec}$ ; 156 °C/W when mounted on minimum copper pad.

THIS PRODUCT IS SENSITIVE TO ELECTROSTATIC DISCHARGE, PLEASE HANDLE WITH CAUTION.

USE OF THIS PRODUCT AS A CRITICAL COMPONENT IN LIFE SUPPORT OR OTHER SIMILAR SYSTEMS IS NOT AUTHORIZED.

APEC DOES NOT ASSUME ANY LIABILITY ARISING OUT OF THE APPLICATION OR USE OF ANY PRODUCT OR CIRCUIT DESCRIBED HEREIN; NEITHER DOES IT CONVEY ANY LICENSE UNDER ITS PATENT RIGHTS, NOR THE RIGHTS OF OTHERS.

APEC RESERVES THE RIGHT TO MAKE CHANGES WITHOUT FURTHER NOTICE TO ANY PRODUCTS HEREIN TO IMPROVE RELIABILITY, FUNCTION OR DESIGN.



Typical Electrical Characteristics

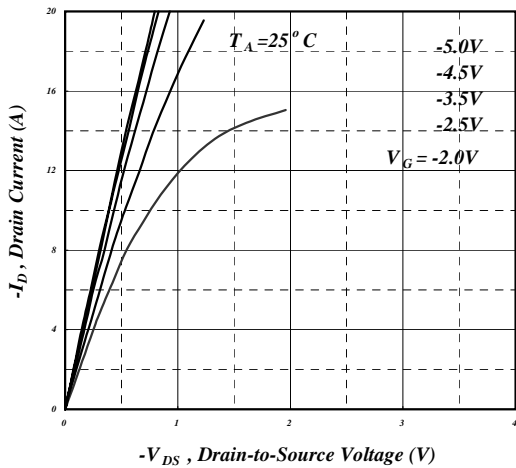

Fig 1. Typical Output Characteristics

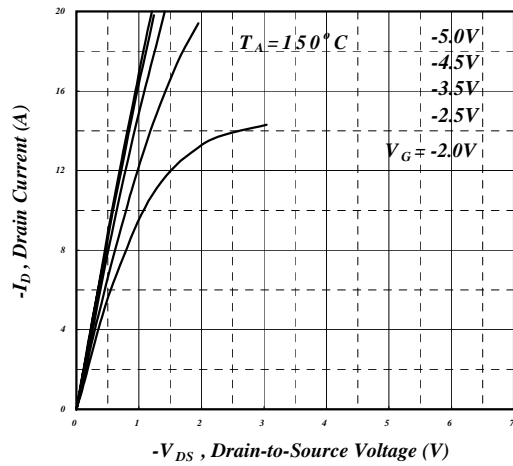

Fig 2. Typical Output Characteristics

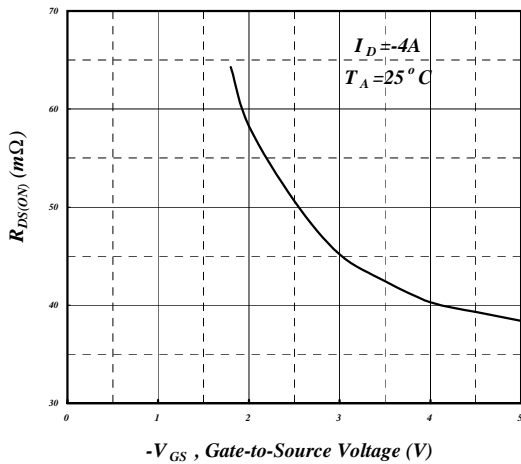

Fig 3. On-Resistance vs. Gate Voltage

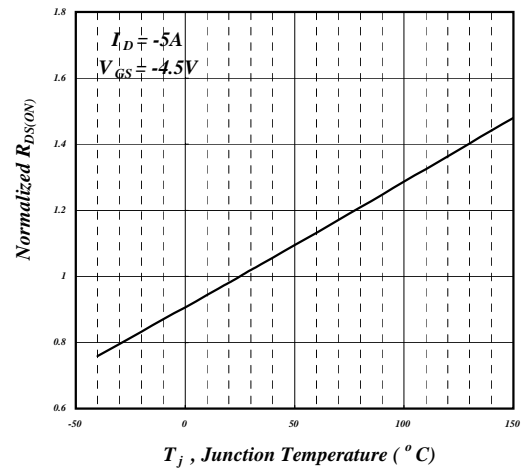

Fig 4. Normalized On-Resistance vs. Junction Temperature

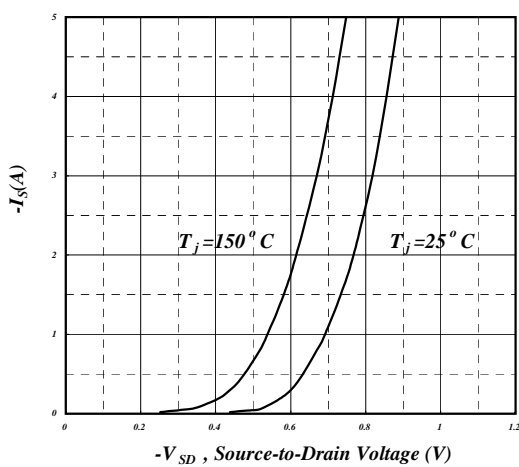

Fig 5. Forward Characteristic of Reverse Diode

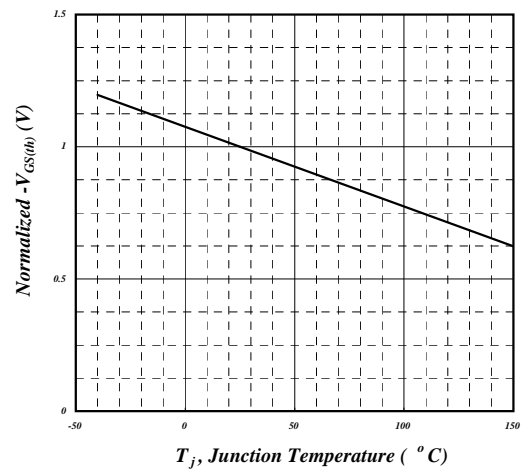

Fig 6. Gate Threshold Voltage vs. Junction Temperature



Typical Electrical Characteristics (cont.)

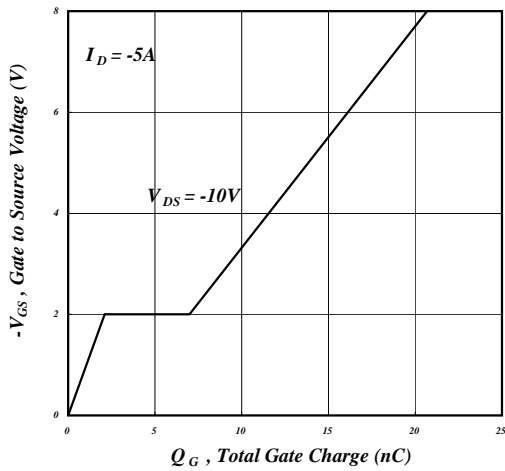

Fig 7. Gate Charge Characteristics

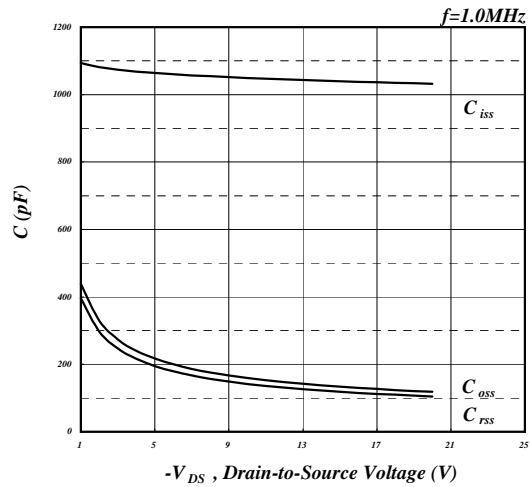

Fig 8. Typical Capacitance Characteristics

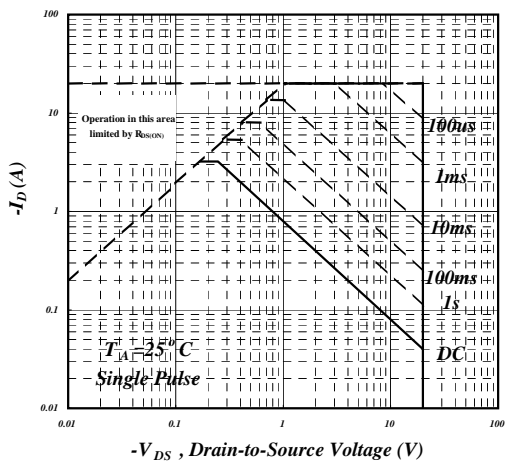

Fig 9. Maximum Safe Operating Area

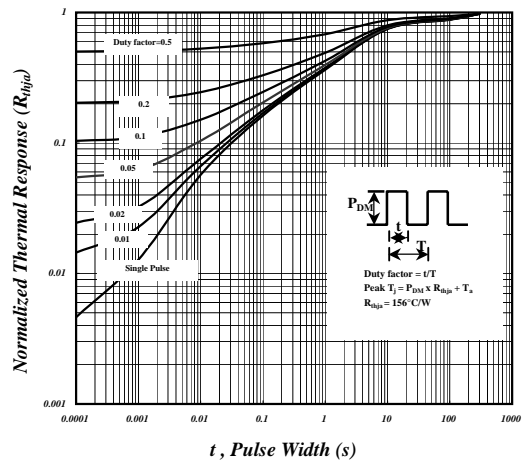

Fig 10. Effective Transient Thermal Impedance

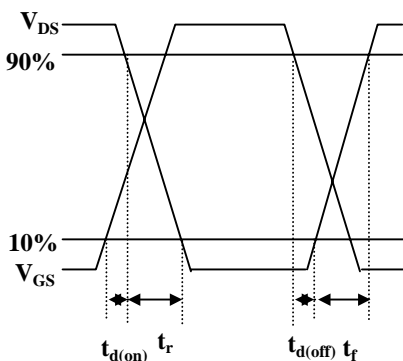

Fig 11. Switching Time Waveforms

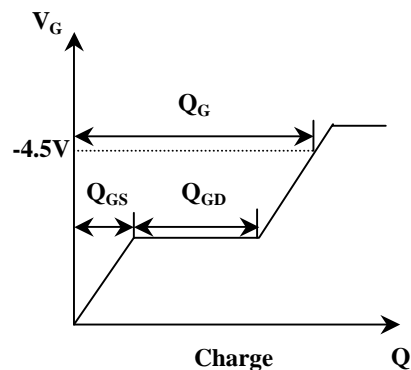
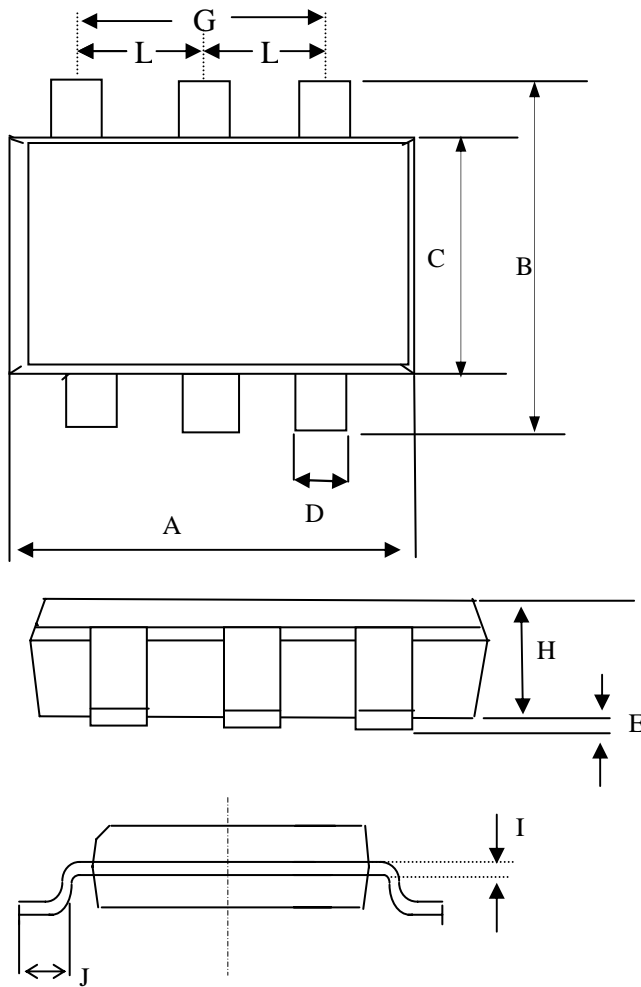

Fig 12. Gate Charge Waveform



Package Dimensions: SOT-26



SYMBOLS	Millimeters		
	MIN	NOM	MAX
A	2.70	2.90	3.10
B	2.60	2.80	3.00
C	1.40	1.60	1.80
D	0.30	0.43	0.55
E	0.00	0.05	0.10
H	1.20REF		
G	1.90REF		
I	0.12REF		
J	0.37REF		
L	0.95REF		

1. All dimensions are in millimeters.
2. Dimensions do not include mold protrusions.

Marking Information:

Laser Marking

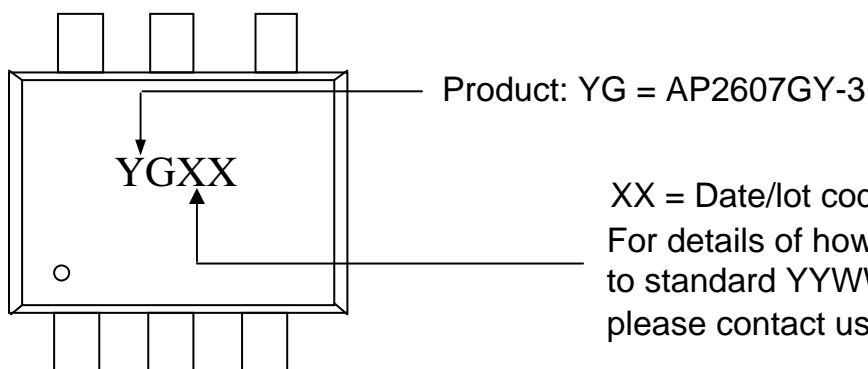

XX = Date/lot code  
 For details of how to convert this to standard YYWW date code format, please contact us directly.

[www.s-manuals.com](http://www.s-manuals.com)