

STANDALONE LINEAR LI-ION BATTERY CHARGER WITH THERMAL REGULATION IN THINSOT

■ DESCRIPTION

The AP4054 is a complete constant-current/constant-voltage linear charger for single cell lithium-ion batteries. Its ThinSOT package and low external component count make the AP4054 ideally suited for portable applications. Furthermore, the AP4054 is specifically designed to work within USB power specifications.

No external sense resistor is needed, and no blocking diode is required due to the internal MOSFET architecture. Thermal feedback regulates the charge current to limit the die temperature during high power operation or high ambient temperature. The charge voltage is fixed at 4.2V, and the charge current can be programmed externally with a single resistor. The AP4054 automatically terminates the charge cycle when the charge current drops to 1/10th the programmed value after the final float voltage is reached.

When the input supply (wall adapter or USB supply) is removed, the AP4054 automatically enters a low current state, dropping the battery drain current to less than 2 μ A. The AP4054 can be put into shutdown mode, reducing the supply current to 25 μ A.

Other features include charge current monitor, under-voltage lockout, automatic recharge and a status pin to indicate charge termination and the presence of an input voltage.

■ FEATURES

- Programmable Charge Current Up to 800mA
- No MOSFET, Sense Resistor or Blocking Diode Required
- Complete Linear Charger in ThinSOT Package for single Cell Lithium-Ion Batteries
- Constant-Current/Constant-Voltage Operation with Thermal Regulation to Maximize Charge Rate Without Risk of Overheating
- Charges Single Cell Li-Ion Batteries Directly from USB Port
- Preset 4.2V Charge Voltage with $\pm 1\%$ Accuracy
- Charge Current Monitor Output for Gas Gauging
- Automatic Recharge
- Charge Status Output Pin
- C/10 Charge Termination
- 25 μ A Supply Current in Shutdown
- 2.9V Trickle Charge Threshold
- Soft-Start Limits Inrush Current
- Available in 5-Lead SOT-23 Package

■ APPLICATIONS

- Cellular Telephones, PDAs, MP3 Players
- Charging Docks and Cradles
- Bluetooth Applications

■ PACKAGE

- SOT-23-5

■ BLOCK DIAGRAM

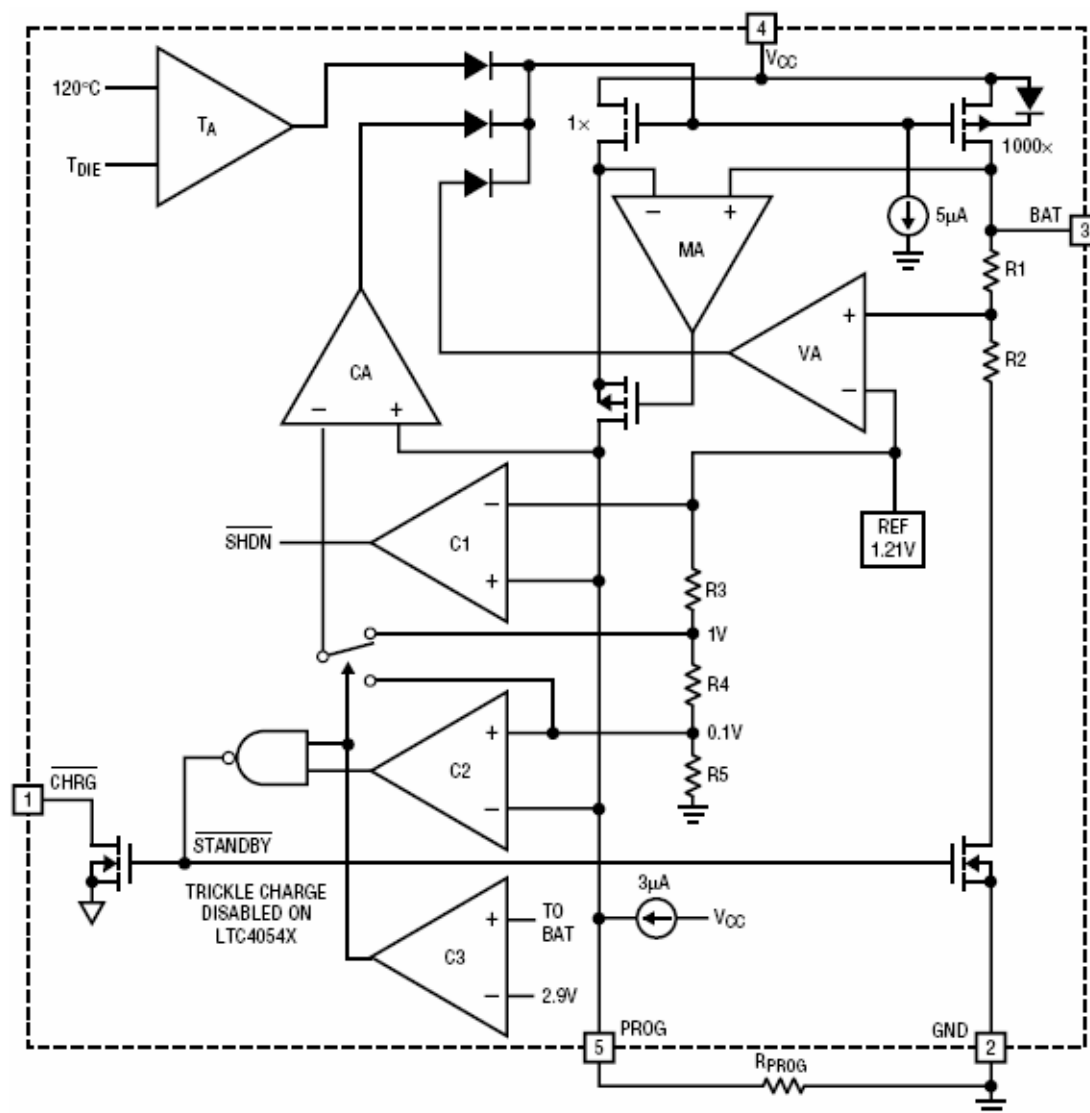

Figure 1

■ ABSOLUTE MAXIMUM RATINGS

PARAMETER	SYMBOL	MAXIMUM RATING	UNIT
Input Supply Voltage	V_{CC}	$V_{SS}-0.3 \sim V_{SS}+10$	V
PROG pin Voltage	V_{prog}	$V_{SS}-0.3 \sim V_{CC}+0.3$	
BAT pin Voltage	V_{bat}	$V_{SS}-0.3 \sim 7$	
CHAG pin Voltage	V_{chrg}	$V_{SS}-0.3 \sim V_{SS}+10$	
BAT pin Current	I_{bat}	800	mA
PROG pin Current	I_{prog}	800	µA
Operating Ambient Temperature	T_{opa}	-40 ~ +85	°C
Storage Temperature	T_{str}	-65 ~ +125	

Caution: The absolute maximum ratings are rated values exceeding which the product could suffer physical damage. These values must therefore not be exceeded under any conditions.

■ Electrical Characteristics

Parameter	Symbol	CONDITION	MIN	TYP	MAX	UNIT
Input supply voltage	Vcc		4.25		6.5	V
Input supply current	Icc	Charge mode, Rprog=10K		300	2000	uA
		Standby mode		200	500	uA
		Shutdown mode(Rprog not connected, Vcc<Vbat or Vcc<Vuv)		25	50	uA
Regulated Output Voltage	Vfloat	0°C ≤ TA ≤ 85°C, IBAT = 40mA	4.158	4.2	4.342	V
BAT pin Current	Ibat	Rprog=10k, Current mode	93	100	107	mA
		Rprog=2k, Current mode	465	500	535	mA
		Standby mode, Vbat=4.2V	0	-2.5	-6	uA
		Shutdown mode		±1	±2	uA
		Sleep mode, Vcc=0V		±1	±2	uA
Trickle charge current	Itrikl	Vbat<Vtrikl, Rprog=2k	20	45	70	mA
Trickle charge Threshold Voltage	Vtrikl	Rprog=10K, Vbat Rising	2.8	2.9	3.0	V
Trickle voltage hysteresis voltage	Vtrhys	Rprog=10k	60	80	110	mV
Vcc Undervoltage lockout Threshold	Vuv	From Vcc low to high	3.7	3.8	3.93	V
Vcc undervoltage lockout hysteresis	Vuvhys		150	200	300	mV
Manual shutdown threshold voltage	Vmsd	PROG pin rising	1.15	1.21	1.30	V
		PROG pin falling	0.9	1.0	1.1	V
Vcc-Vbat Lockout Threshold voltage	Vasd	Vcc from low to high	70	100	140	mV
		Vcc from high to low	5	30	50	mV
C/10 Termination Current Threshold	Iterm	Rprog=10k	0.085	0.10	0.115	mA/mA
		Rprog=2k	0.085	0.10	0.115	mA/mA
PROG pin Voltage	Vprog	Rprog=10k, Current mode	0.93	1.0	1.07	V
CHRG pin weak pull-down Current	Ichrg	Vchrg=5V	8	20	35	uA
CHRG pin Output low voltage	Vchrg	Ichrg=5mA		0.35	0.6	V
Recharge Battery threshold Voltage	Δ Vrecg	VFLOAT - VRECHRG		100	200	mV

■ TYPICAL APPLICATION CIRCUIT

Basic circuit

600mA Single Cell Li-Ion Charger

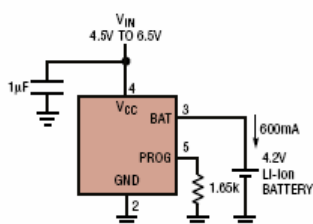

Typical circuit

USB/Wall Adapter Power Li-Ion Charger

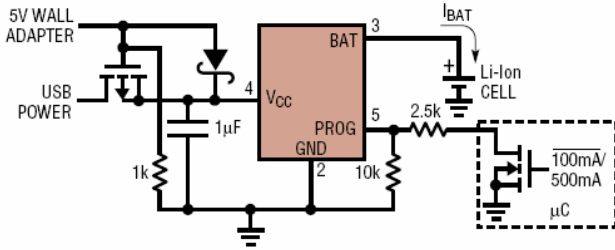

Full Featured Single Cell Li-Ion Charger

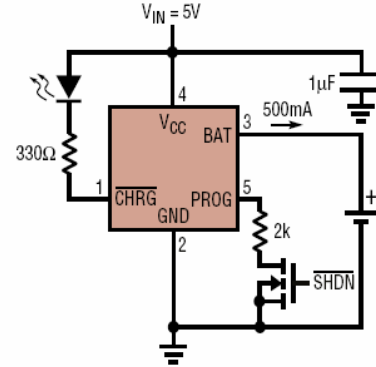

800mA Li-Ion Charger with External Power Dissipation

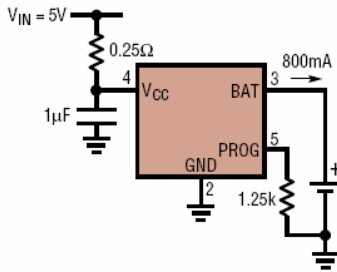

Basic Li-Ion Charger with Reverse Polarity Input Protection

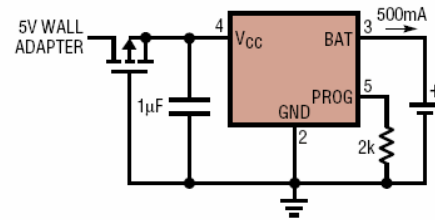

TYPICAL PERFORMANCE CHARACTERISTICS

PROG Pin Voltage vs Supply Voltage (Constant Current Mode)

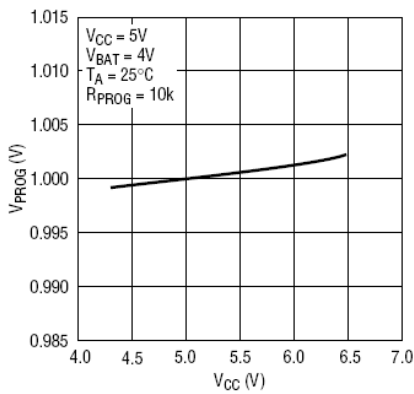

PROG Pin Voltage vs Temperature

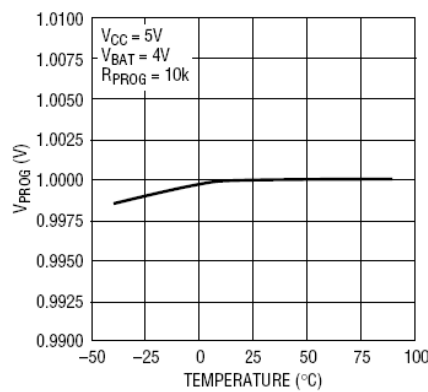

Charge Current vs PROG Pin Voltage

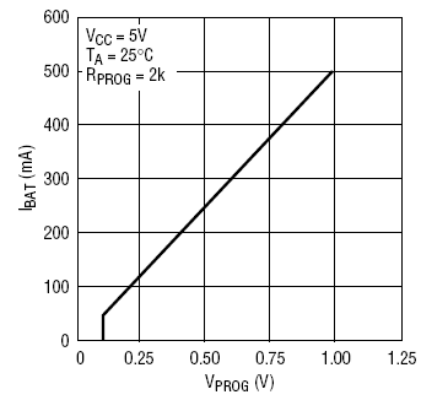

PROG Pin Pull-Up Current vs Temperature and Supply Voltage

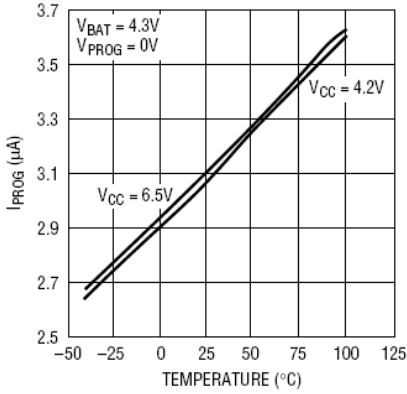

PROG Pin Current vs PROG Pin Voltage (Pull-Up Current)

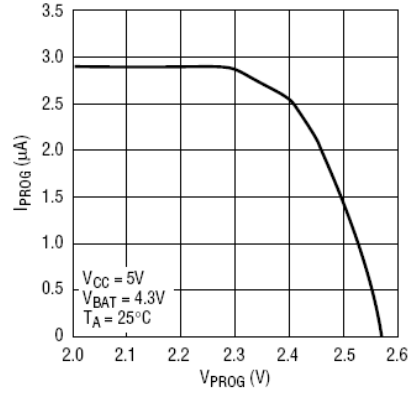

PROG Pin Current vs PROG Pin Voltage (Clamp Current)

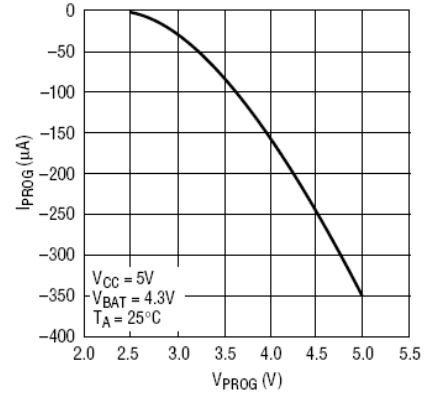

Regulated Output (Float) Voltage vs Charge Current

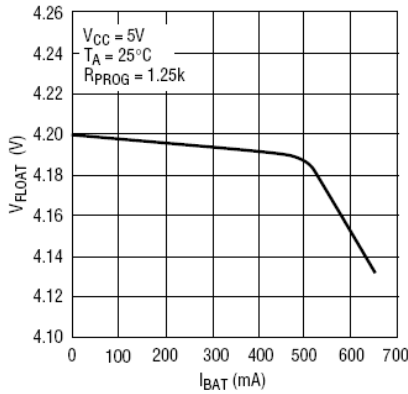

Regulated Output (Float) Voltage vs Temperature

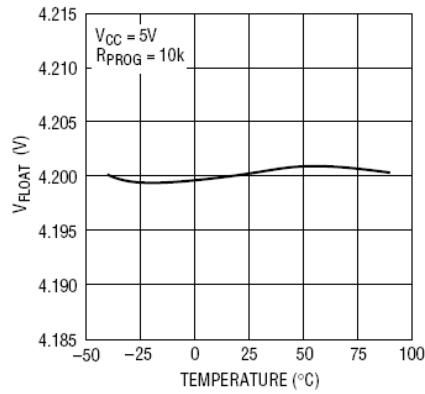

Regulated Output (Float) Voltage vs Supply Voltage

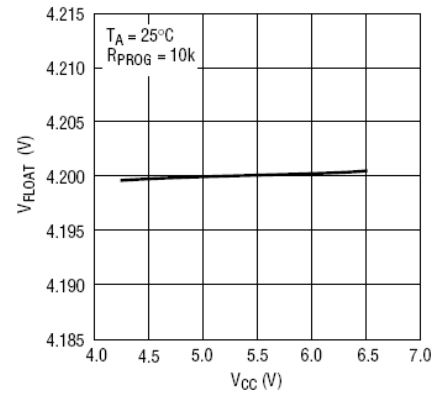

CHRG Pin I-V Curve (Strong Pull-Down State)

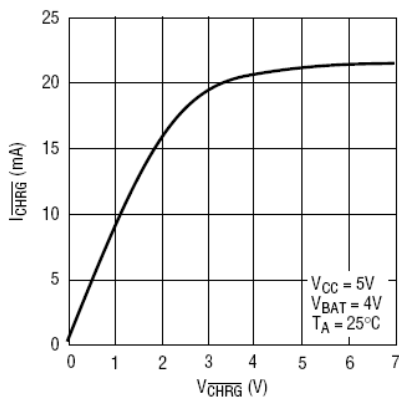

CHRG Pin Current vs Temperature (Strong Pull-Down State)

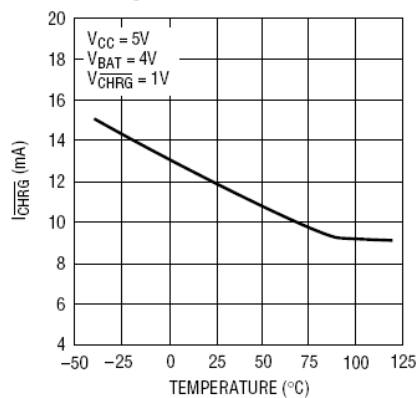

CHRG Pin I-V Curve (Weak Pull-Down State)

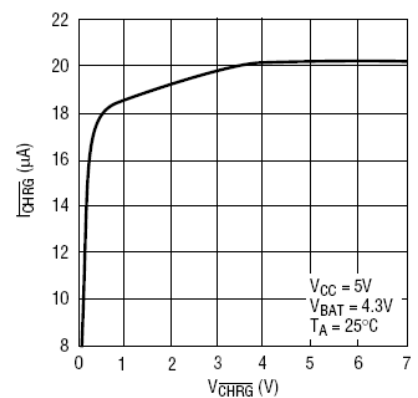

CHRG Pin Current vs Temperature (Weak Pull-Down State)

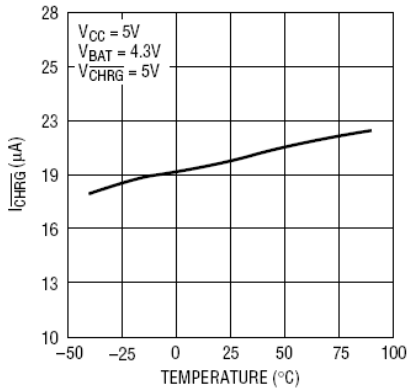

Trickle Charge Current vs Temperature

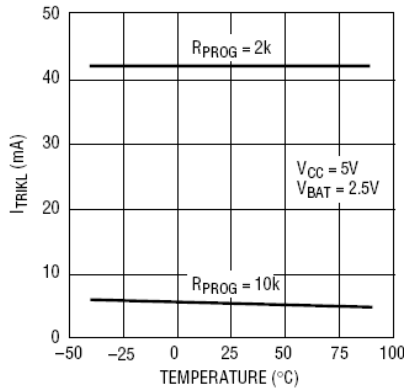

Trickle Charge Current vs Supply Voltage

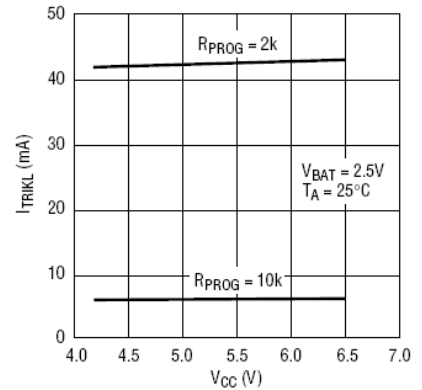

Trickle Charge Threshold vs Temperature

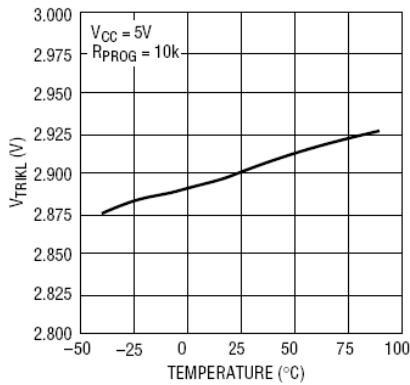

Charge Current vs Battery Voltage

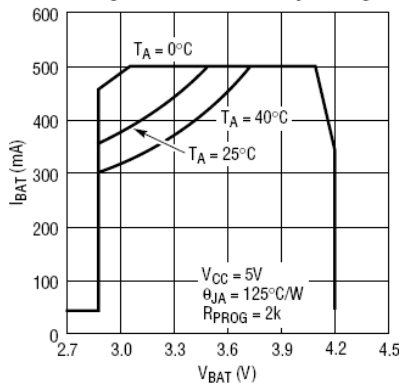

Charge Current vs Supply Voltage

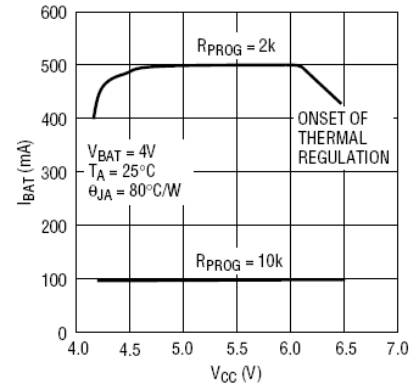

Charge Current vs Ambient Temperature

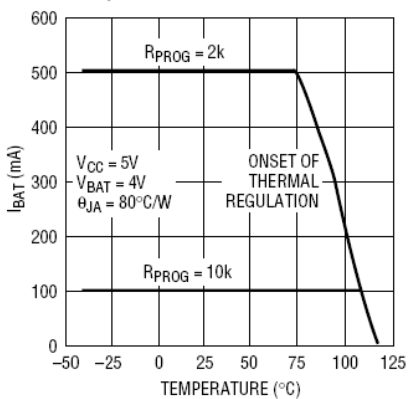

Recharge Voltage Threshold vs Temperature

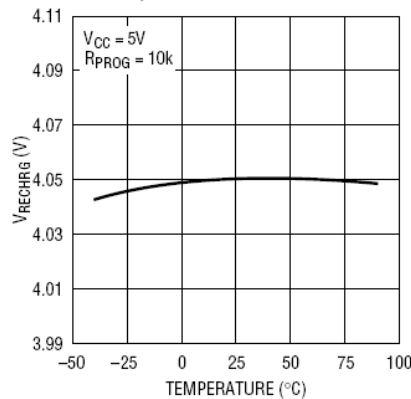

Power FET "ON" Resistance vs Temperature

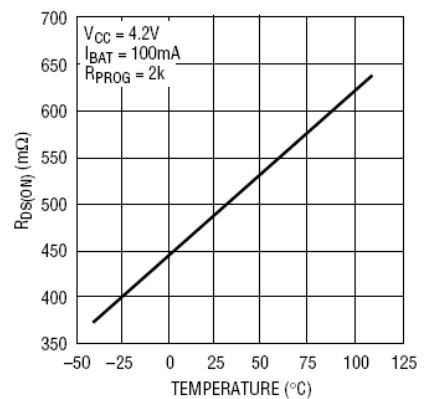

Ordering Information

AP4045①②③④⑤

DESIGNATOR	DESCRIPTION	SYMBOL	DESCRIPTION
①	Type	X	Without trickle charge
		Y	With trickle charge
②	The first part of regulator Output Voltage	0	4.0
		1	4.1
		2	4.2

③	The second part of regulator Output Voltage	A	②00
		B	②25
		C	②50
		D	②75
④	Packaging Types	M	SOT23-5
⑤	Device Orientation	R	Embossed tape: Standard feed
		L	Embossed tape: Reverse feed

MARKING

● SOT23-5

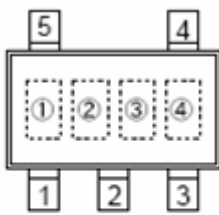

SOT23-5
(TOP VIEW)

① Represents the product name

SYMBOL	PRODUCT NAME
2	AP4054◆◆◆M◆

② Represents the type of the trickle charge voltage

SYMBOL	Product Series
X	AP4054X◆◆M◆
Y	AP4054Y◆◆M◆

③ Represents the regulator output voltage

SYMBOL	Voltage	SYMBOL	Voltage
A	4.0	H	4.150
B	4.025	K	4.175
C	4.05	L	4.2
D	4.075	M	4.225
E	4.1	N	4.250
F	4.125	P	4.275

④ Represents the assembly lot no.

0 to 9, A to Z, reversed character of 0 to 9 and A to Z repeated (G, I, J, O, Q, W excepted)

PIN CONFIGURATION

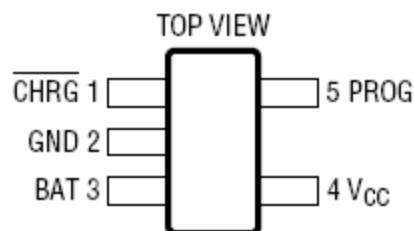

■ PIN ASSIGNMENT

Pin Number	Pin Name
SOT23-5	
1	CHRG
2	GND
3	BAT
4	VCC
5	PROG

■ PIN FUNCTION

CHRG (Pin 1): Open-Drain Charge Status Output. When the battery is charging, the CHRG pin is pulled low by an internal N-channel MOSFET. When the charge cycle is completed, a weak pull-down of approximately 20µA is connected to the CHRG pin, indicating an “AC present” condition. When the AP4054 detects an undervoltage lockout condition, CHRG is forced high impedance.

GND (Pin 2): Ground.

BAT (Pin 3): Charge Current Output. Provides charge current to the battery and regulates the final float voltage to 4.2V. An internal precision resistor divider from this pin sets the float voltage which is disconnected in shutdown mode.

VCC (Pin 4): Positive Input Supply Voltage. Provides power to the charger. VCC can range from 4.25V to 6.5V and should be bypassed with at least a 1µF capacitor. When VCC drops to within 30mV of the BAT pin voltage, the AP4054 enters shutdown mode, dropping IBAT to less than 2µA.

PROG (Pin 5): Charge Current Program, Charge Current Monitor and Shutdown Pin. The charge current is programmed by connecting a 1% resistor, RPROG, to ground. When charging in constant-current mode, this pin serves to 1V. In all modes, the voltage on this pin can be used to measure the charge current using the following formula:

$$IBAT = (VPROG/RPROG) \cdot 1000$$

The PROG pin can also be used to shut down the charger. Disconnecting the program resistor from ground allows a 3µA current to pull the PROG pin high. When it reaches the 1.21V shutdown threshold voltage, the charger enters shutdown mode, charging stops and the input supply current drops to 25µA. This pin is also clamped to approximately 2.4V. Driving this pin to voltages beyond the clamp voltage will draw currents as high as 1.5mA. Reconnecting RPROG to ground will return the charger to normal operation.

■ PACKAGE INFORMATION

● SOT23-5

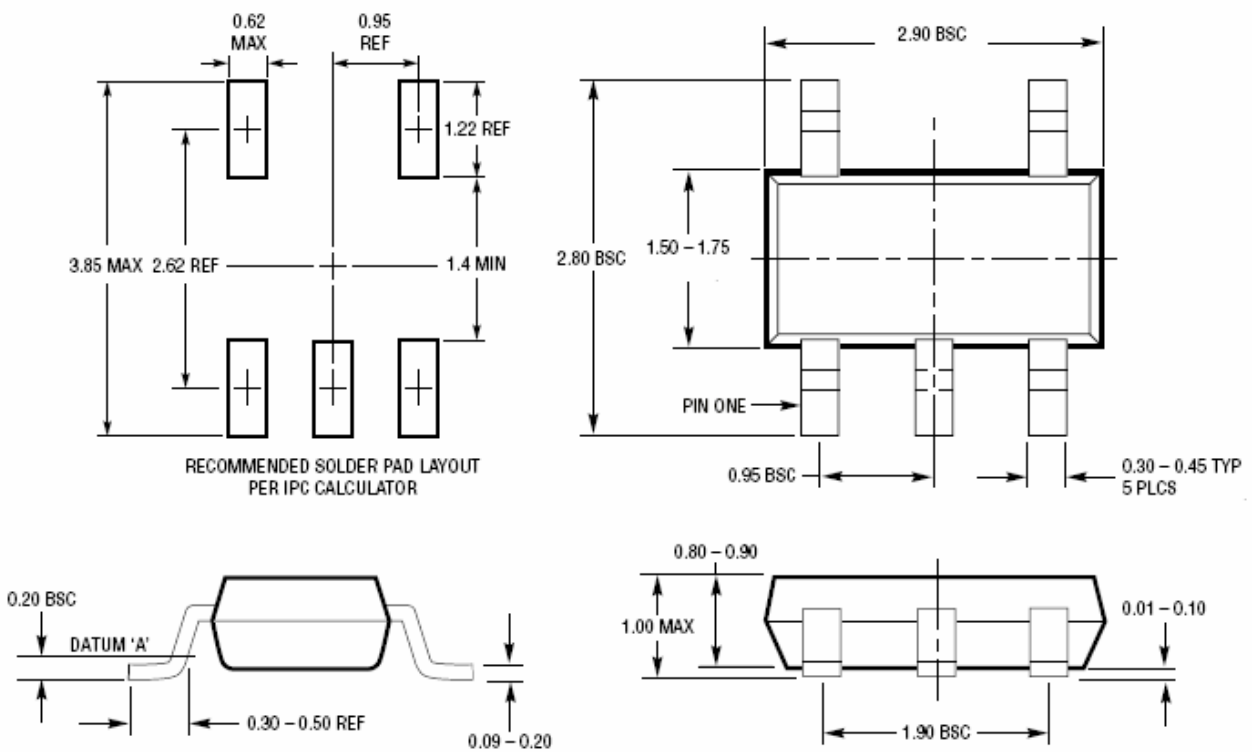

www.s-manuals.com