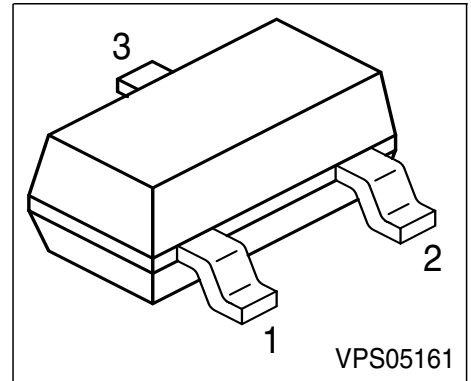
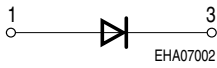
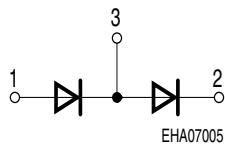
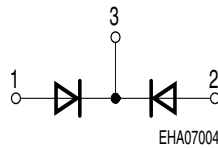
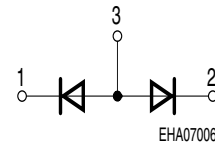

**Silicon RF Switching Diode**

- Low-loss VHF / UHF switch above 10 MHz
- PIN diode with low forward resistance

**BAT 18**

**BAT 18-04**

**BAT 18-05**

**BAT 18-06**

Type	Marking	Pin Configuration			Package
BAT 18	A2s	1 = A	2 n.c.	3 = C	SOT-23
BAT 18-04	AUs	1 = A1	2 = C2	3 = C1/A2	SOT-23
BAT 18-05	ASs	1 = A1	2 = A2	3 = C1/2	SOT-23
BAT 18-06	ATs	1 = C1	2 = C2	3 = A1/2	SOT-23

**Maximum Ratings**

Parameter	Symbol	Value	Unit
Diode reverse voltage	$V_R$	35	V
Forward current	$I_F$	100	mA
Operating temperature range	$T_{op}$	-55 ... 150	°C
Storage temperature	$T_{stg}$	-55 ... 150	

**Thermal Resistance**

Junction - ambient <sup>1)</sup>	$R_{thJA}$	≤ 450	K/W
----------------------------------	------------	-------	-----

1) Package mounted on alumina 15mm x 16.7mm x 0.7mm

**Electrical Characteristics** at  $T_A = 25\text{ }^\circ\text{C}$ , unless otherwise specified.

Parameter	Symbol	Values			Unit
		min.	typ.	max.	
<b>DC characteristics</b>					
Reverse current $V_R = 20\text{ V}$	$I_R$	-	-	20	nA
Reverse current $V_R = 20\text{ V}, T_A = 60\text{ }^\circ\text{C}$	$I_R$	-	-	200	
Forward voltage $I_F = 100\text{ mA}$	$V_F$	-	0.38	1.2	mV
<b>AC characteristics</b>					
Diode capacitance $V_R = 20\text{ V}, f = 1\text{ MHz}$	$C_T$	-	0.75	1	pF
Forward resistance $I_F = 5\text{ mA}, f = 100\text{ MHz}$	$r_f$	-	0.4	0.7	$\Omega$
Series inductance	$L_S$	-	2	-	nH

**Diode capacitance**  $C_T = f(V_R)$

$f = 1\text{ MHz}$

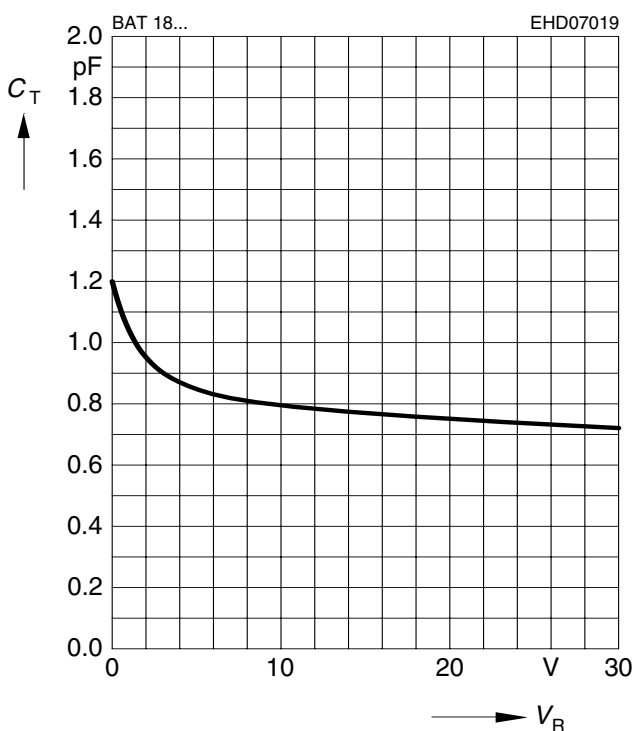

**Forward resistance**  $r_f = f(I_F)$

$f = 100\text{ MHz}$

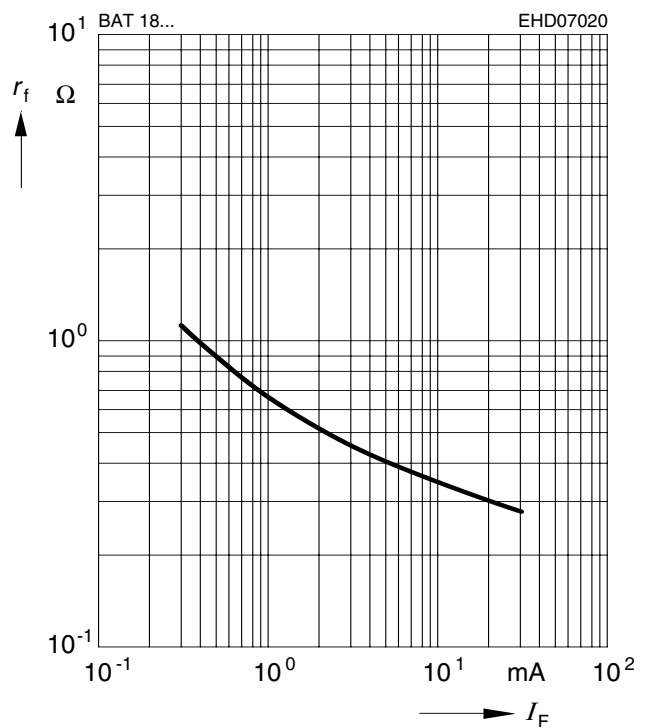

[www.s-manuals.com](http://www.s-manuals.com)