

Surface Mount Fast Switching Diodes

BAV199DW

FEATURES

- Fast switching speed.
- For general purpose switching application.
- Ultra-small surface mount package.



Lead-free

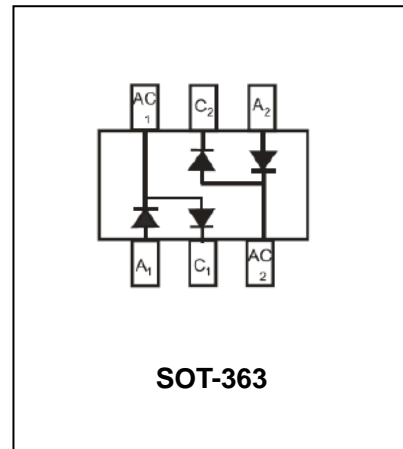

APPLICATIONS

- For general purpose switching application.

ORDERING INFORMATION

Type No.	Marking	Package Code
BAV199DW	K52	SOT-363

MAXIMUM RATING @ Ta=25°C unless otherwise specified

Symbol	Characteristic	Value	Unit
V_R	DC reverse voltage	85	V
I_{FM}	Forward continuous current	200	mA
I_O	Average rectified output current	150	mA
P_D	Power Dissipation	200	mW
$R_{\theta JA}$	Thermal Resistance, Junction to Ambient	625	°C/W
T_j, T_{stg}	Junction and Storage Temperature	-65 to+150	°C

ELECTRICAL CHARACTERISTICS @ Ta=25°C unless otherwise specified

Surface Mount Fast Switching Diodes

BAV199DW

Parameter	Symbol	Test conditions	MIN	MAX	UNIT
Reverse breakdown voltage	$V_{(BR)R}$	$I_R=100\mu A$	85	-	V
Forward voltage	V_F	$I_F=1.0mA$ $I_F=10mA$ $I_F=50mA$ $I_F=150mA$	-	0.9 1.0 1.1 1.25	V
Junction Capacitance	C_J	$V_R=0V, f=1.0MHz$	-	2.0	pF
Reverse Recovery time	t_{rr}	$I_F=I_R=10mA, I_{rr}=0.1*I_R, R_L=100\Omega$	-	3.0	ns

TYPICAL CHARACTERISTICS @ $T_a=25^\circ C$ unless otherwise specified

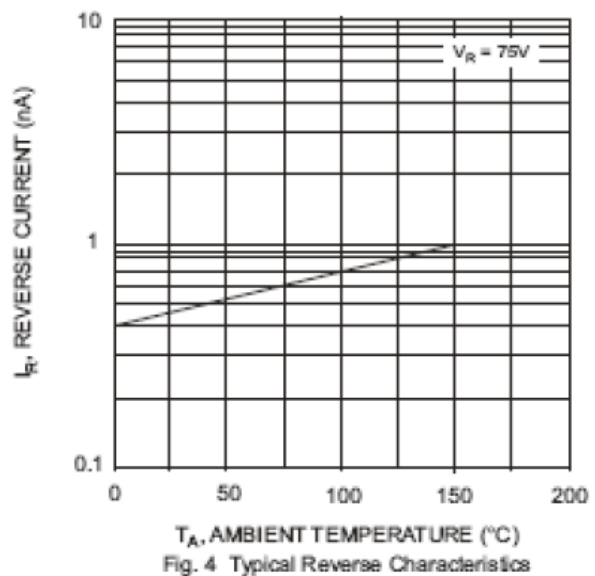
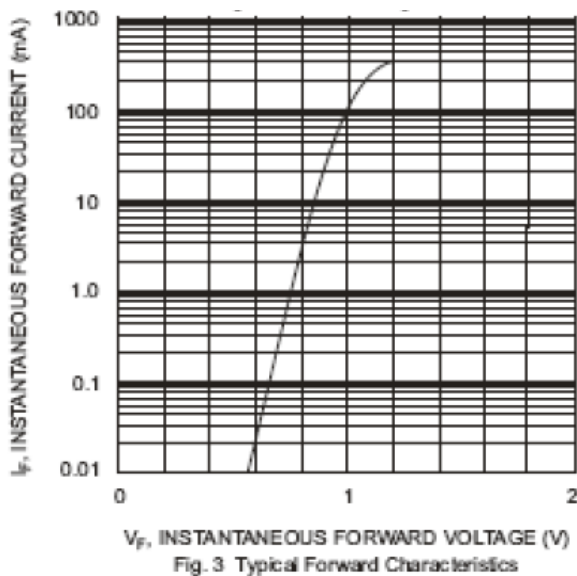
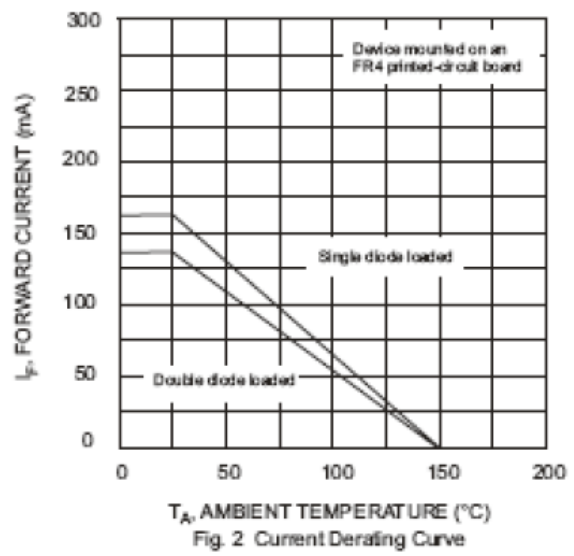
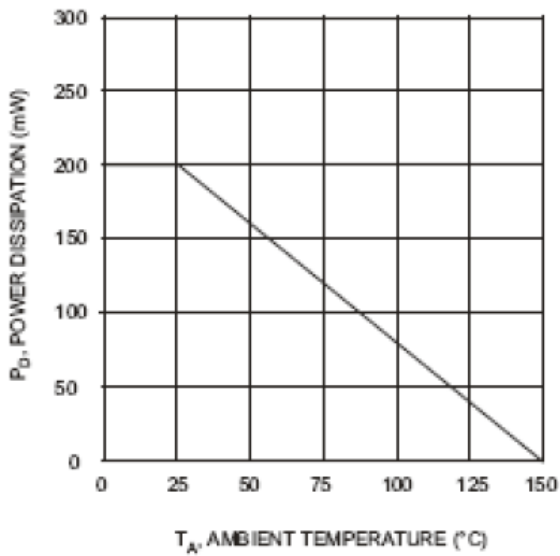

Surface Mount Fast Switching Diodes

BAV199DW

PACKAGE OUTLINE

Plastic surface mounted package

SOT-363

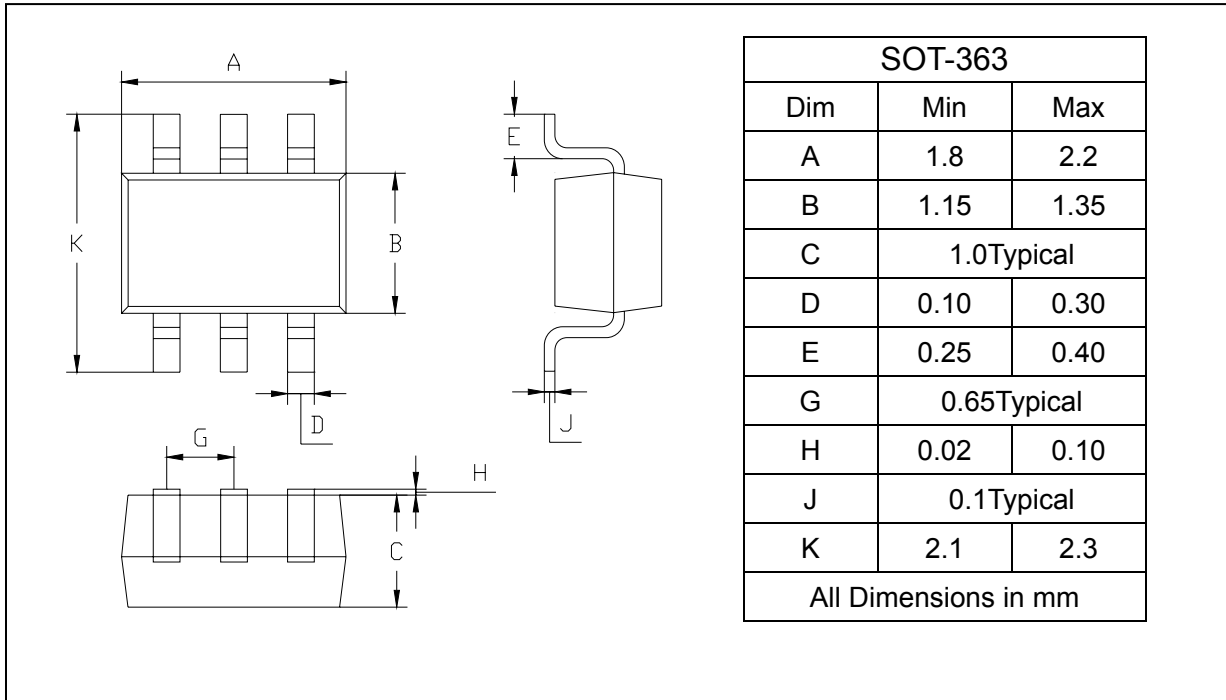

SOLDERING FOOTPRINT

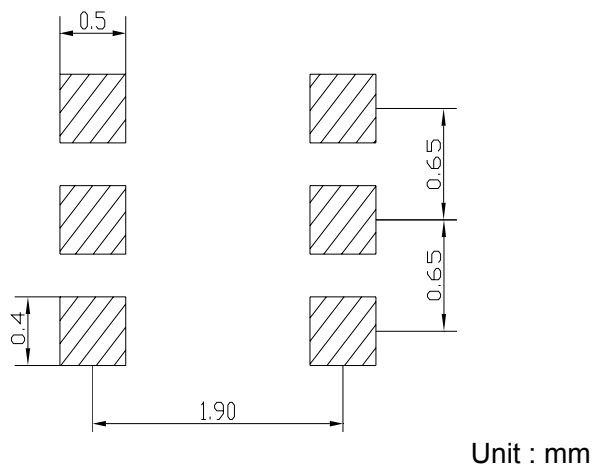

PACKAGE INFORMATION

Device	Package	Shipping
BAV199DW	SOT-363	3000/Tape&Reel

www.s-manuals.com