

## Surface Mount Fast Switching Diodes

## BAV99DW

### FEATURES

- Fast switching speed.
- For general purpose switching application.
- Ultra-small surface mount package.
- High conductance.
- Two “BAV99” circuits in one package.



Lead-free

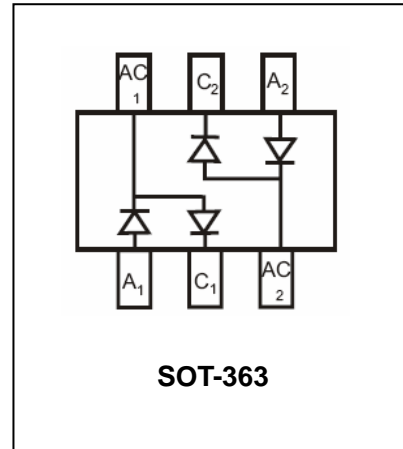

### APPLICATIONS

- For general purpose switching application.

### ORDERING INFORMATION

Type No.	Marking	Package Code
BAV99DW	KJG	SOT-363

### MAXIMUM RATING @ Ta=25°C unless otherwise specified

Symbol	Characteristic	Value	Unit
$V_{RM}$	Non-repetitive peak reverse voltage	100	V
$V_{RRM}$ $V_{RWM}$ $V_R$	Peak repetitive reverse voltage Working peak reverse voltage DC reverse voltage	75	V
$V_{R(RMS)}$	RMS Reverse voltage	53	V
$I_{FM}$	Forward continuous current	215	mA
$I_{FSM}$	Non-repetitive peak forward surge current @t=1.0μs @t=1.0ms @t=1.0s	2.0 1.0 0.5	A
$P_D$	Power Dissipation	200	mW
$R_{\theta JA}$	Thermal Resistance, Junction to Ambient	417	°C/W
$T_j, T_{stg}$	Junction and Storage Temperature	-65 to +150	°C

## Surface Mount Fast Switching Diodes

## BAV99DW

### ELECTRICAL CHARACTERISTICS @ Ta=25°C unless otherwise specified

Parameter	Symbol	Test conditions	MIN	MAX	UNIT
Reverse breakdown voltage	$V_{(BR)R}$	$I_R=2.5\mu A$	75	-	V
Forward voltage	$V_F$	$I_F=1.0mA$ $I_F=10mA$ $I_F=50mA$ $I_F=150mA$	-	0.715 0.855 1.0 1.25	V
Junction Capacitance	$C_J$	$V_R=0V, f=1.0MHz$	-	2.0	pF
Reverse Recovery time	$t_{rr}$	$I_F=I_R=10mA, I_{rr}=0.1 \cdot I_R,$ $R_L=100\Omega$	-	4.0	ns

### TYPICAL CHARACTERISTICS @ Ta=25°C unless otherwise specified

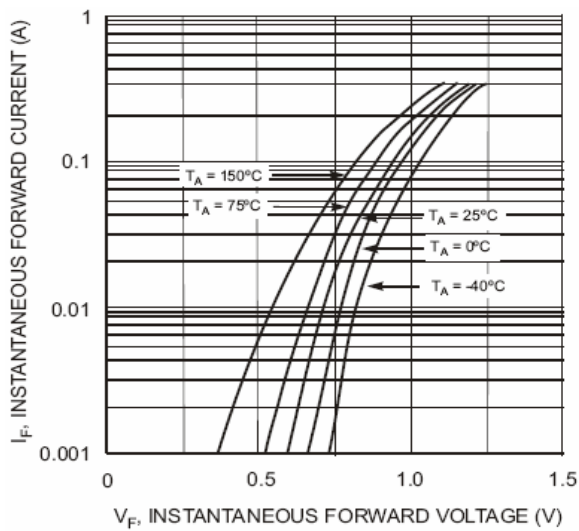

Fig. 1 Forward Characteristics

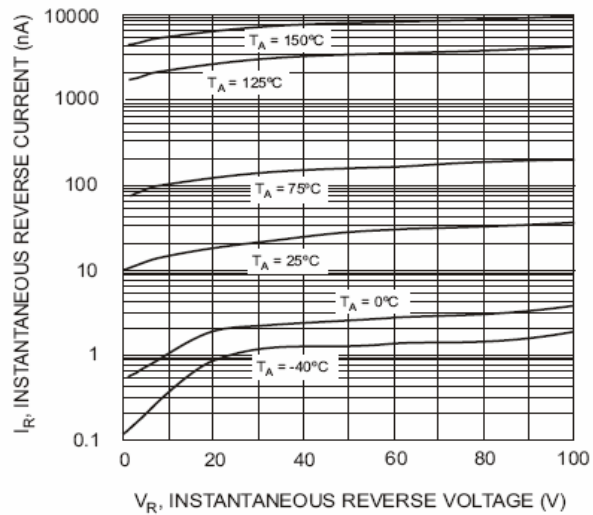

Fig. 2 Typical Reverse Characteristics

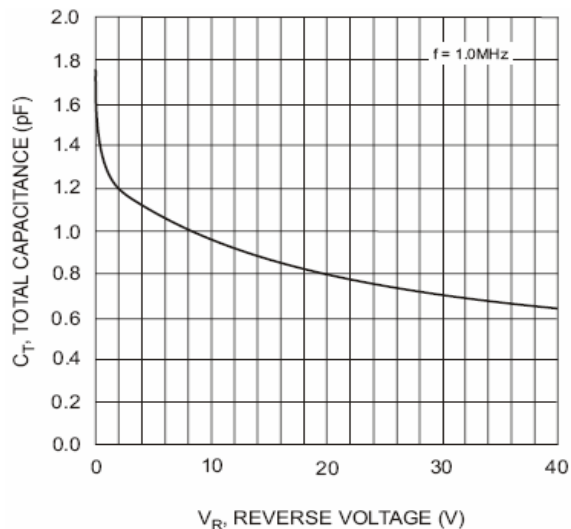

Fig. 3 Typical Capacitance vs. Reverse Voltage

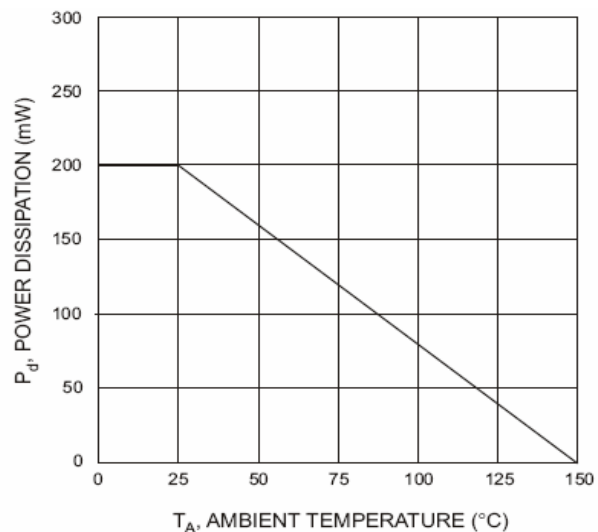

Fig. 4 Power Derating Curve

## Surface Mount Fast Switching Diodes

## BAV99DW

### PACKAGE OUTLINE

Plastic surface mounted package

SOT-363

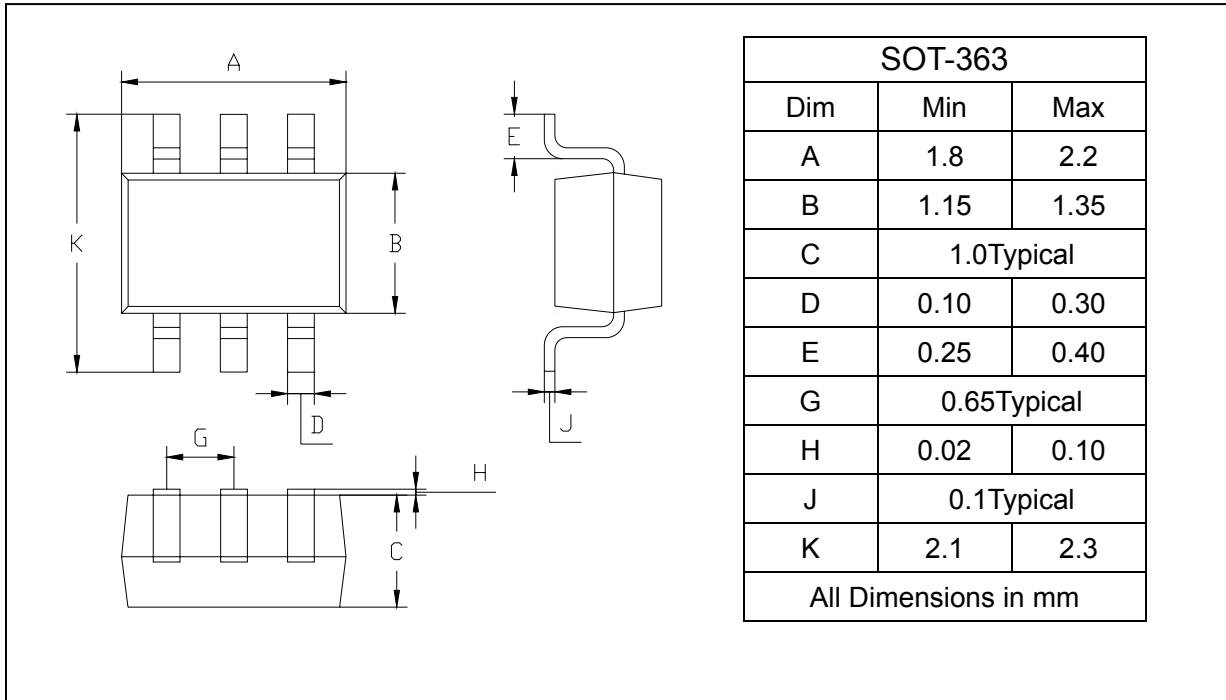

### SOLDERING FOOTPRINT

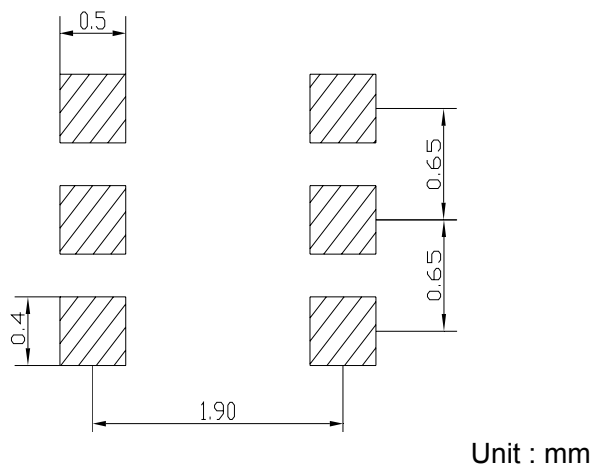

### PACKAGE INFORMATION

Device	Package	Shipping
BAV99DW	SOT-363	3000/Tape&Reel

[www.s-manuals.com](http://www.s-manuals.com)