

BC856- BC860

PNP Epitaxial Silicon Transistor

Features

- Switching and Amplifier Applications
- Suitable for automatic insertion in thick and thin-film circuits
- Low Noise: BC859, BC860
- Complement to BC846 ... BC850

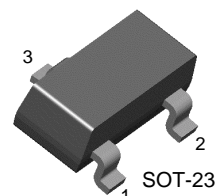

1. Base 2. Emitter 3. Collector

Absolute Maximum Ratings* $T_a = 25^\circ\text{C}$ unless otherwise noted

Symbol	Parameter	Value	Units
V_{CB0}	Collector-Base Voltage		
	: BC856	-80	V
	: BC857/860	-50	V
	: BC858/859	-30	V
V_{CEO}	Collector-Emitter Voltage		
	: BC856	-65	V
	: BC857/860	-45	V
	: BC858/859	-30	V
V_{EBO}	Emitter-Base Voltage	-5	V
I_C	Collector Current (DC)	-100	mA
P_C	Collector Power Dissipation	310	mW
T_J	Junction Temperature	150	$^\circ\text{C}$
T_{STG}	Storage Temperature	-65 ~ 150	$^\circ\text{C}$

* These ratings are limiting values above which the serviceability of any semiconductor device may be impaired.

Electrical Characteristics* $T_a = 25^\circ\text{C}$ unless otherwise noted

Symbol	Parameter	Test Condition	Min.	Typ.	Max.	Units
I_{CBO}	Collector Cut-off Current	$V_{CB} = -30\text{V}, I_E = 0$			-15	nA
h_{FE}	DC Current Gain	$V_{CE} = -5\text{V}, I_C = -2\text{mA}$	110		800	
$V_{CE}(\text{sat})$	Collector-Emitter Saturation Voltage	$I_C = -10\text{mA}, I_B = -0.5\text{mA}$		-90	-300	mV
		$I_C = -100\text{mA}, I_B = -5\text{mA}$		-250	-650	mV
$V_{BE}(\text{sat})$	Base-Emitter Saturation Voltage	$I_C = -10\text{mA}, I_B = -0.5\text{mA}$		-700		mV
		$I_C = -100\text{mA}, I_B = -5\text{mA}$		-900		mV
$V_{BE}(\text{on})$	Base-Emitter On Voltage	$V_{CE} = -5\text{V}, I_C = -2\text{mA}$	-600	-660	-750	mV
		$V_{CE} = -5\text{V}, I_C = -10\text{mA}$			-800	mV
f_T	Current Gain Bandwidth Product	$V_{CE} = -5\text{V}, I_C = -10\text{mA}$ $f = 100\text{MHz}$		150		MHz
C_{ob}	Output Capacitance	$V_{CB} = -10\text{V}, I_E = 0, f = 1\text{MHz}$			6	pF
NF	Noise Figure	: BC856/857/858 : BC859/860	$V_{CE} = -5\text{V}, I_C = -200\mu\text{A}$ $R_G = 2\text{K}\Omega, f = 1\text{KHz}$	2	10	dB
				1	4	dB
		: BC859 : BC860	$V_{CE} = -5\text{V}, I_C = -200\mu\text{A}$ $R_G = 2\text{K}\Omega, f = 30 \sim 15000\text{Hz}$	1.2	4	dB
				1.2	2	dB

* Pulse Test: Pulse Width $\leq 300\mu\text{s}$, Duty Cycle $\leq 2\%$

h_{FE} Classification

Classification	A	B	C
h _{FE}	110 ~ 220	200 ~ 450	420 ~ 800

Ordering Information

Device ^(note1)	Device Marking	Package	Packing Method	Qty(pcs)	Pin Difinitions
BC856AMTF	9AA	SOT-23	Tape & Reel	3000	1.Base 2.Emitter 3.Collector
BC856BMTF	9AB	SOT-23	Tape & Reel	3000	1.Base 2.Emitter 3.Collector
BC856CMTF	9AC	SOT-23	Tape & Reel	3000	1.Base 2.Emitter 3.Collector
BC857AMTF	9BA	SOT-23	Tape & Reel	3000	1.Base 2.Emitter 3.Collector
BC857BMTF	9BB	SOT-23	Tape & Reel	3000	1.Base 2.Emitter 3.Collector
BC857CMTF	9BC	SOT-23	Tape & Reel	3000	1.Base 2.Emitter 3.Collector
BC858AMTF	9CA	SOT-23	Tape & Reel	3000	1.Base 2.Emitter 3.Collector
BC858BMTF	9CB	SOT-23	Tape & Reel	3000	1.Base 2.Emitter 3.Collector
BC858CMTF	9CC	SOT-23	Tape & Reel	3000	1.Base 2.Emitter 3.Collector
BC859AMTF	9DA	SOT-23	Tape & Reel	3000	1.Base 2.Emitter 3.Collector
BC859BMTF	9DB	SOT-23	Tape & Reel	3000	1.Base 2.Emitter 3.Collector
BC859CMTF	9DC	SOT-23	Tape & Reel	3000	1.Base 2.Emitter 3.Collector
BC860AMTF	9EA	SOT-23	Tape & Reel	3000	1.Base 2.Emitter 3.Collector
BC860BMTF	9EB	SOT-23	Tape & Reel	3000	1.Base 2.Emitter 3.Collector
BC860CMTF	9EC	SOT-23	Tape & Reel	3000	1.Base 2.Emitter 3.Collector

Note1 : Affix "-A,-B,-C" means hFE classification.

Affix "-M" means the matte type package.

Affix "-TF" means the tape & reel type packing.

Typical Performance Characteristics

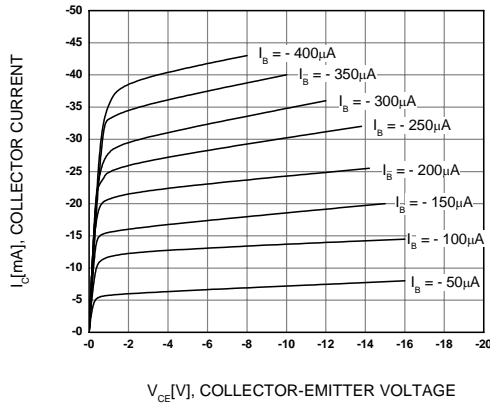

Figure 1. Static Characteristic

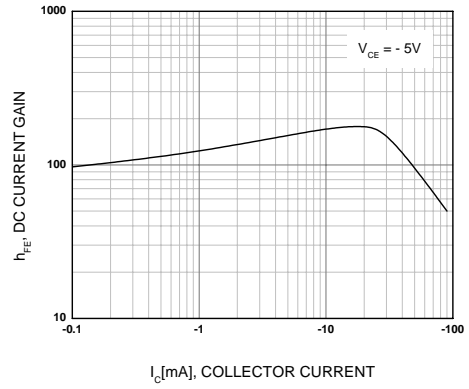

Figure 2. DC current Gain

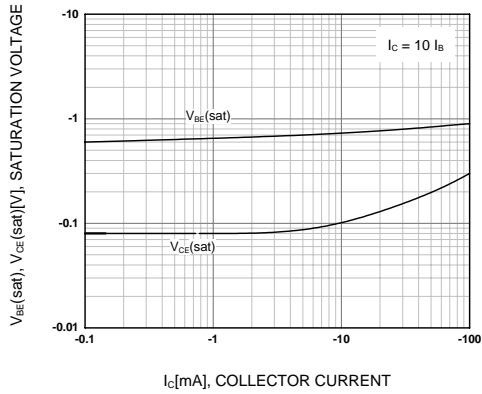

Figure 3. Base-Emitter Saturation Voltage
Collector-Emitter Saturation Voltage

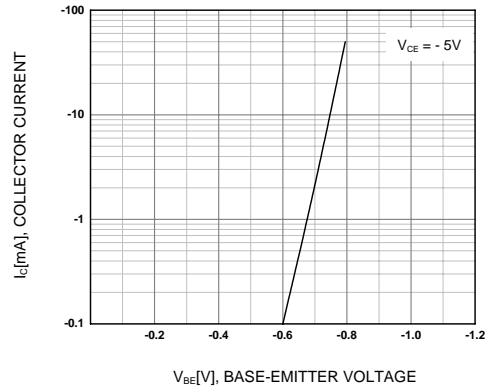

Figure 4. Base-Emitter On Voltage

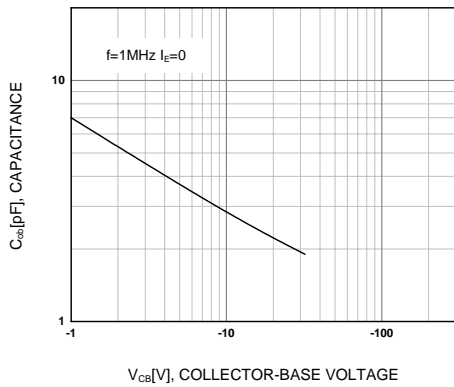

Figure 5. Collector Output Capacitance

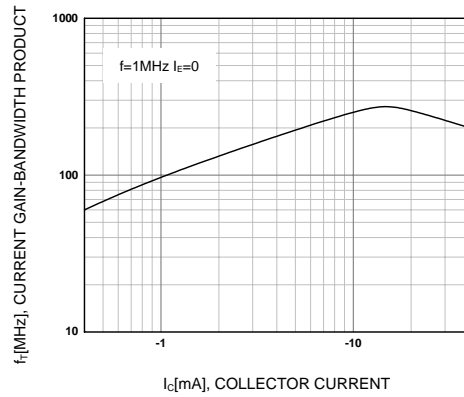
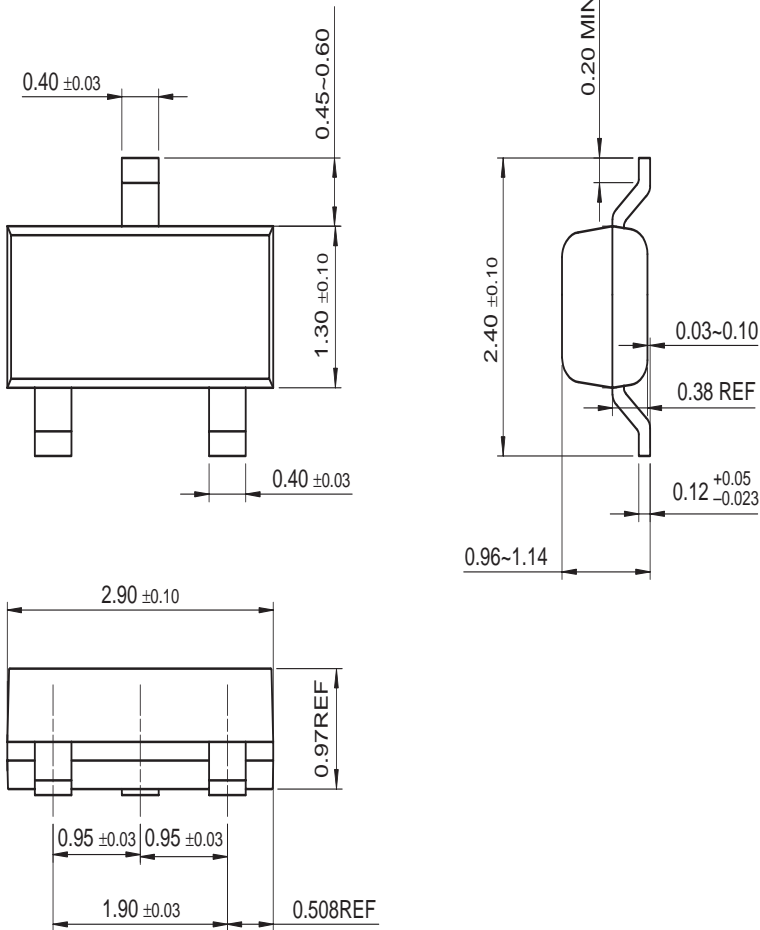

Figure 6. Current Gain Bandwidth Product

Mechanical Dimensions

SOT-23



Dimensions in Millimeters

TRADEMARKS

The following are registered and unregistered trademarks Fairchild Semiconductor owns or is authorized to use and is not intended to be an exhaustive list of all such trademarks.

ACE ^x TM	FACT Quiet Series TM	OCX TM	SILENT SWITCHER [®]	UltraFET [®]
ActiveArray TM	GlobalOptoisolator TM	OCXPro TM	SMART START TM	UniFET TM
Bottomless TM	GTO TM	OPTOLOGIC [®]	SPM TM	VCX TM
Build it Now TM	HiSeC TM	OPTOPLANAR TM	Stealth TM	Wire TM
CoolFET TM	I ² C TM	PACMAN TM	SuperFET TM	
CROSSVOLT TM	i-Lo TM	POP TM	SuperSOT TM -3	
DOME TM	ImpliedDisconnect TM	Power247 TM	SuperSOT TM -6	
EcoSPARK TM	IntelliMAX TM	PowerEdge TM	SuperSOT TM -8	
E ² CMOS TM	ISOPLANAR TM	PowerSaver TM	SyncFET TM	
EnSigna TM	LittleFET TM	PowerTrench [®]	TCM TM	
FACT TM	MICROCOUPLER TM	QFET [®]	TinyBoost TM	
FAST [®]	MicroFET TM	QS TM	TinyBuck TM	
FAST _r TM	MicroPak TM	QT Optoelectronics TM	TinyPWM TM	
FPS TM	MICROWIRE TM	Quiet Series TM	TinyPower TM	
FRFET TM	MSX TM	RapidConfigure TM	TinyLogic [®]	
	MSXPro TM	RapidConnect TM	TINYOPTO TM	
Across the board. Around the world. TM		μSerDes TM	TruTranslation TM	
The Power Franchise [®]		ScalarPump TM	UHC TM	
Programmable Active Droop TM				

DISCLAIMER

FAIRCHILD SEMICONDUCTOR RESERVES THE RIGHT TO MAKE CHANGES WITHOUT FURTHER NOTICE TO ANY PRODUCTS HEREIN TO IMPROVE RELIABILITY, FUNCTION OR DESIGN. FAIRCHILD DOES NOT ASSUME ANY LIABILITY ARISING OUT OF THE APPLICATION OR USE OF ANY PRODUCT OR CIRCUIT DESCRIBED HEREIN; NEITHER DOES IT CONVEY ANY LICENSE UNDER ITS PATENT RIGHTS, NOR THE RIGHTS OF OTHERS. THESE SPECIFICATIONS DO NOT EXPAND THE TERMS OF FAIRCHILD'S WORLDWIDE TERMS AND CONDITIONS, SPECIFICALLY THE WARRANTY THEREIN, WHICH COVERS THESE PRODUCTS.

LIFE SUPPORT POLICY

FAIRCHILD'S PRODUCTS ARE NOT AUTHORIZED FOR USE AS CRITICAL COMPONENTS IN LIFE SUPPORT DEVICES OR SYSTEMS WITHOUT THE EXPRESS WRITTEN APPROVAL OF FAIRCHILD SEMICONDUCTOR CORPORATION.

As used herein:

1. Life support devices or systems are devices or systems which, (a) are intended for surgical implant into the body, or (b) support or sustain life, or (c) whose failure to perform when properly used in accordance with instructions for use provided in the labeling, can be reasonably expected to result in significant injury to the user.
2. A critical component is any component of a life support device or system whose failure to perform can be reasonably expected to cause the failure of the life support device or system, or to affect its safety or effectiveness.

PRODUCT STATUS DEFINITIONS

Definition of Terms

Datasheet Identification	Product Status	Definition
Advance Information	Formative or In Design	This datasheet contains the design specifications for product development. Specifications may change in any manner without notice.
Preliminary	First Production	This datasheet contains preliminary data, and supplementary data will be published at a later date. Fairchild Semiconductor reserves the right to make changes at any time without notice in order to improve design.
No Identification Needed	Full Production	This datasheet contains final specifications. Fairchild Semiconductor reserves the right to make changes at any time without notice in order to improve design.
Obsolete	Not In Production	This datasheet contains specifications on a product that has been discontinued by Fairchild semiconductor. The datasheet is printed for reference information only.

Rev. I20

www.s-manuals.com