

**NPN Silicon Digital Transistor Array**

- Switching circuit, inverter, interface circuit, driver circuit
- Two ( galvanic) internal isolated Transistors with good matching in one package
- Built in bias resistor ( $R_1=47k\Omega$ ,  $R_2=47k\Omega$ )

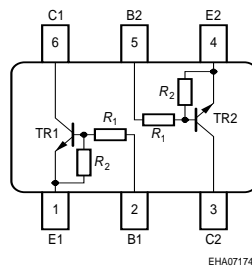
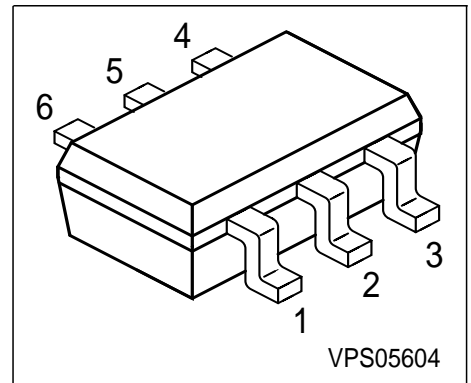

Type	Marking	Pin Configuration				Package		
BCR148S	WEs	1=E1	2=B1	3=C2	4=E2	5=B2	6=C1	SOT363

**Maximum Ratings**

Parameter	Symbol	Value	Unit
Collector-emitter voltage	$V_{CEO}$	50	V
Collector-base voltage	$V_{CBO}$	50	
Emitter-base voltage	$V_{EBO}$	10	
Input on Voltage	$V_{i(on)}$	50	
DC collector current	$I_C$	70	mA
Total power dissipation, $T_S = 115\text{ °C}$	$P_{tot}$	250	
Junction temperature	$T_j$	150	°C
Storage temperature	$T_{stg}$	-65 ... 150	

**Thermal Resistance**

Junction - soldering point <sup>1)</sup>	$R_{thJS}$	≤ 140	K/W
--	------------	-------	-----

<sup>1</sup>For calculation of  $R_{thJA}$  please refer to Application Note Thermal Resistance

**Electrical Characteristics** at  $T_A=25^\circ\text{C}$ , unless otherwise specified

Parameter	Symbol	Values			Unit
		min.	typ.	max.	
<b>DC Characteristics</b>					
Collector-emitter breakdown voltage $I_C = 100 \mu\text{A}, I_B = 0$	$V_{(BR)CEO}$	50	-	-	V
Collector-base breakdown voltage $I_C = 10 \mu\text{A}, I_E = 0$	$V_{(BR)CBO}$	50	-	-	
Emitter-base breakdown voltage $I_E = 10 \mu\text{A}, I_C = 0$	$V_{(BR)EBO}$	-	-	-	
Collector cutoff current $V_{CB} = 40 \text{ V}, I_E = 0$	$I_{CBO}$	-	-	100	nA
Emitter cutoff current $V_{EB} = 10 \text{ V}, I_C = 0$	$I_{EBO}$	-	-	164	$\mu\text{A}$
DC current gain 1) $I_C = 5 \text{ mA}, V_{CE} = 5 \text{ V}$	$h_{FE}$	70	-	-	-
Collector-emitter saturation voltage1) $I_C = 10 \text{ mA}, I_B = 0.5 \text{ mA}$	$V_{CEsat}$	-	-	0.3	V
Input off voltage $I_C = 100 \mu\text{A}, V_{CE} = 5 \text{ V}$	$V_{i(off)}$	0.8	-	1.5	
Input on Voltage $I_C = 2 \text{ mA}, V_{CE} = 0.3 \text{ V}$	$V_{i(on)}$	1	-	3	
Input resistor	$R_1$	32	47	62	$\text{k}\Omega$
Resistor ratio	$R_1/R_2$	0.9	1	1.1	-
<b>AC Characteristics</b>					
Transition frequency $I_C = 10 \text{ mA}, V_{CE} = 5 \text{ V}, f = 100 \text{ MHz}$	$f_T$	-	100	-	MHz
Collector-base capacitance $V_{CB} = 10 \text{ V}, f = 1 \text{ MHz}$	$C_{cb}$	-	3	-	pF

 1) Pulse test:  $t < 300\mu\text{s}$ ;  $D < 2\%$

**DC Current Gain  $h_{FE} = f(I_C)$**

$V_{CE} = 5V$  (common emitter configuration)

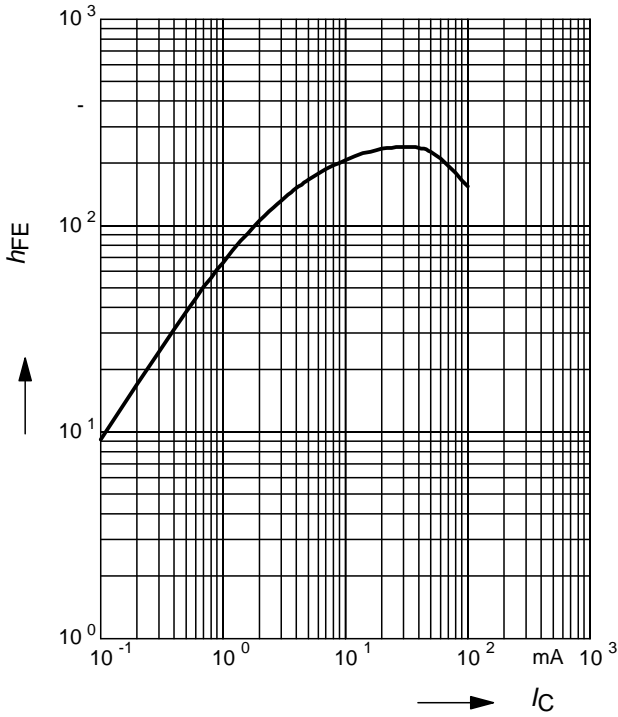

**Collector-Emitter Saturation Voltage**

$V_{CEsat} = f(I_C), h_{FE} = 20$

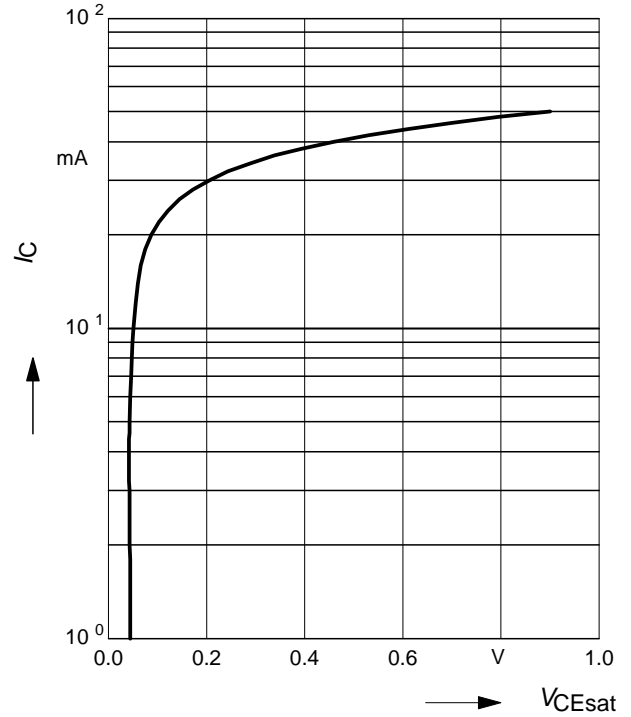

**Input on Voltage  $V_{i(on)} = f(I_C)$**

$V_{CE} = 0.3V$  (common emitter configuration)

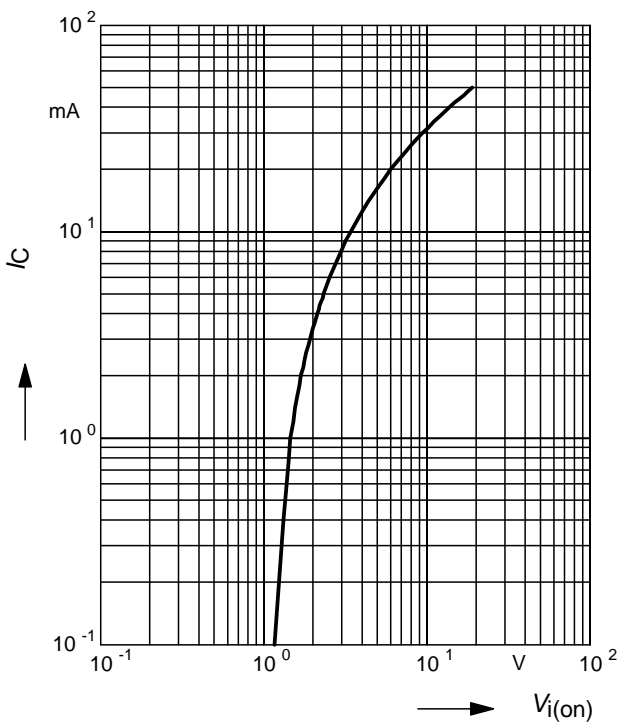

**Input off voltage  $V_{i(off)} = f(I_C)$**

$V_{CE} = 5V$  (common emitter configuration)

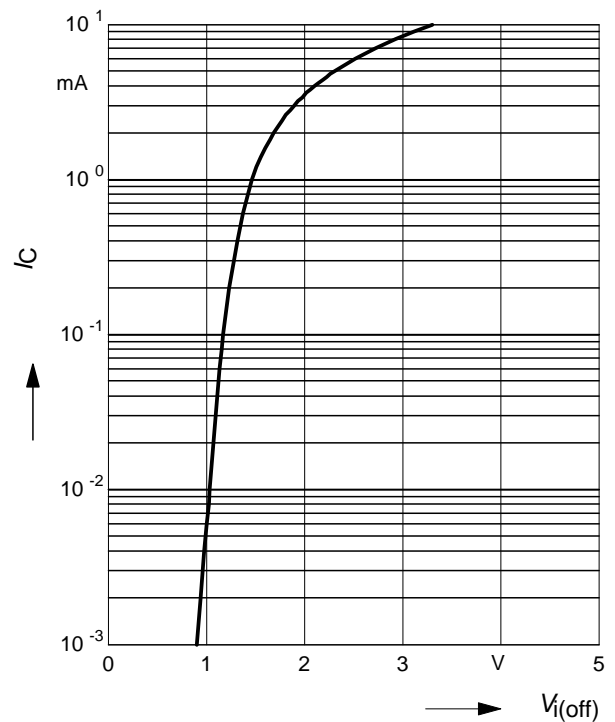

**Total power dissipation  $P_{tot} = f(T_S)$**

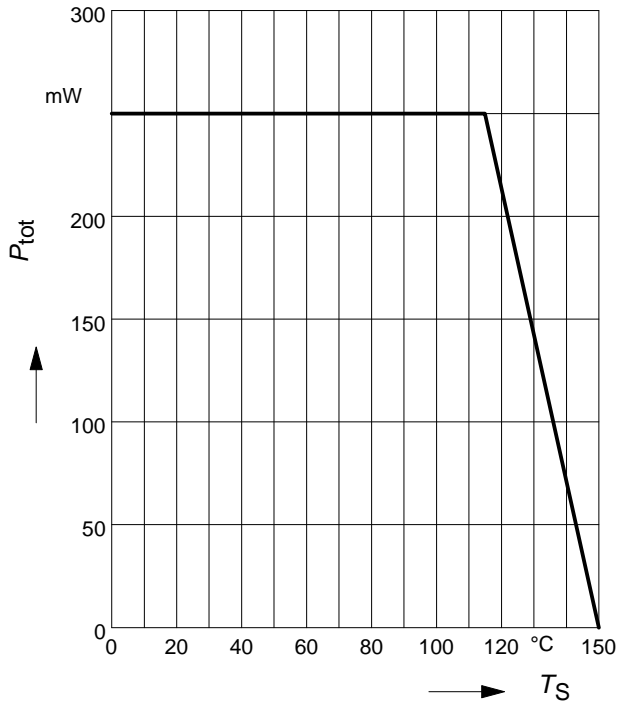

**Permissible Pulse Load  $R_{thJS} = f(t_p)$**

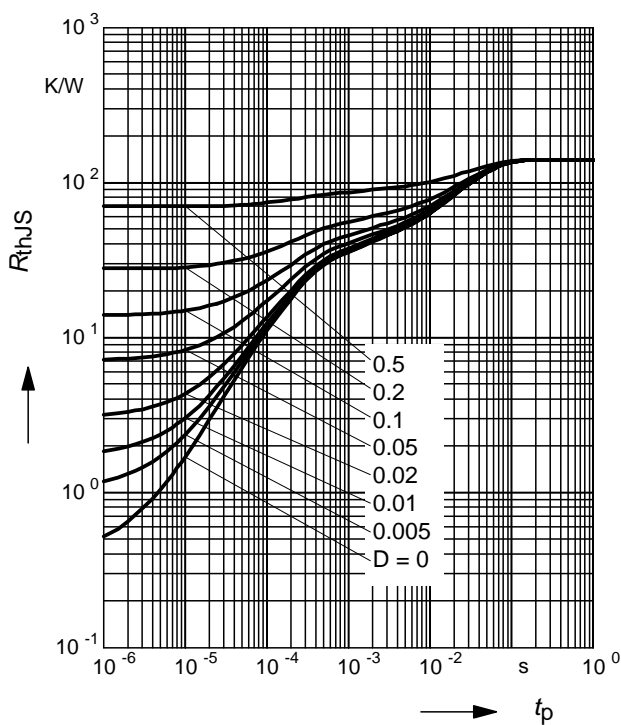

**Permissible Pulse Load**

$P_{totmax} / P_{totDC} = f(t_p)$

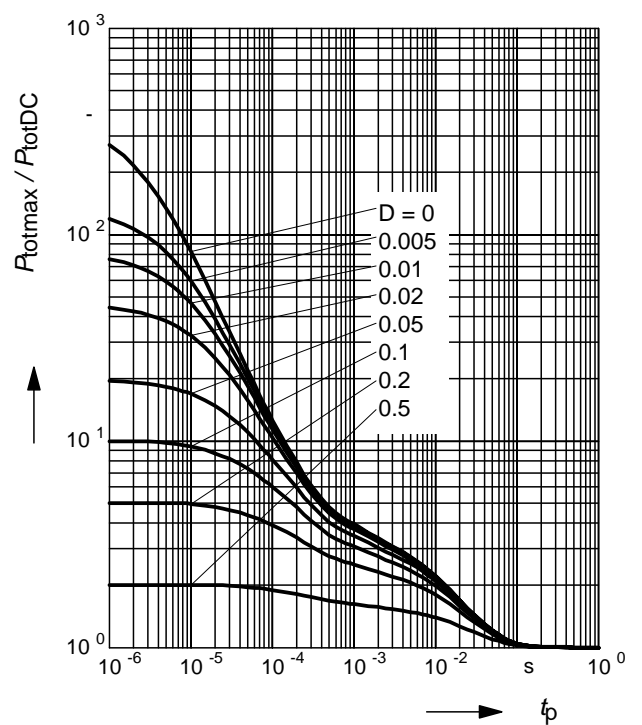

[www.s-manuals.com](http://www.s-manuals.com)