

NPN Silicon RF Transistor

- For highest gain low noise amplifier at 1.8 GHz and 2 mA / 2 V
Outstanding $G_{ms} = 23$ dB
Noise Figure $F = 0.95$ dB
- For oscillators up to 15 GHz
- Transition frequency $f_T = 45$ GHz
- Gold metallization for high reliability
- **SIEGET® 45 - Line**
45 GHz f_T - Line

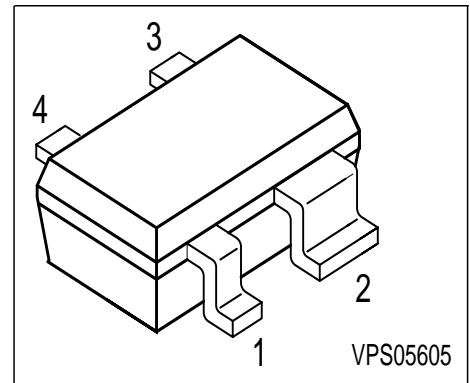

ESD: Electrostatic discharge sensitive device, observe handling precaution!

| Type | Marking | Pin Configuration | | | | Package |
|--------|---------|-------------------|-------|-------|-------|---------|
| BFP520 | APs | 1 = B | 2 = E | 3 = C | 4 = E | SOT343 |

Maximum Ratings

| Parameter | Symbol | Value | Unit |
|--|-----------|-------------|------|
| Collector-emitter voltage | V_{CEO} | 2.5 | V |
| Collector-base voltage | V_{CBO} | 10 | |
| Emitter-base voltage | V_{EBO} | 1 | |
| Collector current | I_C | 40 | mA |
| Base current | I_B | 4 | |
| Total power dissipation $T_S \leq 105$ °C ¹⁾ | P_{tot} | 100 | mW |
| Junction temperature | T_j | 150 | °C |
| Ambient temperature | T_A | -65 ... 150 | |
| Storage temperature | T_{stg} | -65 ... 150 | |

Thermal Resistance

| | | | |
|--|------------|------------|-----|
| Junction - soldering point ²⁾ | R_{thJS} | ≤ 450 | K/W |
|--|------------|------------|-----|

¹⁾ T_S is measured on the collector lead at the soldering point to the pcb

²⁾ For calculation of R_{thJA} please refer to Application Note Thermal Resistance

Electrical Characteristics at $T_A = 25^\circ\text{C}$, unless otherwise specified.

| Parameter | Symbol | Values | | | Unit |
|---|---------------|--------|------|------|---------------|
| | | min. | typ. | max. | |
| DC characteristics | | | | | |
| Collector-emitter breakdown voltage $I_C = 1 \text{ mA}, I_B = 0$ | $V_{(BR)CEO}$ | 2.5 | 3 | 3.5 | V |
| Collector-base cutoff current $V_{CB} = 5 \text{ V}, I_E = 0$ | I_{CBO} | - | - | 200 | nA |
| Emitter-base cutoff current $V_{EB} = 1 \text{ V}, I_C = 0$ | I_{EBO} | - | - | 35 | μA |
| DC current gain $I_C = 20 \text{ mA}, V_{CE} = 2 \text{ V}$ | h_{FE} | 70 | 110 | 200 | - |
| AC characteristics (verified by random sampling) | | | | | |
| Transition frequency $I_C = 30 \text{ mA}, V_{CE} = 2 \text{ V}, f = 2 \text{ GHz}$ | f_T | - | 45 | - | GHz |
| Collector-base capacitance $V_{CB} = 2 \text{ V}, f = 1 \text{ MHz}$ | C_{cb} | - | 0.06 | - | pF |
| Collector-emitter capacitance $V_{CE} = 2 \text{ V}, f = 1 \text{ MHz}$ | C_{ce} | - | 0.3 | - | |
| Emitter-base capacitance $V_{EB} = 0.5 \text{ V}, f = 1 \text{ MHz}$ | C_{eb} | - | 0.35 | - | |
| Noise figure $I_C = 2 \text{ mA}, V_{CE} = 2 \text{ V}, Z_S = Z_{Sopt}, f = 1.8 \text{ GHz}$ | F | - | 0.95 | - | dB |
| Power gain, maximum stable ¹⁾ $I_C = 20 \text{ mA}, V_{CE} = 2 \text{ V}, Z_S = Z_{Sopt}, Z_L = Z_{Lopt}, f = 1.8 \text{ GHz}$ | G_{ms} | - | 23 | - | |
| Insertion power gain $I_C = 20 \text{ mA}, V_{CE} = 2 \text{ V}, f = 1.8 \text{ GHz}, Z_S = Z_L = 50\Omega$ | $ S_{21} ^2$ | - | 21 | - | dBm |
| Third order intercept point at output $V_{CE} = 2 \text{ V}, f = 1.8 \text{ GHz}, Z_S = Z_{Sopt}, Z_L = Z_{Lopt}, I_C = 20 \text{ mA}$ $I_C = 7 \text{ mA}$ | IP_3 | - | 25 | - | |
| 1dB compression point $V_{CE} = 2 \text{ V}, f = 1.8 \text{ GHz}, Z_S = Z_{Sopt}, Z_L = Z_{Lopt}, I_C = 20 \text{ mA}$ $I_C = 7 \text{ mA}$ | P_{-1dB} | - | 12 | - | |
| | | - | 5 | - | |

$$^1G_{ms} = |S_{21} / S_{12}|$$

Common Emitter S-Parameters

| f | S ₁₁ | | S ₂₁ | | S ₁₂ | | S ₂₂ | |
|---|-----------------|--------|-----------------|-------|-----------------|------|-----------------|--------|
| | MAG | ANG | MAG | ANG | MAG | ANG | MAG | ANG |
| V _{CE} = 2 V, I _C = 20 mA | | | | | | | | |
| 0.01 | 0.7244 | -0.7 | 32.273 | 178.6 | 0.0007 | 69.4 | 0.9052 | 1.2 |
| 0.1 | 0.7251 | -8.4 | 31.637 | 171.4 | 0.0041 | 92.8 | 0.9363 | -4.4 |
| 0.5 | 0.6368 | -40.7 | 27.293 | 140.7 | 0.0194 | 75.9 | 0.8523 | -26.7 |
| 1 | 0.4768 | -73.6 | 19.601 | 113.5 | 0.0351 | 66.5 | 0.6496 | -46.1 |
| 2 | 0.2816 | -123.8 | 11.021 | 84.9 | 0.0057 | 56.3 | 0.3818 | -64.6 |
| 3 | 0.2251 | -166.1 | 7.481 | 67.6 | 0.0788 | 49.2 | 0.2407 | -73.6 |
| 4 | 0.2552 | 156.2 | 5.636 | 53.1 | 0.0994 | 41.5 | 0.1544 | -95.3 |
| 5 | 0.3207 | 133.6 | 4.488 | 39.7 | 0.1177 | 32.9 | 0.0951 | -128.9 |
| 6 | 0.3675 | 118.7 | 3.683 | 27.5 | 0.1343 | 24.7 | 0.0545 | 177.6 |

Common Emitter Noise Parameters

| f | F _{min} 1) | G _a 1) | Γ _{opt} | | R _N | r _n | F _{50Ω} 2) | S ₂₁ ² 2) |
|--|---------------------|-------------------|------------------|-----|----------------|----------------|---------------------|-----------------------------------|
| | dB | dB | MAG | ANG | Ω | - | dB | dB |
| V _{CE} = 2 V, I _C = 2 mA | | | | | | | | |
| 0.9 | 0.72 | 21.5 | 0.64 | 14 | 21.5 | 0.43 | 1.75 | 16.11 |
| 1.8 | 0.95 | 20.1 | 0.49 | 30 | 19.1 | 0.38 | 1.55 | 15.14 |
| 2.4 | 1.07 | 16.1 | 0.45 | 41 | 18.1 | 0.36 | 1.61 | 14.07 |
| 3 | 1.31 | 14.5 | 0.41 | 54 | 16.5 | 0.33 | 1.71 | 13.13 |
| 4 | 1.35 | 11.6 | 0.26 | 82 | 12.5 | 0.25 | 1.61 | 11.49 |
| 5 | 1.71 | 9.5 | 0.14 | 128 | 9.1 | 0.18 | 1.85 | 9.87 |
| 6 | 1.95 | 8.1 | 0.12 | 151 | 8.1 | 0.16 | 1.95 | 8.28 |

V_{CE} = 2 V, I_C = 5 mA

| | | | | | | | | |
|-----|------|------|------|-----|------|------|------|-------|
| 0.9 | 0.89 | 22.1 | 0.49 | 12 | 16.1 | 0.32 | 1.51 | 21.94 |
| 1.8 | 1.08 | 20.5 | 0.38 | 22 | 14.1 | 0.28 | 1.38 | 19.34 |
| 2.4 | 1.12 | 18.1 | 0.34 | 33 | 14.1 | 0.28 | 1.41 | 17.54 |
| 3 | 1.32 | 16.2 | 0.29 | 45 | 13.5 | 0.27 | 1.51 | 16.01 |
| 4 | 1.35 | 13.5 | 0.16 | 71 | 11.1 | 0.22 | 1.45 | 13.82 |
| 5 | 1.61 | 11.5 | 0.08 | 120 | 10.1 | 0.21 | 1.65 | 11.93 |
| 6 | 1.81 | 10.5 | 0.07 | 150 | 8.1 | 0.16 | 1.81 | 10.23 |

1) Input matched for minimum noise figure, output for maximum gain

2) Z_S = Z_L = 50Ω

For more and detailed S- and Noise-parameters please contact your local Infineon Technologies distributor or sales office to obtain a Infineon Technologies Application Notes CD-ROM or see Internet: <http://www.infineon.com/silicondiscretes>

SPICE Parameters (Gummel-Poon Model, Berkley-SPICE 2G.6 Syntax) :
Transistor Chip Data

| | | | | | | | | |
|-------|-------|----|-------|-------|-----|--------|-------|----|
| IS = | 15 | aA | BF = | 235 | - | NF = | 1 | - |
| VAF = | 25 | V | IKF = | 0.4 | A | ISE = | 25 | fA |
| NE = | 2 | - | BR = | 1.5 | - | NR = | 1 | - |
| VAR = | 2 | V | IKR = | 0.01 | A | ISC = | 20 | fA |
| NC = | 2 | - | RB = | 11 | Ω | IRB = | - | A |
| RBM = | 7.5 | Ω | RE = | 0.6 | | RC = | 7.6 | Ω |
| CJE = | 235 | fF | VJE = | 0.958 | V | MJE = | 0.335 | - |
| TF = | 1.7 | ps | XTF = | 10 | - | VTF = | 5 | V |
| ITF = | 0.7 | mA | PTF = | 50 | deg | CJC = | 93 | fF |
| VJC = | 0.661 | V | MJC = | 0.236 | - | XCJC = | 1 | - |
| TR = | 50 | ns | CJS = | 0 | fF | VJS = | 0.75 | V |
| MJS = | 0.333 | - | XTB = | -0.25 | - | EG = | 1.11 | eV |
| XTI = | 0.035 | - | FC = | 0.5 | - | TNOM | 298 | K |

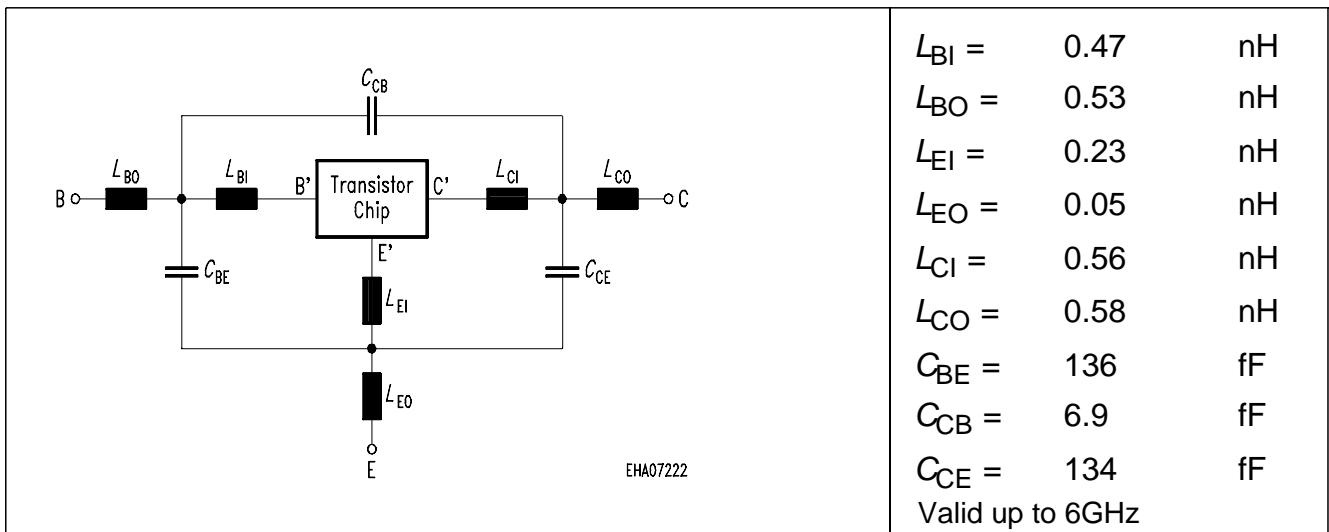
Package Equivalent Circuit:

The SOT-343 package has two emitter leads. To avoid high complexity of the package equivalent circuit, both leads are combined in one electrical connection.

For examples and ready to use parameters please contact your local Infineon Technologies distributor or sales office to obtain a Infineon Technologies CD-ROM or see Internet:
<http://www.infineon.com/silicondiscretes>

For non-linear simulation:

- Use transistor chip parameters in Berkeley SPICE 2G.6 syntax for all simulators.
- Simulation of the package is not necessary for frequencies < 100MHz.
For higher frequencies please add the wiring of the package equivalent circuit around the non-linear transistor.

Advantages of the common emitter configuration:

- Higher gain because of lower emitter inductance.
- Power is dissipated via the grounded emitter leads, because the chip is mounted on the copper emitter leadframe.

Please note, that the broadest lead is the emitter lead.

Total power dissipation $P_{tot} = f(T_S)$

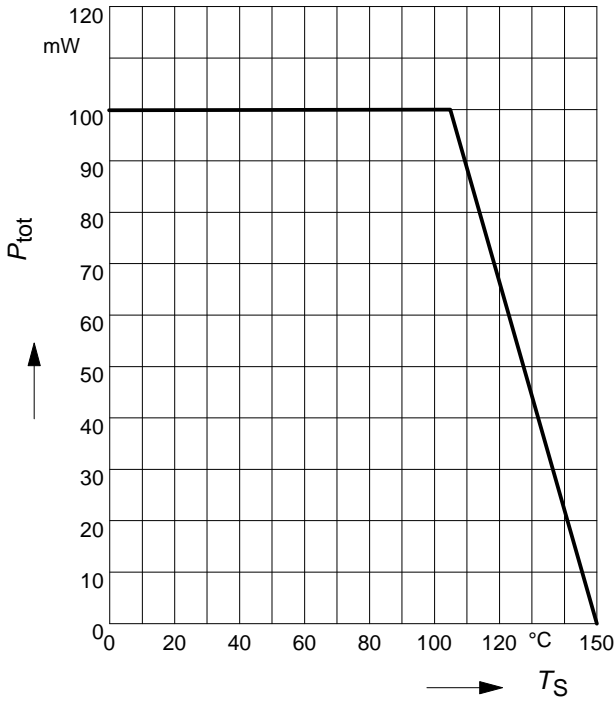

Transition frequency $f_T = f(I_C)$

$f = 2$ GHz

$V_{CE} =$ parameter in V

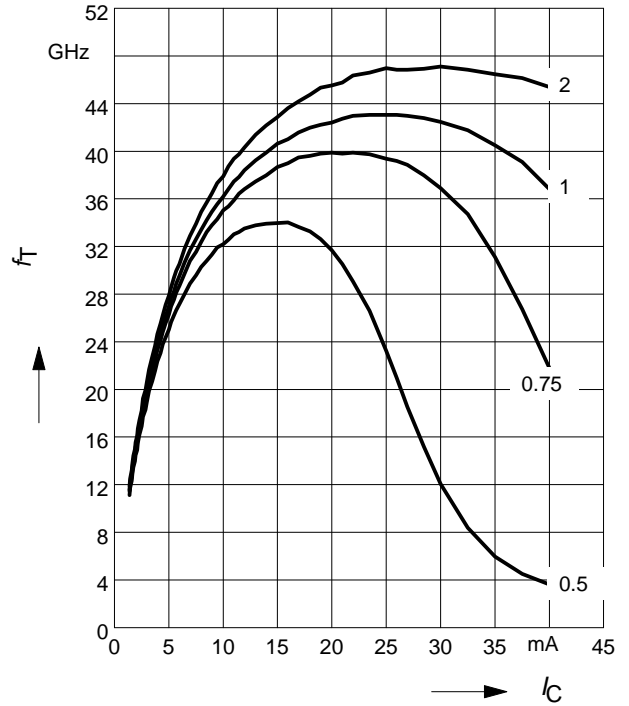

Permissible Pulse Load $R_{thJS} = f(t_p)$

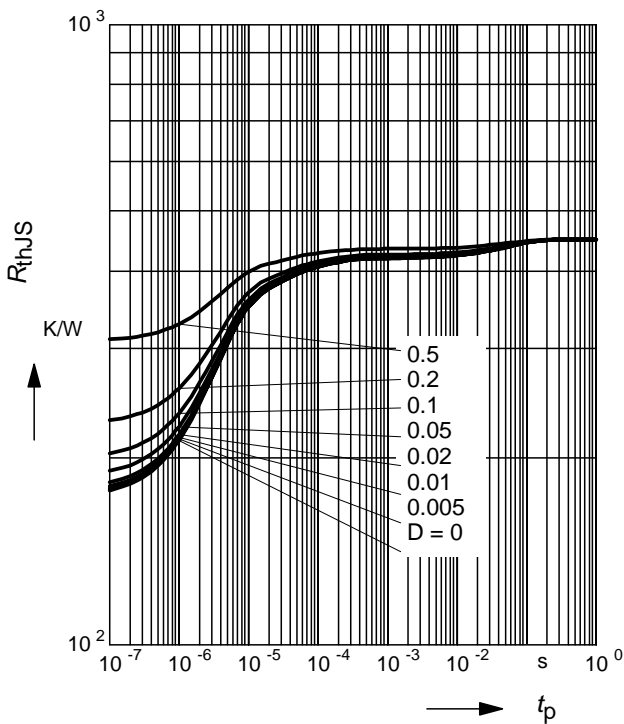

Permissible Pulse Load

$P_{totmax}/P_{totDC} = f(t_p)$

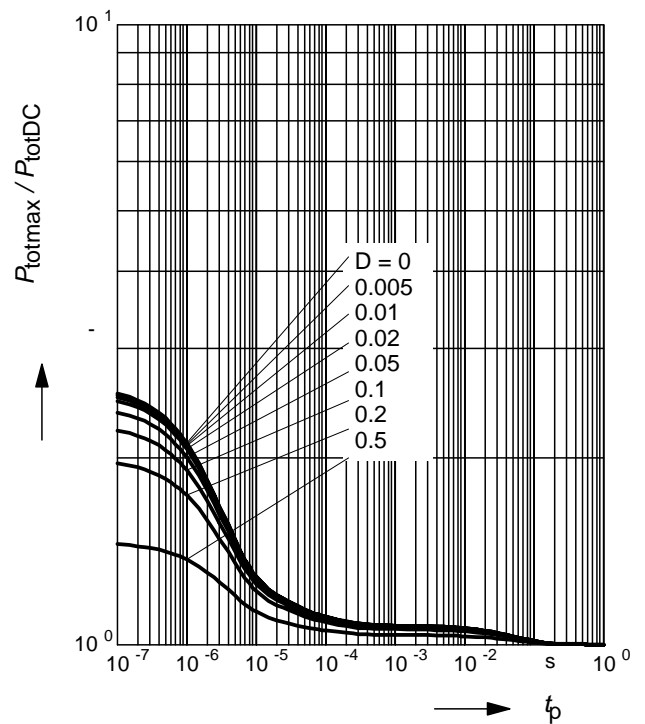

Power gain G_{ma} , G_{ms} , $|S_{21}|^2 = f(f)$

$V_{CE} = 2V$, $I_C = 20\text{ mA}$

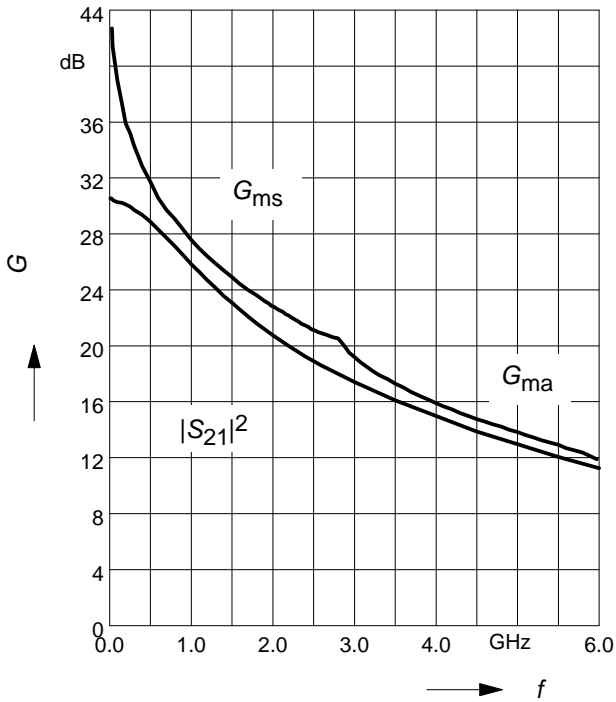

Power gain G_{ma} , $G_{ms} = f(I_C)$

$V_{CE} = 2V$

$f = \text{parameter in GHz}$

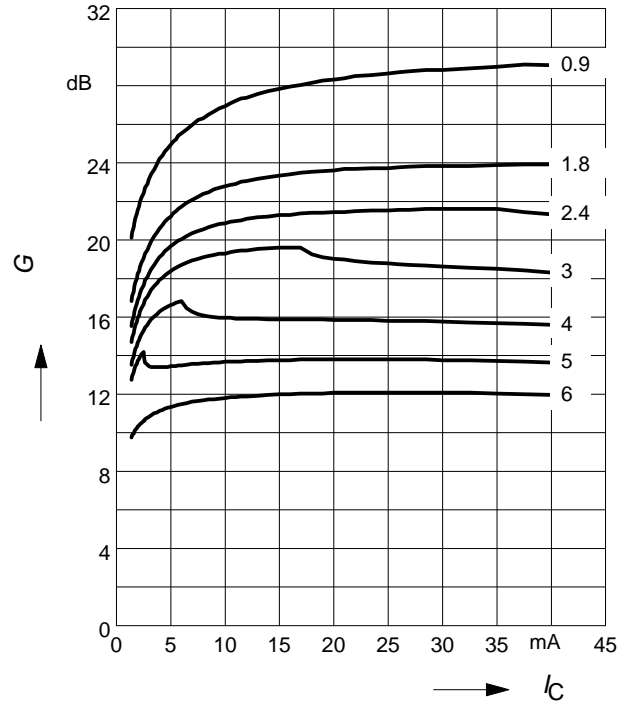

Power gain G_{ma} , $G_{ms} = f(V_{CE})$

$I_C = 20\text{ mA}$

$f = \text{parameter in GHz}$

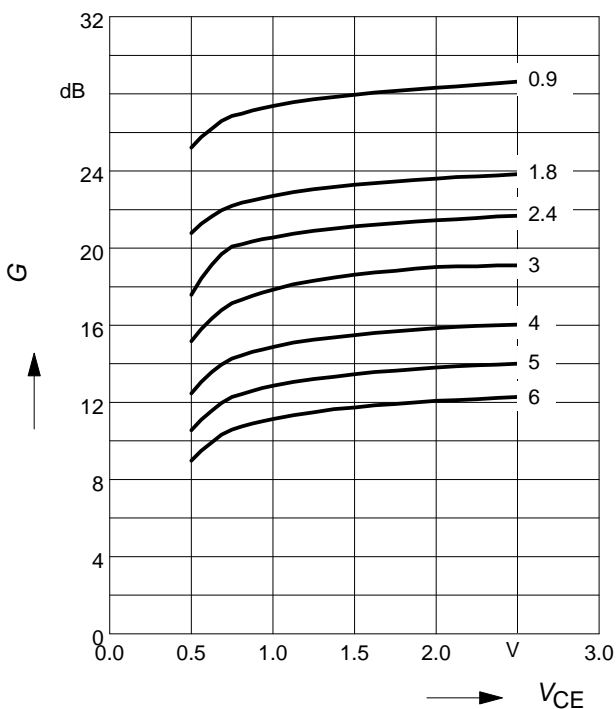

Collector-base capacitance $C_{cb} = f(V_{CB})$

$f = 1\text{ MHz}$

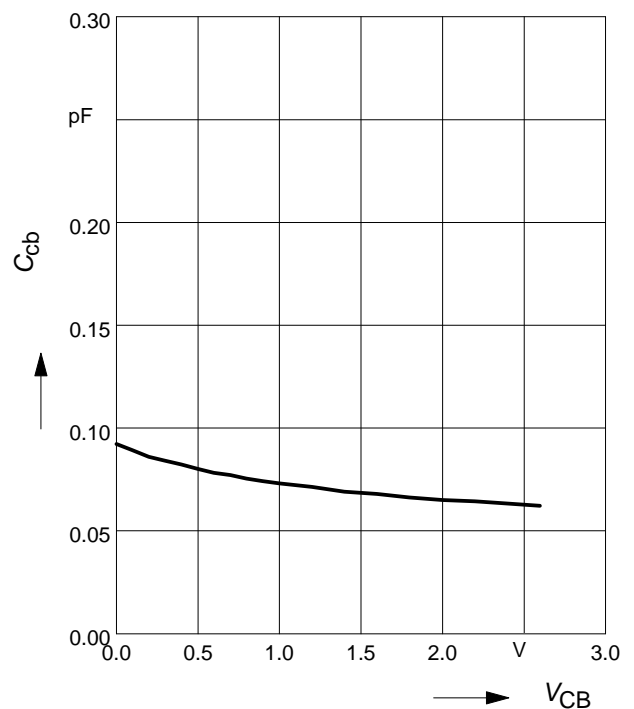

Noise figure $F = f(I_C)$

$V_{CE} = 2\text{ V}$, $Z_S = Z_{Sopt}$

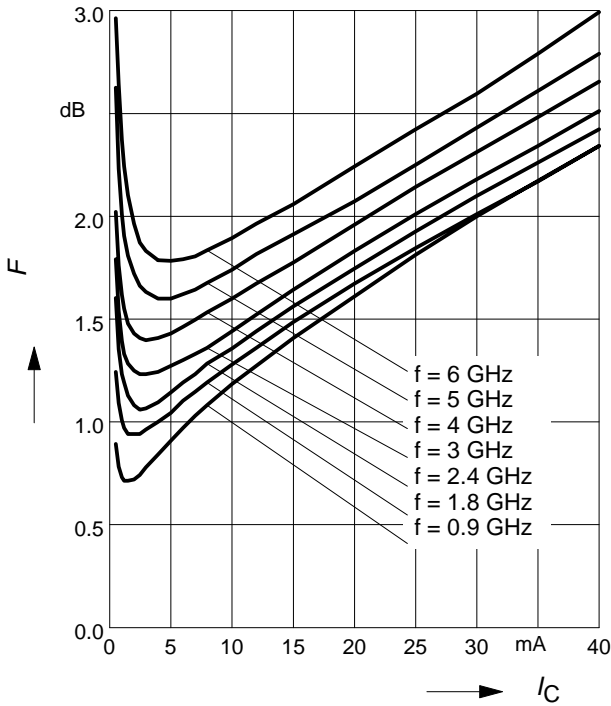

Noise figure $F = f(I_C)$

$V_{CE} = 2\text{ V}$, $f = 1.8\text{ GHz}$

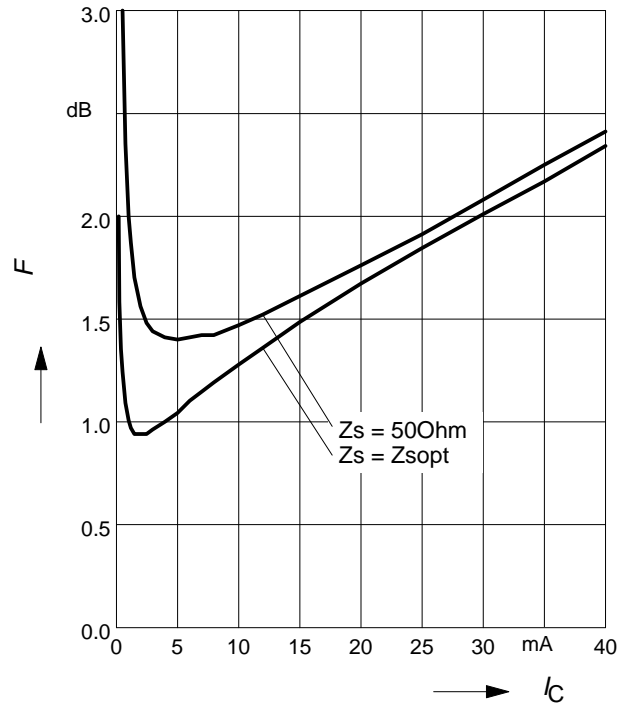

Noise figure $F = f(f)$

$V_{CE} = 2\text{ V}$, $Z_S = Z_{Sopt}$

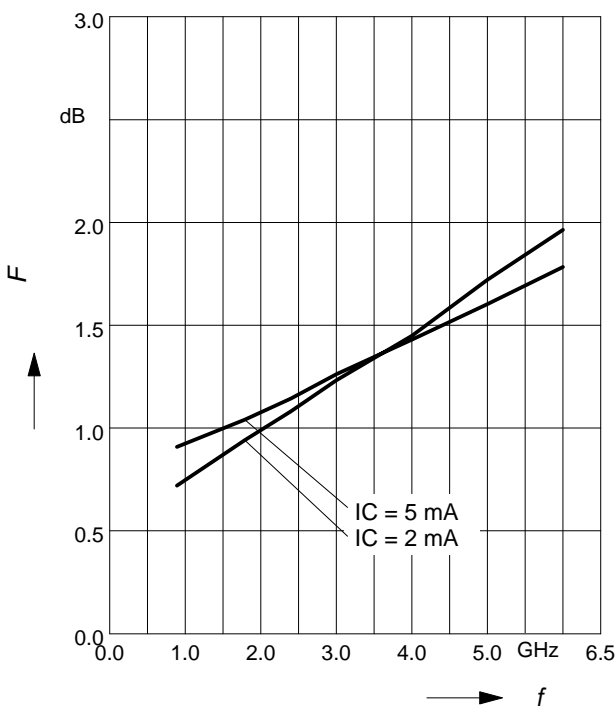

Source impedance for min. noise figure vs. Frequency

$V_{CE} = 2\text{ V}$, $I_C = 2\text{ mA} / 5\text{ mA}$

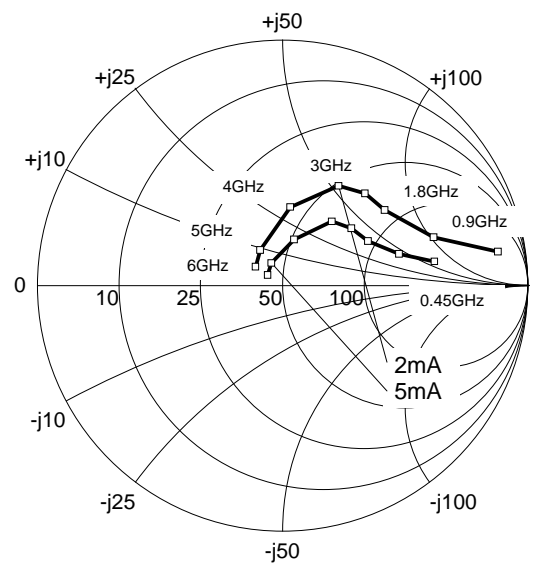

www.s-manuals.com