



**TO-251-3L/TO-252-2L Plastic-Encapsulate Regulators**

**CJ78M05** Three-terminal positive voltage regulator

**FEATURES**

- Maximum output current  
I<sub>OM</sub>: 0.5 A
- Output voltage  
V<sub>O</sub>: 5V
- Continuous total dissipation  
P<sub>D</sub>: 1.25 W

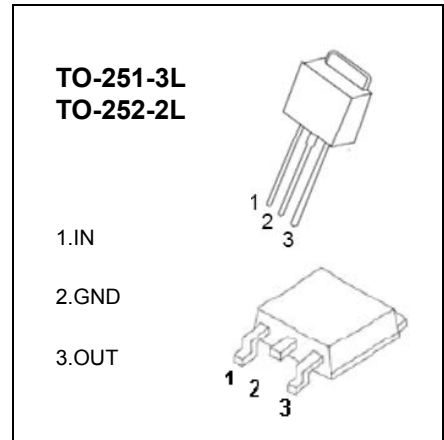

**ABSOLUTE MAXIMUM RATINGS (Operating temperature range applies unless otherwise specified)**

Parameter	Symbol	Value	Unit
Input Voltage	V <sub>i</sub>	25	V
Operating Junction Temperature Range	T <sub>OPR</sub>	0-+125	°C
Storage Temperature Range	T <sub>STG</sub>	-65-+150	°C

ELECTRICAL CHARACTERISTICS AT SPECIFIED VIRTUAL JUNCTION TEMPERATURE (V<sub>i</sub>=10V, I<sub>o</sub>=350mA, C<sub>i</sub>=0.33μF, C<sub>o</sub>=0.1μF, unless otherwise specified)

Parameter	Symbol	Test conditions	Min	Typ	Max	Unit
Output Voltage	V <sub>o</sub>	25°C	4.8	5	5.2	V
		7V ≤ V <sub>i</sub> ≤ 20V, I <sub>o</sub> = 5mA-350mA P <sub>o</sub> ≤ 15W	0-125°C	4.75	5	5.25
Load Regulation	ΔV <sub>o</sub>	I <sub>o</sub> = 5mA-0.5A	25°C	15	100	mV
		I <sub>o</sub> = 5mA-200mA	25°C	5	50	mV
Line Regulation	ΔV <sub>o</sub>	7V ≤ V <sub>i</sub> ≤ 25V, I <sub>o</sub> = 200mA	25°C	3	100	mV
		8V ≤ V <sub>i</sub> ≤ 25V, I <sub>o</sub> = 200mA	25°C	1	50	mV
Quiescent Current	I <sub>q</sub>	25°C		4.2	6	mA
Quiescent Current Change	ΔI <sub>q</sub>	8V ≤ V <sub>i</sub> ≤ 25V, I <sub>o</sub> = 200mA	0-125°C		0.8	mA
		5mA ≤ I <sub>o</sub> ≤ 350mA	0-125°C		0.5	mA
Output Noise Voltage	V <sub>N</sub>	10Hz ≤ f ≤ 100KHz	25°C	40	200	μV
Ripple Rejection	RR	8V ≤ V <sub>i</sub> ≤ 18V, f = 120Hz, I <sub>o</sub> = 300mA	0-125°C	62	80	dB
Dropout Voltage	V <sub>d</sub>	I <sub>o</sub> = 350mA	25°C	2	2.5	V
Short Circuit Current	I <sub>sc</sub>	V <sub>i</sub> = 10V	25°C	300		mA
Peak Current	I <sub>pk</sub>		25°C	0.5		A

**TYPICAL APPLICATION**

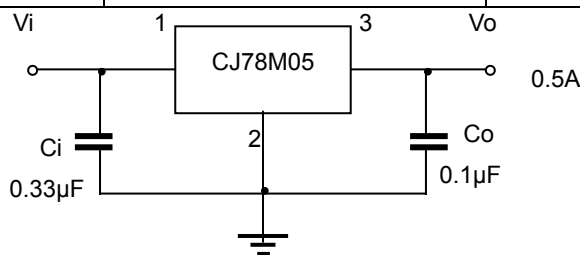

# Typical Characteristics

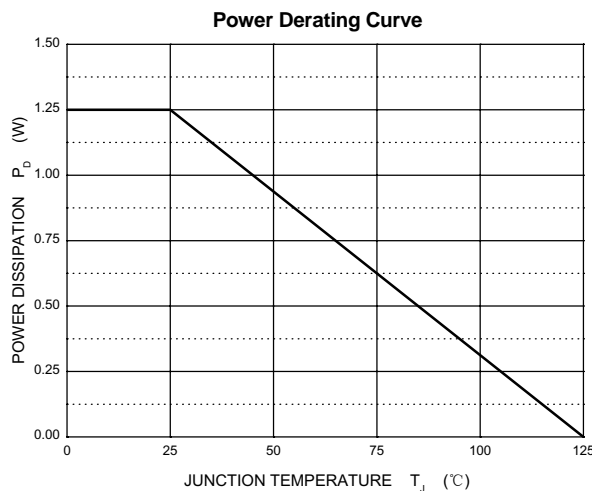
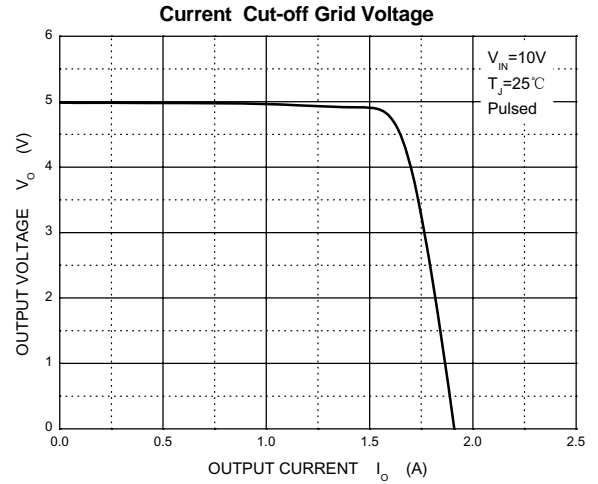
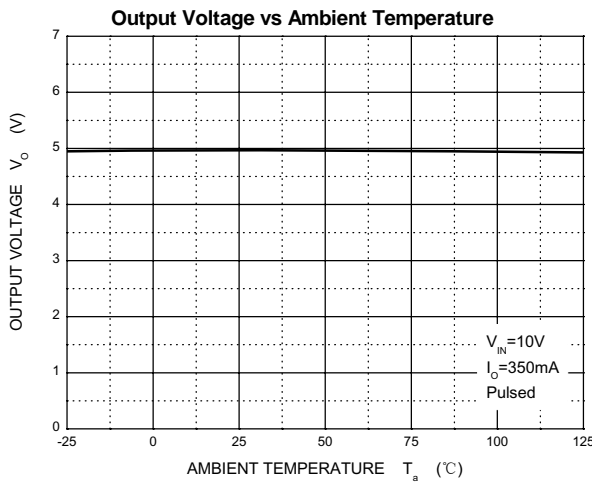
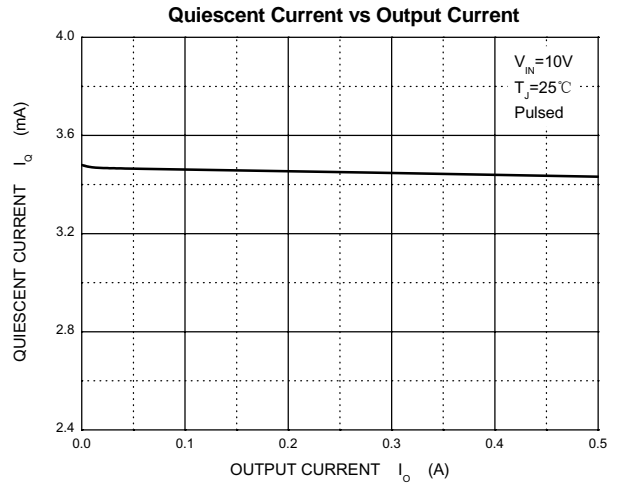
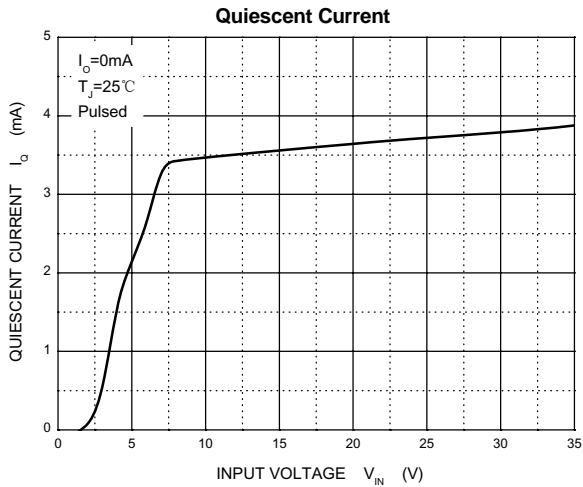
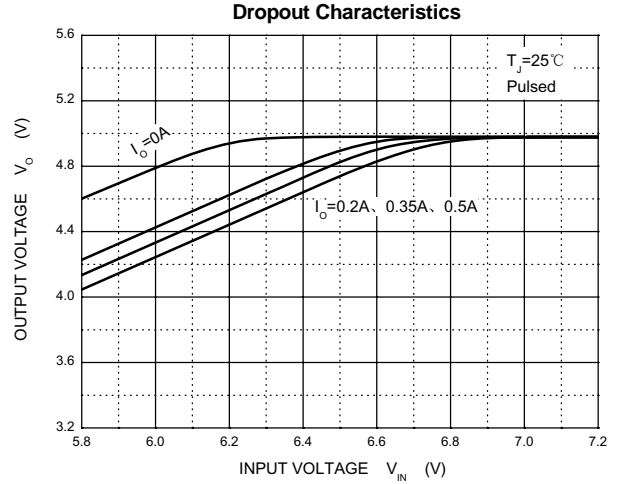
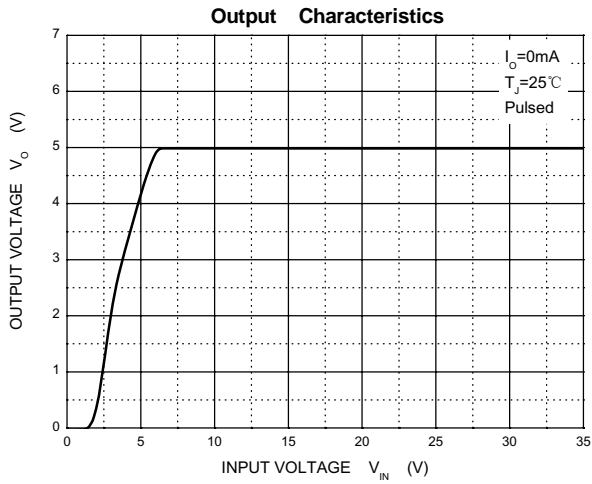

## TO-252(4R)-2L Package Outline Dimensions

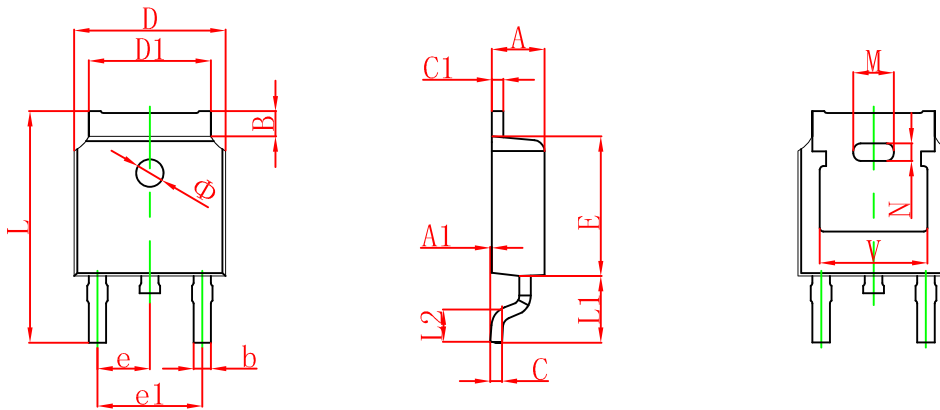

Symbol	Dimensions In Millimeters		Dimensions In Inches	
	Min.	Max.	Min.	Max.
A	2.200	2.380	0.087	0.094
A1	0.000	0.100	0.000	0.004
B	0.800	1.400	0.031	0.055
b	0.710	0.810	0.028	0.032
c	0.460	0.560	0.018	0.022
c1	0.460	0.560	0.018	0.022
D	6.500	6.700	0.256	0.264
D1	5.130	5.460	0.202	0.215
E	6.000	6.200	0.236	0.244
e	2.286 TYP.		0.090 TYP.	
e1	4.327	4.727	0.170	0.186
M	1.778REF.		0.070REF.	
N	0.762REF.		0.018REF.	
L	9.800	10.400	0.386	0.409
L1	2.9REF.		0.114REF.	
L2	1.400	1.700	0.055	0.067
V	4.830 REF.		0.190 REF.	
Φ	1.100	1.300	0.043	0.051

## TO-252(4R)-2L Suggested Pad Layout

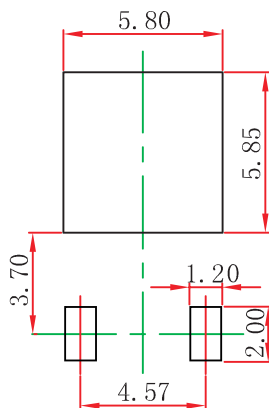

### Note:

1. Controlling dimension: in millimeters.
2. General tolerance:  $\pm 0.05\text{mm}$ .
3. The pad layout is for reference purposes only.

### NOTICE

JCET reserve the right to make modifications, enhancements, improvements, corrections or other changes without further notice to any product herein. JCET does not assume any liability arising out of the application or use of any product described herein.

## TO-252 Tape and reel

### TO-252 Embossed Carrier Tape

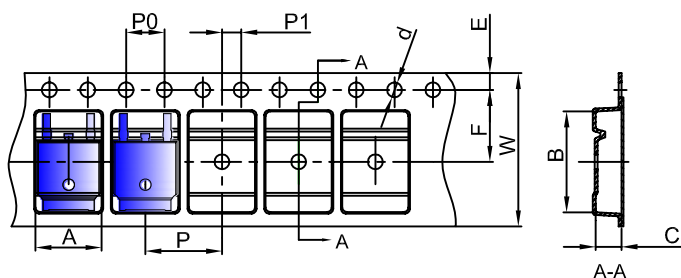

#### Packaging Description:

TO-252 parts are shipped in tape. The carrier tape is made from a dissipative (carbon filled) polycarbonate resin. The cover tape is a multilayer film (Heat Activated Adhesive in nature) primarily composed of polyester film, adhesive layer, sealant, and anti-static sprayed agent. These reeled parts in standard option are shipped with 25,00 units per 13" or 33.0 cm diameter reel. The reels are clear in color and is made of polystyrene plastic (anti-static coated).

Dimensions are in millimeter										
Pkg type	A	B	C	d	E	F	P0	P	P1	W
TO-252	6.90	10.50	2.70	Ø1.55	1.75	7.50	4.00	8.00	2.00	16.00
(Tolerance)	+/-0.1	+/-0.1	+/-0.1	+/-0.1	+/-0.1	+/-0.1	+/-0.1	+/-0.1	+/-0.1	+0.3/-0.1

### TO-252 Tape Leader and Trailer

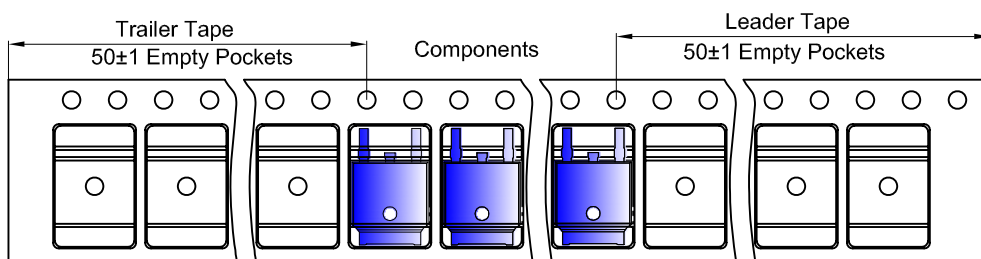

### TO-252 Reel

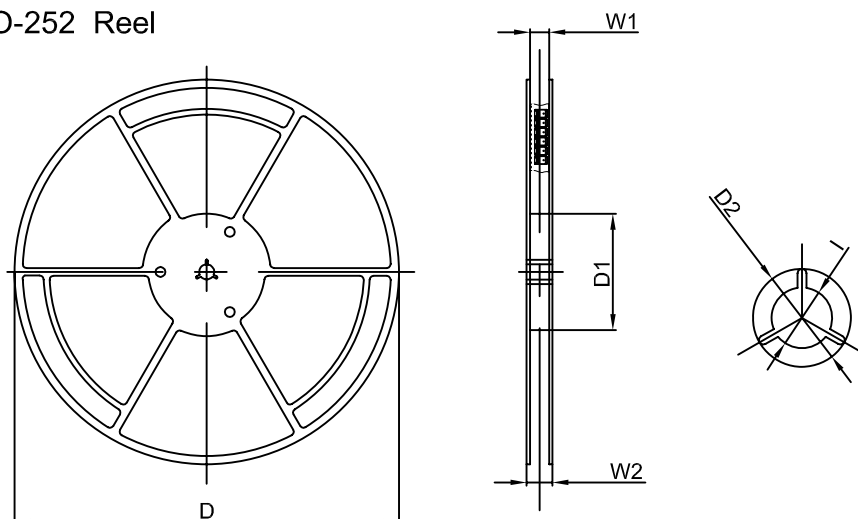

Dimensions are in millimeter						
Reel Option	D	D1	D2	W1	W2	I
13"Dia	330.00	100.00	Ø21.00	16.40	21.00	Ø13.00
Tolerance	+/-2	+/-1	+/-1	+/-1	+/-1	+/-1

REEL	Reel Size	Box	Box Size(mm)	Carton	Carton Size(mm)	G.W.(kg)
2,500 pcs	13inch	2,500 pcs	340×336×29	25,000 pcs	353×346×365	14.04

[www.s-manuals.com](http://www.s-manuals.com)