

2 Channel Headset Microphone EMI Filter with ESD Protection

Features

- Two channels of EMI filtering
- Pi-style EMI filters in a capacitor-resistor-capacitor (C-R-C) network
- Greater than 40dB attenuation at 1GHz
- $\pm 8\text{kV}$ ESD protection on each channel (IEC 61000-4-2 Level 4, contact discharge)
- $\pm 15\text{kV}$ ESD protection on each channel (HBM)
- Supports bipolar signals—ideal for audio applications
- Chip Scale Package features extremely low lead inductance for optimum filter and ESD performance
- 5-bump, 0.950mm X 1.410mm footprint Chip Scale Package (CSP)
- Lead-free version available

Applications

- EMI filtering and ESD protection for headset microphone ports
- Wireless Handsets
- Handheld PCs / PDAs
- MP3 Players
- Digital Camcorders
- Notebooks
- Desktop PCs

Product Description

The CSPEMI202A is a dual low-pass filter array integrating two pi-style filters (C-R-C) that reduce EMI/RFI emissions while at the same time providing ESD protection. This part is custom-designed to interface with a microphone port on a cellular telephone or similar device. Each high quality filter provides more than 35dB attenuation in the 800-2700 MHz range. These pi-style filters support bidirectional filtering, controlling EMI both to and from a microphone element. They also support bipolar signals, enabling audio signals to pass through without distortion.

In addition, the CSPEMI202A provides a very high level of protection for sensitive electronic components that may be subjected to electrostatic discharge (ESD). The input pins are designed and characterized to safely dissipate ESD strikes of 8kV, the maximum requirement of the IEC 61000-4-2 international standard. Using the MIL-STD-883 (Method 3015) specification for Human Body Model (HBM) ESD, the device provides protection for contact discharges to greater than 15kV.

The CSPEMI202A is particularly well suited for portable electronics (e.g., cellular telephones, PDAs, notebook computers) because of its small package format and low weight. The CSPEMI202A is available in a space-saving, low-profile Chip Scale Package with optional lead-free finishing.

Electrical Schematic

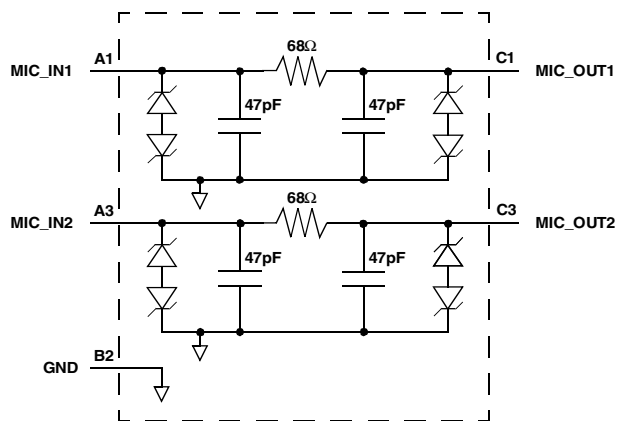



PACKAGE / PINOUT DIAGRAMS

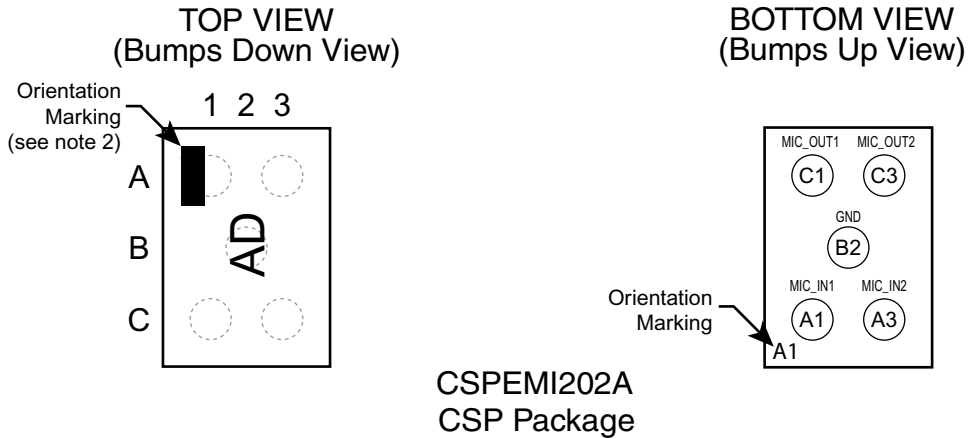

Note:

- 1) These drawings are not to scale.
- 2) Lead-free devices are specified by using a "+" character for the top side orientation mark.

PIN DESCRIPTIONS

PIN	NAME	DESCRIPTION
A1	MIC_IN1	Microphone Input 1 (from microphone)
A3	MIC_IN2	Microphone Input 2 (from microphone)
B2	GND	Device Ground
C1	MIC_OUT1	Microphone Output 1 (to audio circuitry)
C3	MIC_OUT2	Microphone Output 2 (to audio circuitry)

Ordering Information

PART NUMBERING INFORMATION

Bumps	Package	Standard Finish		Lead-free Finish ²	
		Ordering Part Number ¹	Part Marking	Ordering Part Number ¹	Part Marking
5	CSP	CSPEMI202A	AD	CSPEMI202AG	AD

Note 1: Parts are shipped in Tape & Reel form unless otherwise specified.

Note 2: Lead-free devices are specified by using a "+" character for the top side orientation mark.

Specifications

ABSOLUTE MAXIMUM RATINGS

PARAMETER	RATING	UNITS
Storage Temperature Range	-65 to +150	°C
DC Power per Resistor	100	mW
DC Package Power Rating	200	mW

STANDARD OPERATING CONDITIONS

PARAMETER	RATING	UNITS
Operating Temperature Range	-40 to +85	°C

ELECTRICAL OPERATING CHARACTERISTICS¹

SYMBOL	PARAMETER	CONDITIONS	MIN	TYP	MAX	UNITS
R ₁	Resistance		61	68	75	Ω
C ₁	Capacitance		38	47	56	pF
I _{LEAK}	Diode Leakage Current	V _{IN} =5.0V			1.0	μA
V _{SIG}	Signal Voltage Positive Clamp Negative Clamp	I _{LOAD} = 10mA	5 -5	7 -10	15 -15	V V
V _{ESD}	In-system ESD Withstand Voltage a) Human Body Model, MIL-STD-883, Method 3015 b) Contact Discharge per IEC 61000-4-2 Level 4	Notes 2,4 and 5	±15 ±8			kV kV
V _{CL}	Clamping Voltage during ESD Discharge MIL-STD-883 (Method 3015), 8kV Positive Transients Negative Transients	Notes 2,3,4 and 5		+15 -19		V V
f _C	Cut-off frequency Z _{SOURCE} = 50Ω, Z _{LOAD} = 50Ω	R = 68Ω, C = 47pF		60		MHz

Note 1: T_A=25°C unless otherwise specified.

Note 2: ESD applied to input and output pins with respect to GND, one at a time.

Note 3: Clamping voltage is measured at the opposite side of the EMI filter to the ESD pin. For example, if ESD is applied to Pin A1, then clamping voltage is measured at Pin C1.

Note 4: Unused pins are left open

Note 5: These parameters are guaranteed by design and characterization.

Performance Information

Typical Filter Performance (nominal conditions unless specified otherwise, 50 Ohm Environment)

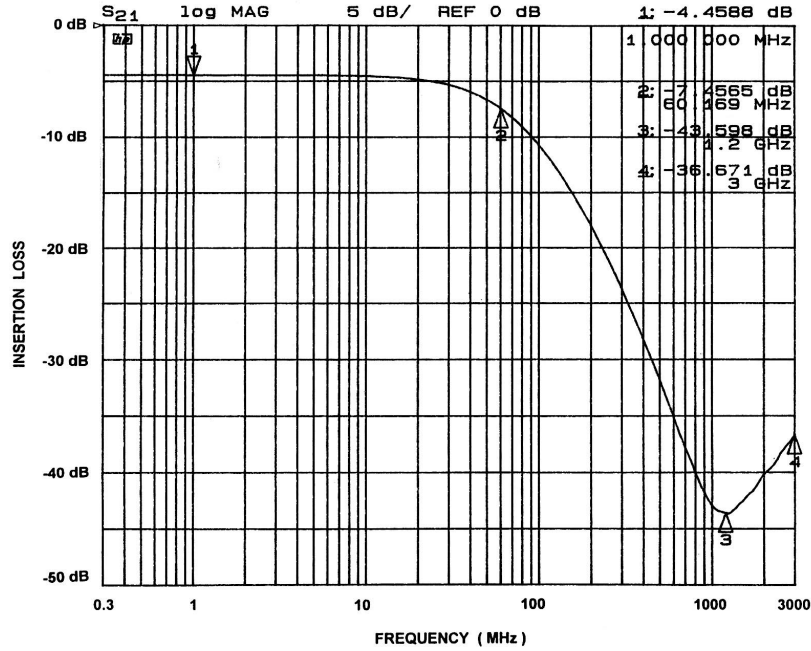

Figure 1. Insertion Loss VS. Frequency (A1-C1 to GND B2)

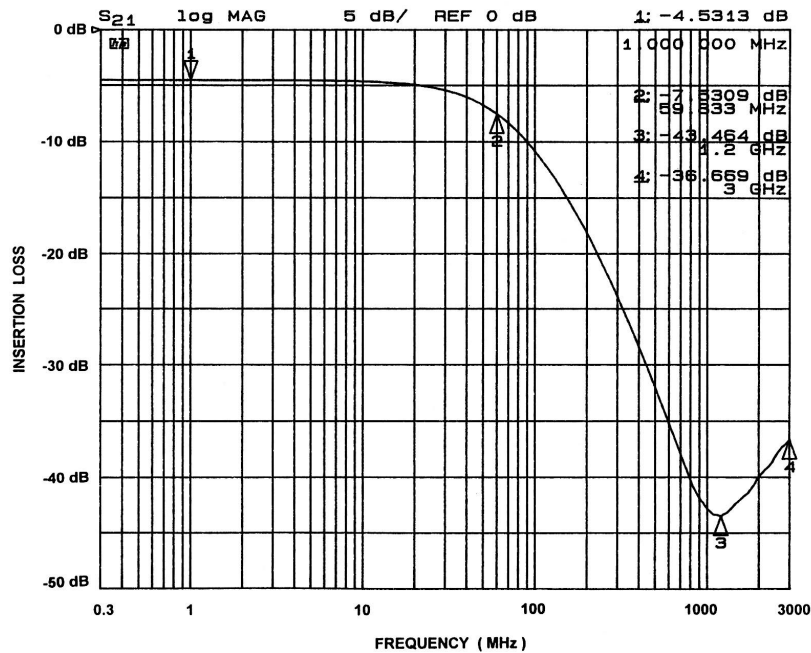

Figure 2. Insertion Loss VS. Frequency (A3-C3 to GND B2)

Application Information

Refer to Application Note AP-217, "The Chip Scale Package", for a detailed description of Chip Scale Packages offered by California Micro Devices.

PRINTED CIRCUIT BOARD RECOMMENDATIONS	
PARAMETER	VALUE
Pad Size on PCB	0.275mm
Pad Shape	Round
Pad Definition	Non-Solder Mask defined pads
Solder Mask Opening	0.325mm Round
Solder Stencil Thickness	0.125 - 0.150mm
Solder Stencil Aperture Opening (laser cut, 5% tapered walls)	0.330mm Round
Solder Flux Ratio	50/50 by volume
Solder Paste Type	No Clean
Pad Protective Finish	OSP (Entek Cu Plus 106A)
Tolerance — Edge To Corner Ball	±50µm
Solder Ball Side Coplanarity	±20µm
Maximum Dwell Time Above Liquidous	60 seconds
Soldering Maximum Temperature	260°C

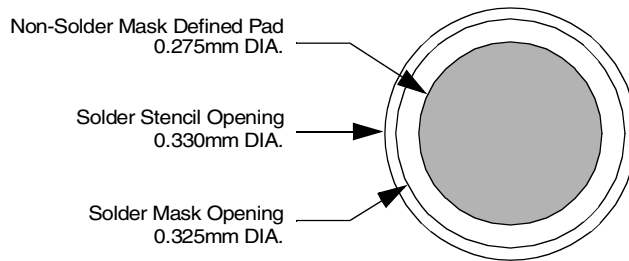

Figure 3. Recommended Non-Solder Mask Defined Pad Illustration

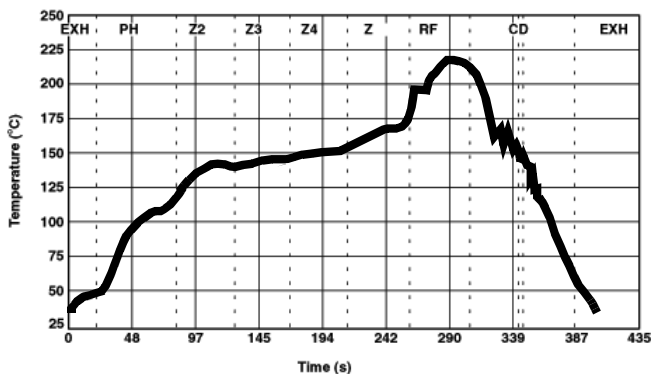

Figure 4. Eutectic (SnPb) Solder Ball Reflow Profile

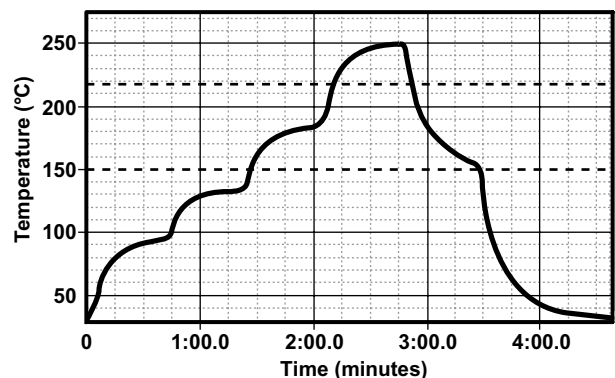

Figure 5. Lead-free (SnAgCu) Solder Ball Reflow Profile

Mechanical Details

CSP Mechanical Specifications

CSPEMI202A devices are packaged in a custom Chip Scale Package (CSP). Dimensions are presented below. For complete information on CSP packaging, see the California Micro Devices CSP Package Information document.

PACKAGE DIMENSIONS						
Package	Custom CSP					
Bumps	5					
Dim	Millimeters			Inches		
	Min	Nom	Max	Min	Nom	Max
A1	0.905	0.950	0.995	0.0356	0.0374	0.0392
A2	1.365	1.410	1.455	0.0537	0.0555	0.0573
B1	0.495	0.500	0.505	0.0195	0.0197	0.0199
B2	0.245	0.250	0.255	0.0096	0.0098	0.0100
B3	0.430	0.435	0.440	0.0169	0.0171	0.0173
B4	0.430	0.435	0.440	0.0169	0.0171	0.0173
C1	0.175	0.225	0.275	0.0069	0.0089	0.0108
C2	0.220	0.270	0.320	0.0087	0.0106	0.0126
D1	0.561	0.605	0.649	0.0221	0.0238	0.0255
D2	0.355	0.380	0.405	0.0140	0.0150	0.0159
# per tape and reel	3500 pieces					
Controlling dimension: millimeters						

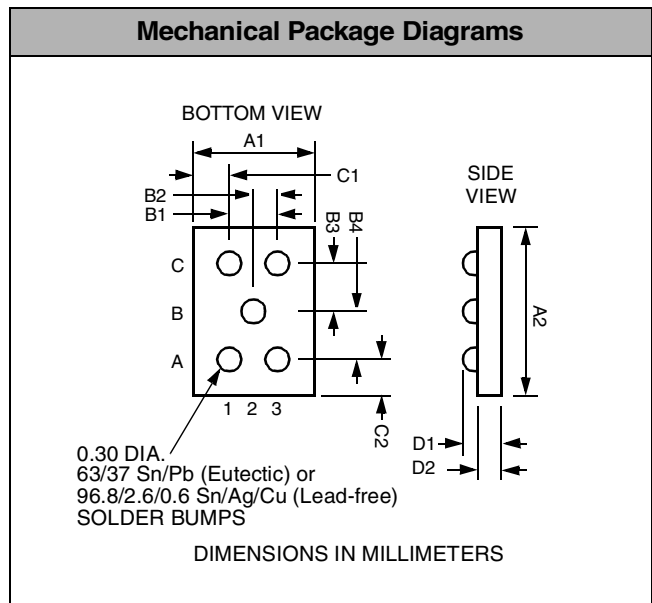

Package Dimensions for CSPEMI202A Chip Scale Package

CSP Tape and Reel Specifications

PART NUMBER	CHIP SIZE (mm)	POCKET SIZE (mm) B ₀ X A ₀ X K ₀	TAPE WIDTH W	REEL DIAMETER	QTY PER REEL	P ₀	P ₁
CSPEMI202A	1.41 X 0.95 X 0.6	1.52 X 1.07 X 0.72	8mm	178mm (7")	3500	4mm	4mm

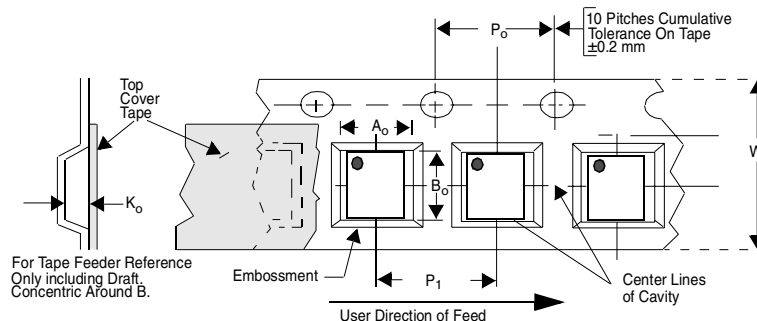

Figure 6. Tape and Reel Mechanical Data