



DAN202

100 mA Switching Diode 80 Volts

Features

- High reliability
- High speed (Trr=1.5ns Typ.)
- Lead Free Finish/RoHS Compliant ("P" Suffix designates RoHS Compliant. See ordering information)
- Epoxy meets UL 94 V-0 flammability rating
- Moisture Sensitivity Level 1
- Halogen free available upon request by adding suffix "-HF"

Maximum Ratings

Symbol	Parameter	Rating	Unit
V _{RM}	Peak Reverse Voltage	80	V
I _o	Average Forward Current	100	mA
I _{FM}	Peak Forward Current	300	mA
P _D	Power dissipation	200	mW
T _J	Junction Temperature	-55 to +150	°C
T _{STG}	Storage Temperature	-55 to +150	°C

Electrical Characteristics @ 25°C Unless Otherwise Specified

Symbol	Parameter	Min	Typ	Max	Units
OFF CHARACTERISTICS					
V _F	Forward Voltage (I _F =100mA)	---	---	1.2	Vdc
I _R	Reverse Current (V _R =70Vdc)	---	---	0.1	uA
C _D	Diode Capacitance (V _R =6V, f=1MHz)	---	---	3.5	pF
t _{rr}	Reverse Recovery Time (V _R =6V, I _F =5mA)	---	---	4	ns

Marking: N

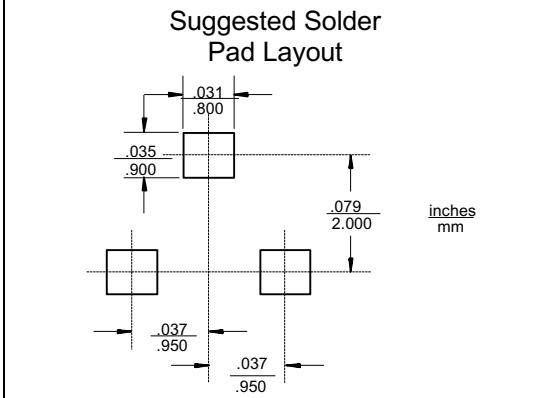
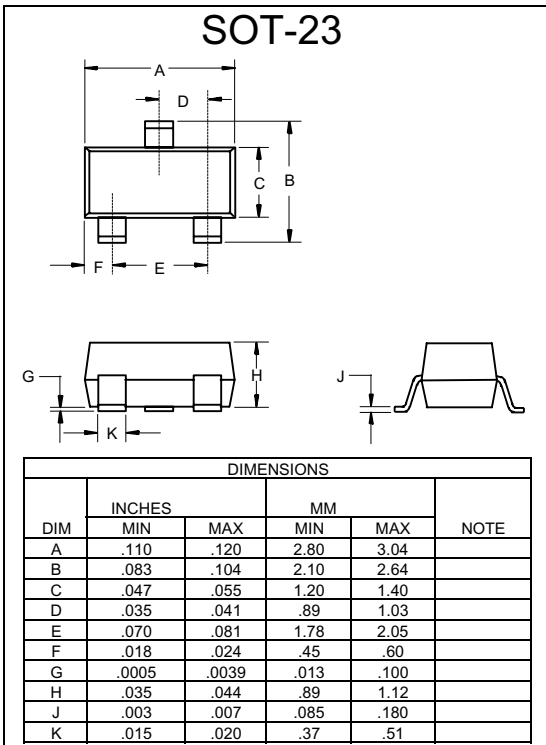
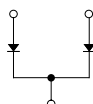

DAN202



Micro Commercial Components

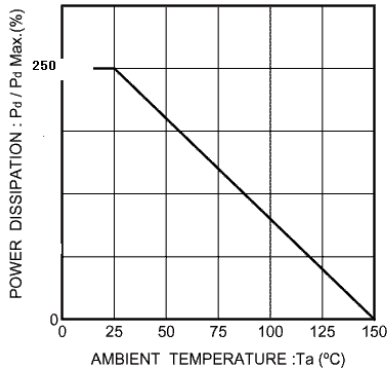

Power attenuation curve

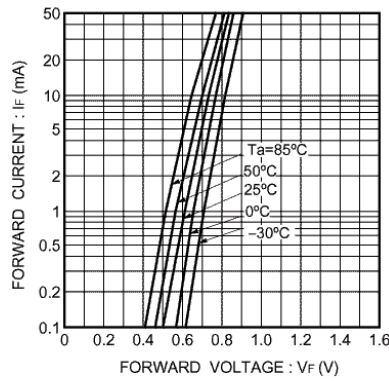

Forward characteristics (P Type)

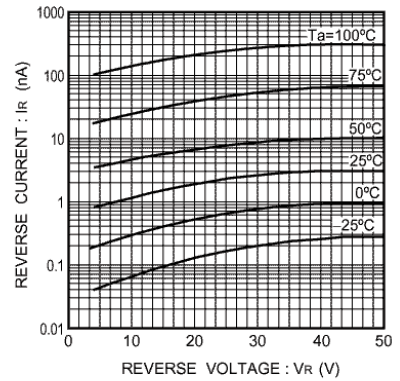

Reverse characteristics (P Type)

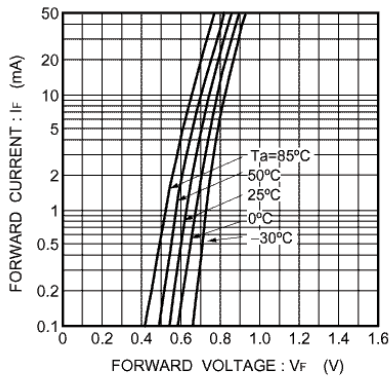

Forward characteristics (N Type)

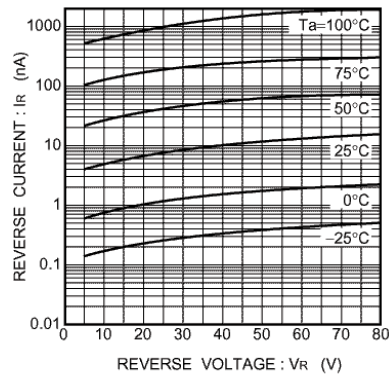

Reverse characteristics (N Type)

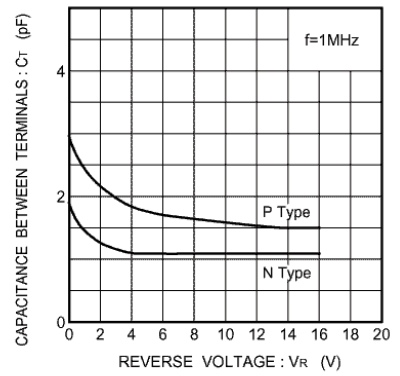

Capacitance between terminals characteristics

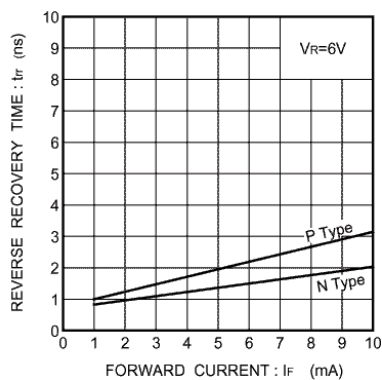

Reverse recovery time

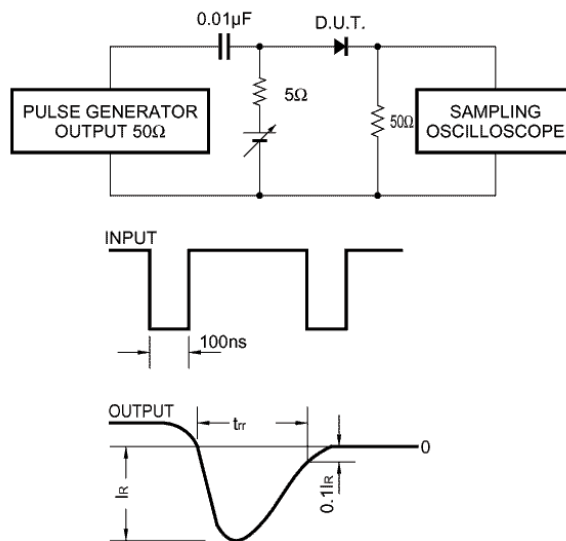

Reverse recovery time (t_{rr}) measurement circuit



TM

Micro Commercial Components

Ordering Information :

Device	Packing
Part Number-TP	Tape&Reel: 3Kpcs/Reel

Note : Adding "-HF" suffix for halogen free, eg. Part Number-TP-HF

IMPORTANT NOTICE

Micro Commercial Components Corp. reserves the right to make changes without further notice to any product herein to make corrections, modifications , enhancements , improvements , or other changes . **Micro Commercial Components Corp .** does not assume any liability arising out of the application or use of any product described herein; neither does it convey any license under its patent rights ,nor the rights of others . The user of products in such applications shall assume all risks of such use and will agree to hold **Micro Commercial Components Corp .** and all the companies whose products are represented on our website, harmless against all damages.

LIFE SUPPORT

MCC's products are not authorized for use as critical components in life support devices or systems without the express written approval of Micro Commercial Components Corporation.

CUSTOMER AWARENESS

Counterfeiting of semiconductor parts is a growing problem in the industry. Micro Commercial Components (MCC) is taking strong measures to protect ourselves and our customers from the proliferation of counterfeit parts. MCC strongly encourages customers to purchase MCC parts either directly from MCC or from Authorized MCC Distributors who are listed by country on our web page cited below. Products customers buy either from MCC directly or from Authorized MCC Distributors are genuine parts, have full traceability, meet MCC's quality standards for handling and storage. **MCC will not provide any warranty coverage or other assistance for parts bought from Unauthorized Sources.** MCC is committed to combat this global problem and encourage our customers to do their part in stopping this practice by buying direct or from authorized distributors.

www.mccsemi.com

www.s-manuals.com