

Digital transistors (built-in resistors)

DTA143XM / DTA143XE / DTA143XUA / DTA143XKA / DTA143XSA

●Features

- 1) Built-in bias resistors enable the configuration of an inverter circuit without connecting external input resistors (see equivalent circuit).
- 2) The bias resistors consist of thin-film resistors with complete isolation to allow positive biasing of the input. They also have the advantage of almost completely eliminating parasitic effects.
- 3) Only the on/off conditions need to be set for operation, making device design easy.

●Equivalent circuit

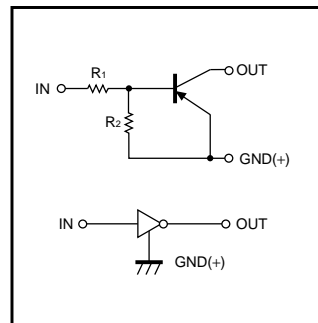

●Structure

PNP digital transistor (Built-in resistor type)

●External dimensions (Units : mm)

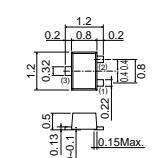
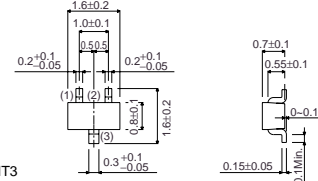
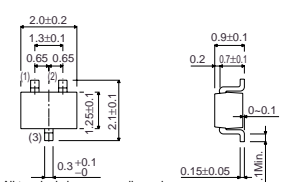
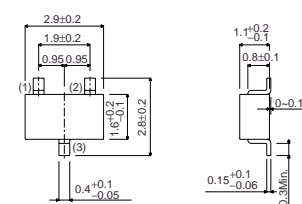
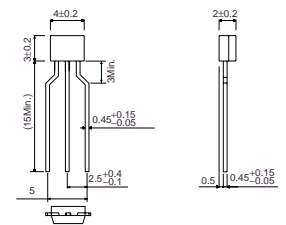
<p>DTA143XM</p>  <p>ROHM : VMT3 Abbreviated symbol : 33</p> <p>(1) IN (2) GND (3) OUT</p>	<p>DTA143XE</p>  <p>ROHM : EMT3 Abbreviated symbol : 33</p> <p>(1) GND (2) IN (3) OUT</p>
<p>DTA143XUA</p>  <p>ROHM : UMT3 EIAJ : SC-70 All terminals have same dimensions Abbreviated symbol : 33</p> <p>(1) GND (2) IN (3) OUT</p>	<p>DTA143XKA</p>  <p>ROHM : SMT3 EIAJ : SC-59 All terminals have same dimensions Abbreviated symbol : 33</p> <p>(1) GND (2) IN (3) OUT</p>
<p>DTA143XSA</p>  <p>ROHM : SPT EIAJ : SC-72</p> <p>(1) GND (2) OUT (3) IN</p>	

DTA143XM / DTA143XE / DTA143XUA DTA143XKA / DTA143XSA

Transistors

●Absolute maximum ratings (Ta=25°C)

Parameter	Symbol	Limits(DTA143X□)					Unit
		M	E	UA	KA	SA	
Supply voltage	V _{CC}	-50					V
Input voltage	V _i	-20~+7					V
Output current	I _o	-100					mA
	I _{c(Max.)}	-100					
Power dissipation	P _d	150	200		300		mW
Junction temperature	T _j	150					°C
Storage temperature	T _{stg}	-55~+150					°C

●Electrical characteristics (Ta=25°C)

Parameter	Symbol	Min.	Typ.	Max.	Unit	Conditions
Input voltage	V _{i(off)}	-	-	-0.3	V	V _{CC} =-5V, I _o =-100μA
	V _{i(on)}	-2.5	-	-		V _o =-0.3V, I _o =-20mA
Output voltage	V _{o(on)}	-	-0.1	-0.3	V	I _o /I _i =-10mA/-0.5mA
Input current	I _i	-	-	-1.8	mA	V _i =-5V
Output current	I _{o(off)}	-	-	-0.5	μA	V _{CC} =-50V, V _i =0V
DC current gain	G _i	30	-	-	-	V _o =-5V, I _o =-10mA
Input resistance	R ₁	3.29	4.7	6.11	kΩ	-
Resistance ratio	R ₂ /R ₁	1.7	2.1	2.6	-	-
Transition frequency	f _t	-	250	-	MHz	V _{CE} =-10V, I _E =5mA, f=100MHz *

* Transition frequency of the device

●Packaging specifications

Type	Package	VMT3	EMT3	UMT3	SMT3	SPT
	Packaging type	Taping	Taping	Taping	Taping	Taping
	Code	T2L	TL	T106	T146	TP
	Basic ordering unit (pieces)	8000	3000	3000	3000	5000
DTA143XM		○	-	-	-	-
DTA143XE		-	○	-	-	-
DTA143XUA		-	-	○	-	-
DTA143XKA		-	-	-	○	-
DTA143XSA		-	-	-	-	○

DTA143XM / DTA143XE / DTA143XUA
DTA143XKA / DTA143XSA

Transistors

●Electrical characteristic curves

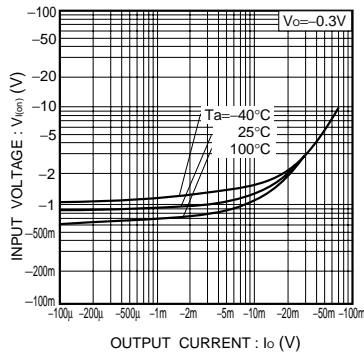

Fig.1 Input voltage vs. output current (ON characteristics)

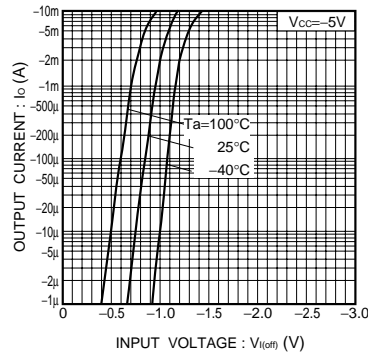

Fig.2 Output current vs. input voltage (OFF characteristics)

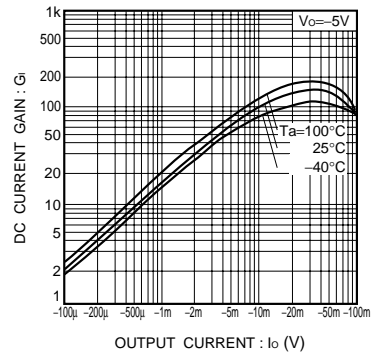

Fig.3 DC current gain vs. output current

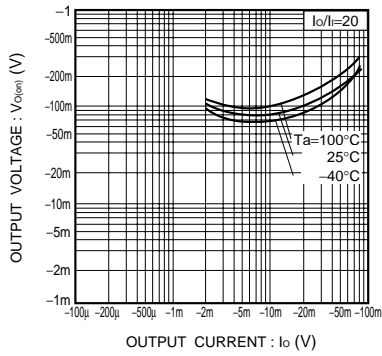

Fig.4 Output voltage vs. output current

www.s-manuals.com