

Power management, Dual-chip Bipolar Transistor

EMF33

●Applications

Power management circuit

●Features

- 1) DTB513Z (digital transistor) and 2SK3019 (MOS FET) are housed independently in the EMT6 package.
- 2) Power switching circuit in a single package.
- 3) Mounting cost and area can be cut in half.

●Structure

Epitaxial Planar Silicon Transistor

●Packaging specifications

Type	Package	Taping
	Code	T2R
	Basic ordering unit (pieces)	8000
EMF33		○

●Absolute maximum ratings (Ta=25°C)

<Tr1>				
Parameter	Symbol	Limits	Unit	
Supply voltage	V_{CC}	-12	V	
Input voltage	V_{IN}	-10 to +5	V	
Collector current	$I_{C(max)}$ *	-500	mA	

* Characteristics of built-in transistor.

<Tr2>				
Parameter	Symbol	Limits	Unit	
Drain-source voltage	V_{DSS}	30	V	
Gate-source voltage	V_{GSS}	±20	V	
Drain current	Continuous	I_D	100	mA
	Pulsed	I_{DP} *	200	mA
Reverse drain current	Continuous	I_{DR}	100	mA
	Pulsed	I_{DRP} *	200	mA

* $PW \leq 10ms$ DUTY CYCLE $\leq 50\%$

<Tr1, Tr2 in common>				
Parameter	Symbol	Limits	Unit	
Power dissipation	P_D *	150	mW / TOTAL	
		120	mW / ELEMENT	
Junction temperature	T_j	150	°C	
Range of storage temperature	T_{stg}	-55 to +150	°C	

* Each terminal mounted on a recommended land.

●Dimensions (Unit : mm)

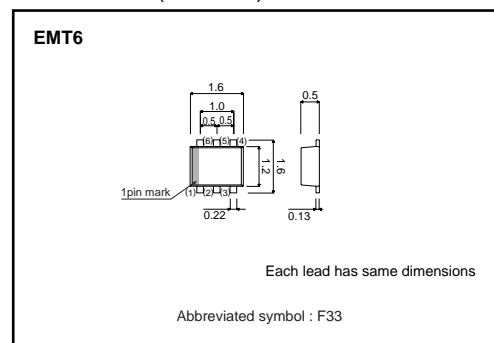

●Equivalent circuit

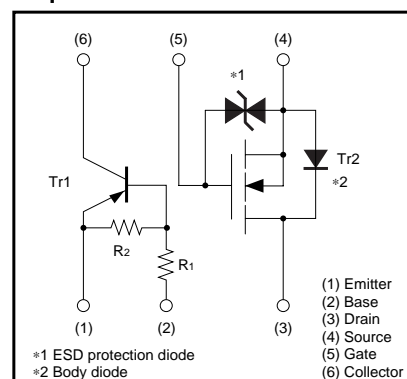

Tr1 : R1/R2=1kΩ/10kΩ
Tr2 : MOS FET

Transistors

●Electrical characteristics (Ta=25°C)

<Tr1>

Parameter	Symbol	Min.	Typ.	Max.	Unit	Conditions
Input voltage	$V_{I(off)}$	–	–	–0.3	V	$V_{CC} = -5V, I_O = -100\mu A$
	$V_{I(on)}$	–2.5	–	–	V	$V_O = -0.3V, I_O = -20mA$
Output voltage	$V_{O(on)}$	–	–60	–300	mV	$V_O = -100mA, I_I = -5mA$
Input current	I_I	–	–	–6.4	mA	$V_I = -5V$
Output current	$I_{O(off)}$	–	–	–0.5	uA	$V_{CC} = -12V, V_I = 0V$
DC current gain	G_I	140	–	–	–	$V_O = -5V, I_O = -100mA$
Transition frequency	f_T *	–	260	–	–	$V_{CE} = -10V, I_E = 5mA, f = 100MHz$
Input resistance	R1	0.7	1	1.3	k Ω	
Resistance ratio	R2/R1	8	10	12	–	

* Characteristics of built-in transistor.

<Tr2>

Parameter	Symbol	Min.	Typ.	Max.	Unit	Conditions
Gate-source leakage	I_{GSS}	–	–	± 1	μA	$V_{GS} = \pm 20V, V_{DS} = 0V$
Drain-source breakdown voltage	$V_{(BR)DSS}$	30	–	–	–	$I_D = 10\mu A, V_{GS} = 0A$
Zero gate voltage drain current	I_{DSS}	–	–	1.0	μA	$V_{DS} = 30V, V_{GS} = 0V$
Gate-threshold voltage	$V_{GS(th)}$	0.8	–	1.5	V	$V_{DS} = 3V, I_D = 100\mu A$
Static drain-source on-resistance	$R_{DS(on)}$	–	5	8	Ω	$I_D = 10mA, V_{GS} = 4V$
		–	7	13	Ω	$I_D = 1mA, V_{GS} = 2.5V$
Forward transfer admittance	$ Y_{fs} $	20	–	–	ms	$V_{DS} = 3V, I_D = 10mA$
Input capacitance	C_{iss}	–	13	–	pF	$V_{DS} = 5V$
Output capacitance	C_{oss}	–	9	–	pF	$V_{GS} = 0V$
Reverse transfer capacitance	C_{rss}	–	4	–	pF	$f = 1MHz$
Turn-on delay time	$t_{d(on)}$	–	15	–	ns	$I_D = 10mA$
Rise time	t_r	–	35	–	ns	$V_{DD} = 5V$
Turn-off delay time	$t_{d(off)}$	–	80	–	ns	$V_{GS} = 5V$
Fall time	t_f	–	80	–	ns	$R_L = 500\Omega$ $R_{GS} = 10\Omega$

Transistors

●Electrical characteristic curves

<Tr1>

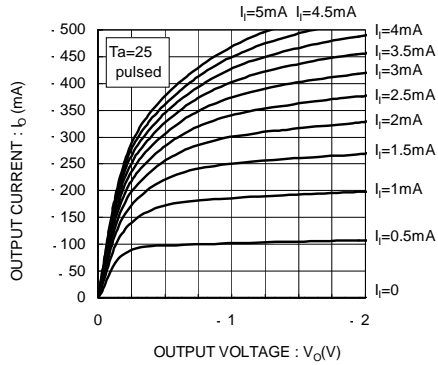

Fig.1 Output Current vs. Output Voltage

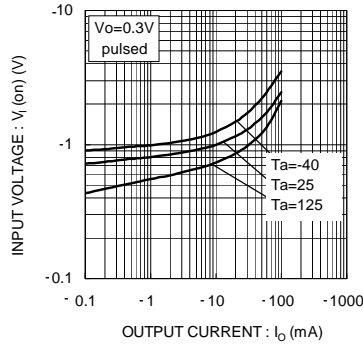

Fig.2 Input Voltage vs. Output Current

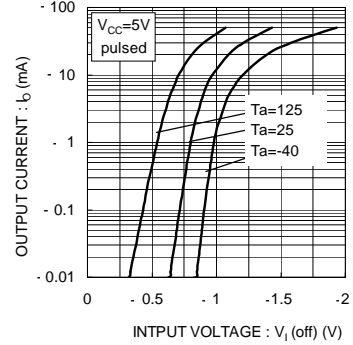

Fig.3 Output Current vs. Input Voltage

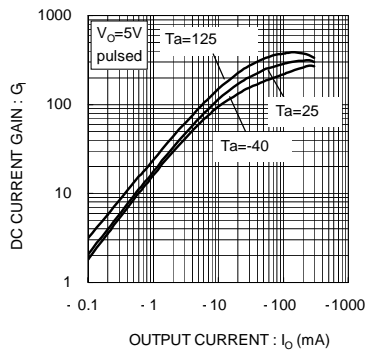

Fig.4 DC Current Gain vs. Output Current

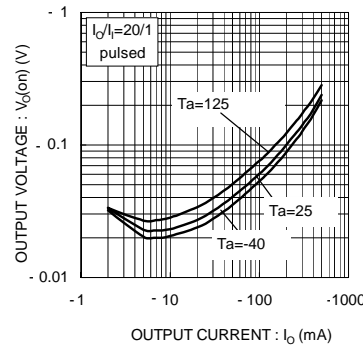

Fig.5 Output Voltage vs. Output Current

<Tr2>

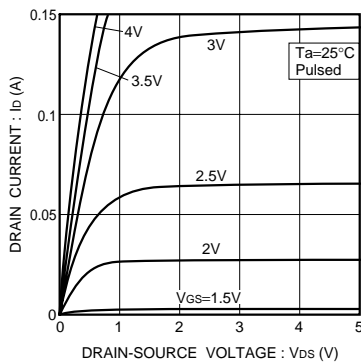

Fig.1 Typical output characteristics

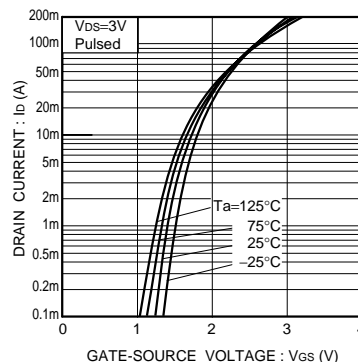

Fig.2 Typical transfer characteristics

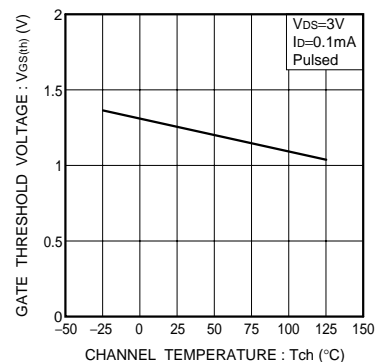

Fig.3 Gate threshold voltage vs. channel temperature

Transistors

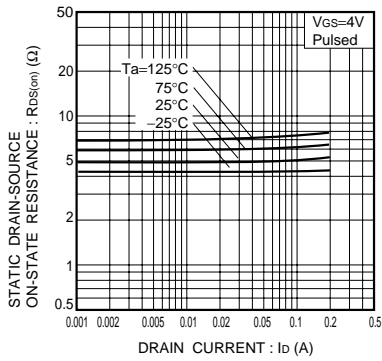

Fig.4 Static drain-source on-state resistance vs. drain current (I)

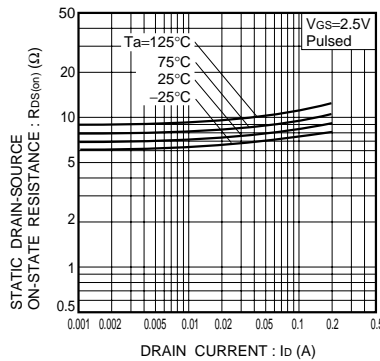

Fig.5 Static drain-source on-state resistance vs. drain current (II)

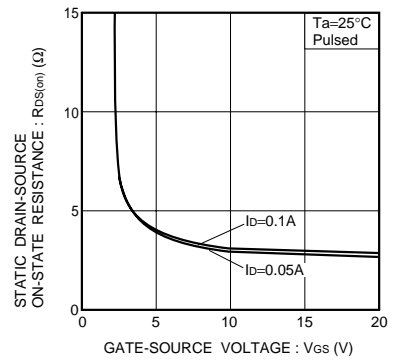

Fig.6 Static drain-source on-state resistance vs. gate-source voltage

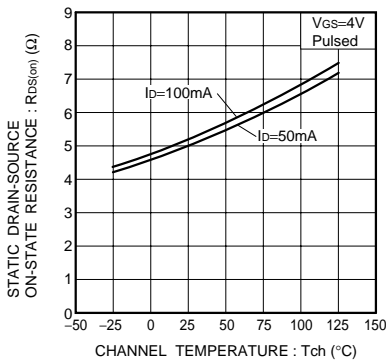

Fig.7 Static drain-source on-state resistance vs. channel temperature

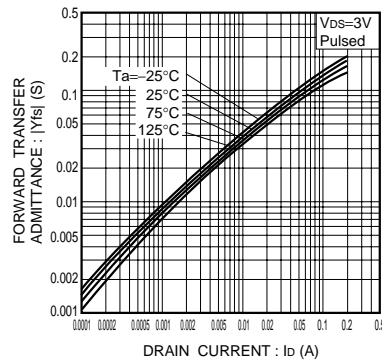

Fig.8 Forward transfer admittance vs. drain current

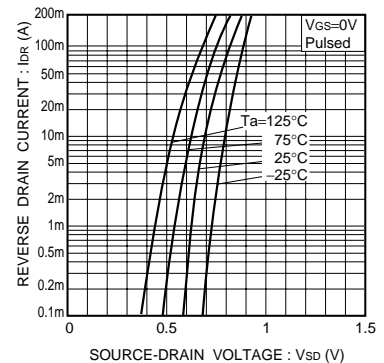

Fig.9 Reverse drain current vs. source-drain voltage (I)

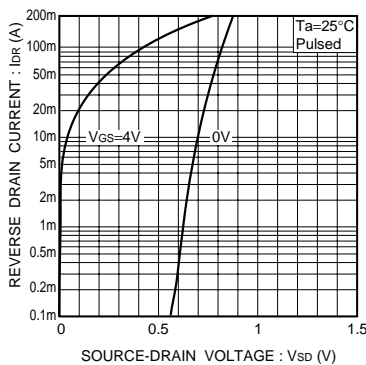

Fig.10 Reverse drain current vs. source-drain voltage (II)

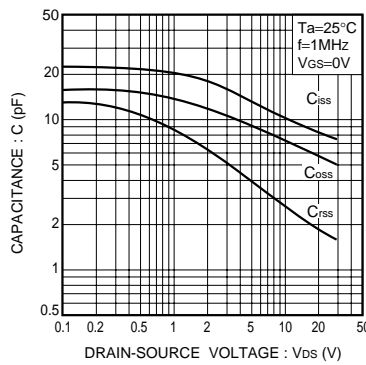

Fig.11 Typical capacitance vs. drain-source voltage

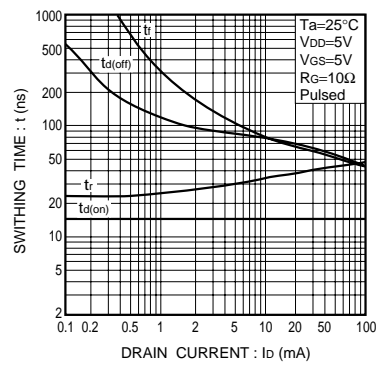

Fig.12 Switching characteristics

Notes

- No technical content pages of this document may be reproduced in any form or transmitted by any means without prior permission of ROHM CO.,LTD.
- The contents described herein are subject to change without notice. The specifications for the product described in this document are for reference only. Upon actual use, therefore, please request that specifications to be separately delivered.
- Application circuit diagrams and circuit constants contained herein are shown as examples of standard use and operation. Please pay careful attention to the peripheral conditions when designing circuits and deciding upon circuit constants in the set.
- Any data, including, but not limited to application circuit diagrams information, described herein are intended only as illustrations of such devices and not as the specifications for such devices. ROHM CO.,LTD. disclaims any warranty that any use of such devices shall be free from infringement of any third party's intellectual property rights or other proprietary rights, and further, assumes no liability of whatsoever nature in the event of any such infringement, or arising from or connected with or related to the use of such devices.
- Upon the sale of any such devices, other than for buyer's right to use such devices itself, resell or otherwise dispose of the same, no express or implied right or license to practice or commercially exploit any intellectual property rights or other proprietary rights owned or controlled by
- ROHM CO., LTD. is granted to any such buyer.
- Products listed in this document are no antiradiation design.

The products listed in this document are designed to be used with ordinary electronic equipment or devices (such as audio visual equipment, office-automation equipment, communications devices, electrical appliances and electronic toys).

Should you intend to use these products with equipment or devices which require an extremely high level of reliability and the malfunction of which would directly endanger human life (such as medical instruments, transportation equipment, aerospace machinery, nuclear-reactor controllers, fuel controllers and other safety devices), please be sure to consult with our sales representative in advance.

It is our top priority to supply products with the utmost quality and reliability. However, there is always a chance of failure due to unexpected factors. Therefore, please take into account the derating characteristics and allow for sufficient safety features, such as extra margin, anti-flammability, and fail-safe measures when designing in order to prevent possible accidents that may result in bodily harm or fire caused by component failure. ROHM cannot be held responsible for any damages arising from the use of the products under conditions out of the range of the specifications or due to non-compliance with the NOTES specified in this catalog.

Thank you for your accessing to ROHM product informations.

More detail product informations and catalogs are available, please contact your nearest sales office.

ROHM Customer Support System

THE AMERICAS / EUROPE / ASIA / JAPAN

www.rohm.com

Contact us : webmaster@rohm.co.jp

www.s-manuals.com