



FPF2411 — IntelliMAX™ 6 V / 6 A - Rated Bi-Directional Switch with Slew Rate Control and RCB

Features

- Capability: 6 V
- Low R_{ON}
 - 10 mΩ at 5 V at PWRA or PWRB (Typ.)
 - 12 mΩ at 3.8 V at PWRA or PWRB (Typ.)
- Maximum Current Capability: 6 A (Bi-Directional)
- Ultra-Low I_Q: <1 μA
- Active LOW Control Pin
- 2 ms Long Slew Rate
- Reverse Current Blocking (RCB) during OFF
- Robust ESD Capability:
 - 5 kV HBM, 2 kV CDM
 - 15 kV Air Discharge
 - 8 kV Contact Discharge Under IEC 61000-4-2

Description

The FPF2411 is a 6 V / 6 A-rated bi-directional load switch, consisting of a slew-rate-controlled, low-on-resistance, P-channel MOSFET switch with protection features. The slew-rate-controlled turn-on characteristic prevents inrush current and the resulting excessive voltage droop on the input power rails. The input voltage range operates from 2.3 V to 5.5 V.

Bi-directional switching allows reverse current from V_{OUT} to V_{IN}. The switching is controlled by active-LOW logic input the ONB pin. The FPF2411 is capable of interfacing directly with low-voltage control signal General-Purpose Input / Output (GPIO).

The FPF2411 is available in 12-bump, 1.235 mm x 1.625 mm Wafer-Level Chip-Scale Package (WLCSP) with 0.4 mm pitch.

Applications

- Smartphone / Tablet PC
- Mobile Devices
- Portable Media Devices

Ordering Information

Part Number	Top Mark	R _{ON} (Typ.) at 3.8 V _{IN}	Output Discharge	ONB Pin Functionality	Package
FPF2411BUCX_F130	QR	12 mΩ	No	Active LOW	12-Ball Wafer-Level Chip-Scale Package (WLCSP), 3 x 4 Array, 0.4 mm Pitch, 250 μm Ball

Application Diagrams

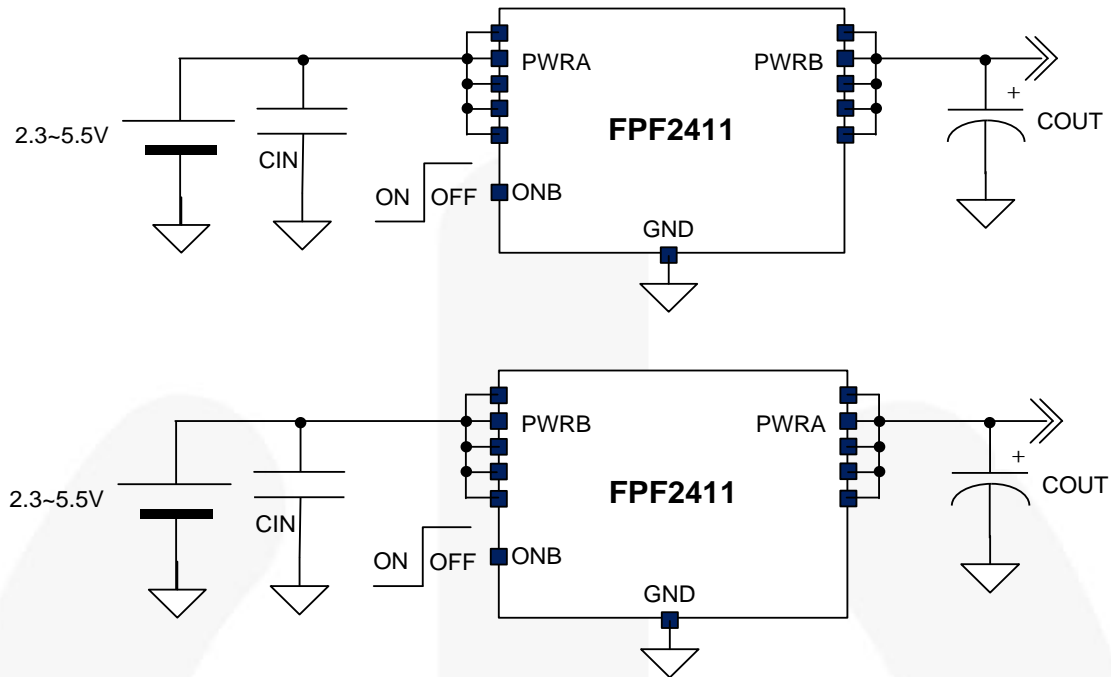
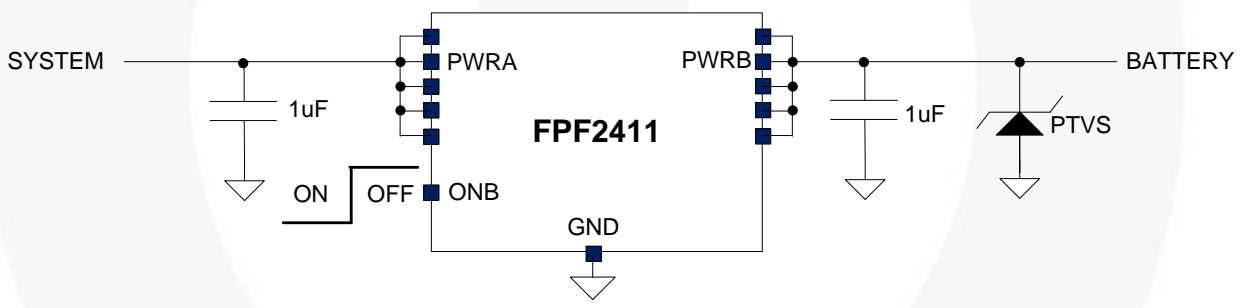

Figure 1. High-Level Application Diagrams



Note: Adding a PTVS such as RDP3101B is recommended at PWRB node in order to avoid device damage from surge or equivalent stress.

Figure 2. Battery Isolation Application

Block Diagrams

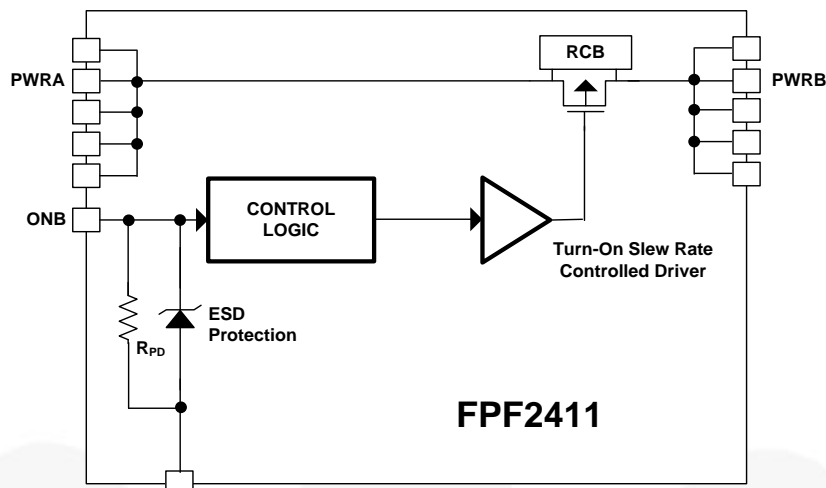

Figure 3. Block Diagram

Application Scenario

Table 1. PWRA and PWRB can be Input or Output, Depending on Scenario

PWRA	PWRB	ONB	Operations
X	X	HIGH	OFF state PWRA and PWRB are isolated. Current more than I_{SD} or I_{RCB} is NOT allowed.
2.3~5.5 V	Open	HIGH → LOW	Turn-on with 2 ms of t_R at PWRB.
Open	2.3~5.5 V	HIGH → LOW	Turn-on with 2 ms of t_R at PWRA.
2.3~5.5 V	Open	LOW	ON state Operating current is from PWRA. No problem with 6 A DC current flowing.
Open	2.3~5.5 V	LOW	ON state Operating current is from PWRB. No problem with 6 A DC current flowing.
2.3~5.5 V	Open	LOW → HIGH	Turn-off with 1 ms of t_F at PWRB.
Open	2.3~5.5 V	LOW → HIGH	Turn-off with 1 ms of t_F at PWRA.

Note:

1. X = Don't care.

Timing Diagrams

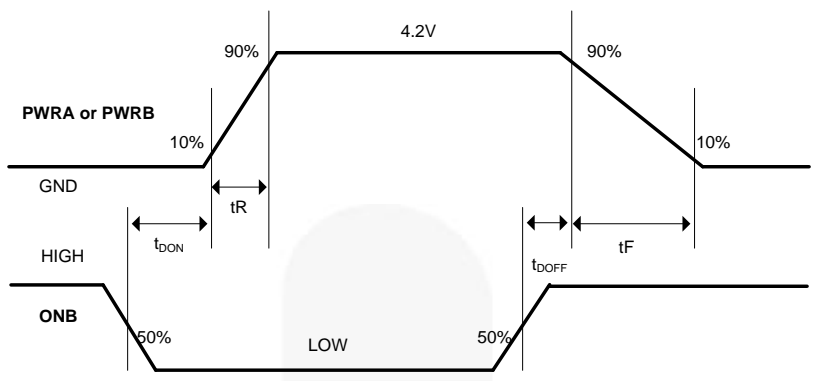

Figure 4. Dynamic Behavior

Pin Configuration

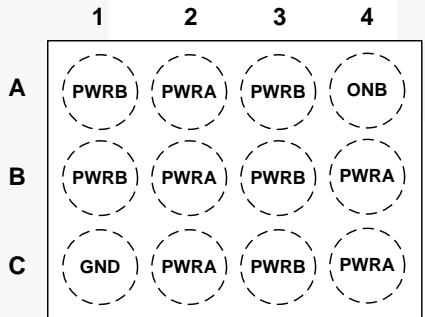
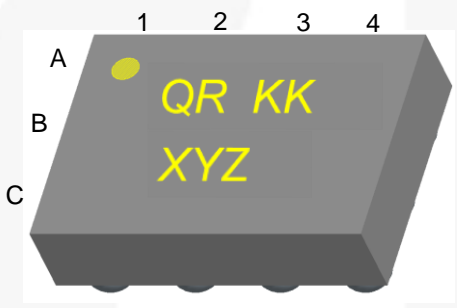

Figure 5. Top View

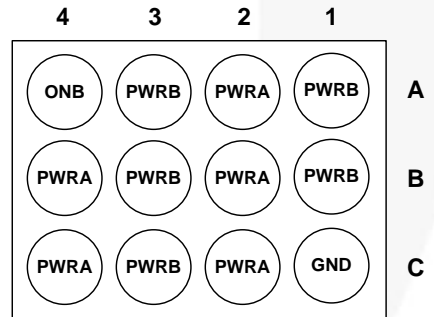
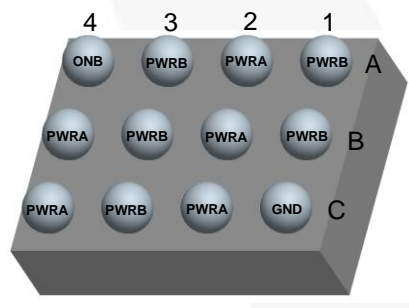

Figure 6. Bottom View

Pin Descriptions

Pin #	Name	Description
A2, B2, B4, C2, C4	PWRA	Power Input / Output: Bi-directional power path
A1, A3, B1, B3, C3	PWRB	Power Input / Output: Bi-directional power path
C1	GND	Ground
A4	ONB	ON/OFF Control Input: Active LOW.

Absolute Maximum Ratings

Stresses exceeding the absolute maximum ratings may damage the device. The device may not function or be operable above the recommended operating conditions and stressing the parts to these levels is not recommended. In addition, extended exposure to stresses above the recommended operating conditions may affect device reliability. The absolute maximum ratings are stress ratings only.

Symbol	Parameter	Min.	Max.	Unit
V _{PIN}	PWRA, PWRB, ONB to GND	-0.3	6.0	V
I _{SW}	Maximum Continuous Switch Current		6	A
t _{PD}	Total Power Dissipation at T _A =25°C		1.48	W
T _J	Operating Junction Temperature	-40	+150	°C
T _{STG}	Storage Junction Temperature	-65	+150	°C
Θ _{JA}	Thermal Resistance, Junction-to-Ambient (1in. ² Pad of 2 oz. Copper)		84.1 ⁽²⁾	°C/W
ESD	Electrostatic Discharge Capability	Human Body Model, JESD22-A114	5	kV
		Charged Device Model, JESD22-C101	2	
	IEC61000-4-2 System Level	Air Discharge (PWRA, PWRB, ONB to GND)	15	
		Contact Discharge (PWRA, PWRB, ONB to GND)	8	

Note:

2. Measured using 2S2P JEDEC std. PCB.

Recommended Operating Conditions

The Recommended Operating Conditions table defines the conditions for actual device operation. Recommended operating conditions are specified to ensure optimal performance to the datasheet specifications. Fairchild does not recommend exceeding them or designing to Absolute Maximum Ratings.

Symbol	Parameter	Min.	Max.	Unit
V _{PWRn}	PWRA, PWRB	2.3	5.5	V
T _A	Ambient Operating Temperature	-40	85	°C

DC / AC Characteristics

Unless otherwise noted, $V_{IN}=2.3$ to 5.5 V, $T_A=-40$ to 85°C ; typical values are at $PWRA$ or $PWRB=4.2$ V and $T_A=25^\circ\text{C}$.

Symbol	Parameter	Condition	Min.	Typ.	Max.	Unit
V_{PWRA} V_{PWRB}	Input Voltage		2.3		5.5	V
I_{SD}	Shutdown Current	PWRA=ONB=5.5 V, PWRB=Open OR PWRB=ONB=5.5 V, PWRA=Open			1	μA
I_{PWRA} I_{PWRB}	Quiescent Current	ONB=GND, $I_{OUT}=0$ mA			1	μA
R_{ON}	On-Resistance	PWRA, PWRB=3.8 V, $I_{OUT}=200$ mA, $T_A=25^\circ\text{C}$		12	17	m Ω
		PWRA, PWRB=5 V, $I_{OUT}=200$ mA, $T_A=25^\circ\text{C}$		10	16	
V_{IH}	ONB, Input Logic HIGH Voltage ⁽³⁾	PWRn=4.5 V, $I_{LOAD}=50$ μA , T_A (Max.) = 60°C	4.3			V
		PWRn=3.6 V, $I_{LOAD}=50$ μA , T_A (Max.) = 60°C	3.4			
V_{IL}	ONB, Input Logic LOW Voltage ⁽³⁾	PWRn=4.5 V, $I_{LOAD}=50$ μA , T_A (Max.) = 60°C			0.4	
		PWRn=3.6 V, $I_{LOAD}=50$ μA , T_A (Max.) = 60°C			0.4	
R_{PD}	Pull-Down Resistance at ONB			500	700	k Ω
Dynamic Characteristics: see definitions below						
t_{DON}	Turn-On Delay ^(4,5,6)	PWRA or PWRB =4.2 V, $R_L=10$ Ω , $C_L=1$ μF , ONB=HIGH to LOW		1.5		ms
t_R	Rise Time ^(4,5,6)			3.0		
t_{ON}	Turn-On Time ^(4,5,6)			4.5		
t_{DOFF}	Turn-Off Delay ^(4,5,7)	PWRA or PWRB =4.2 V, $R_L=100$ Ω , $C_L=1$ μF , ONB=LOW to HIGH		5.5		ms
t_F	Fall Time ^(4,5,7)			1.0		
t_{OFF}	Turn-Off Time ^(4,5,7)			6.5		

Notes:

- V_{IH}/V_{IL} is tested under 50 μA current load
- This parameter is guaranteed by design and characterization; not production tested.
- $t_{DON}/t_{DOFF}/t_R/t_F$ are defined in Figure 4.
- $t_{ON}=t_R + t_{DON}$.
- $t_{OFF}=t_F + t_{DOFF}$.

Table 2. V_{IH} / V_{IL} [V]

$I_{LOAD} \setminus V_{BAT}$	2.7 V	3.7 V	4.35 V
0.1 mA	1.8 / 0.7	2.9 / 0.9	3.4 / 1.0
1 mA	1.1 / 0.7	2.1 / 0.9	2.8 / 1.0
3 mA	1.1 / 0.7	2.1 / 0.9	2.7 / 1.0
5 mA	1.0 / 0.7	2.0 / 0.9	2.7 / 1.0
10 mA	0.9 / 0.7	1.9 / 0.8	2.4 / 0.9
30 mA	0.9 / 0.7	1.5 / 0.8	2.2 / 0.9
50 mA	0.9 / 0.7	1.2 / 0.8	1.9 / 0.9
100 mA	0.9 / 0.7	1.0 / 0.8	1.1 / 0.9

Typical Performance Characteristics

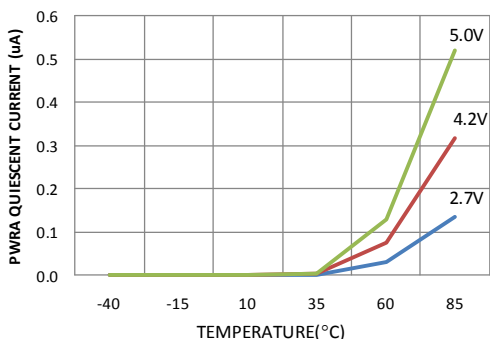

Figure 7. PWRA Quiescent Supply Current vs. Temperature

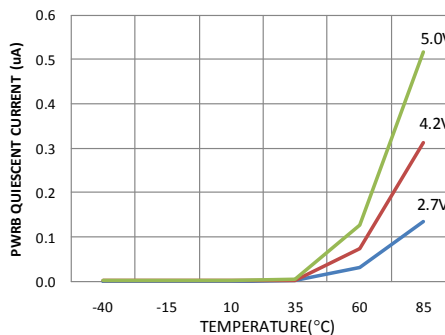

Figure 8. PWRB Quiescent Supply Current vs. Temperature

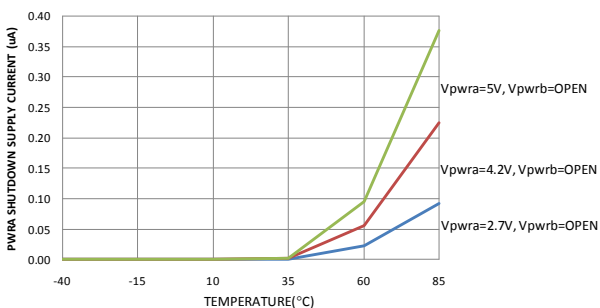

Figure 9. PWRA Shutdown Supply Current vs. Temperature

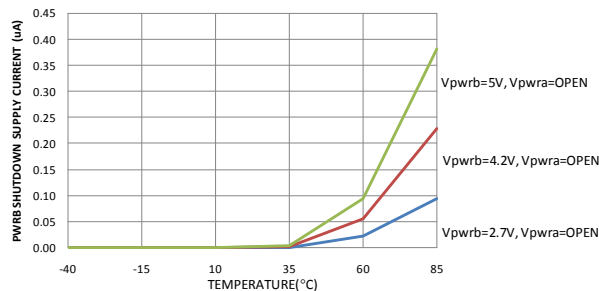

Figure 10. PWRB Shutdown Supply Current vs. Temperature

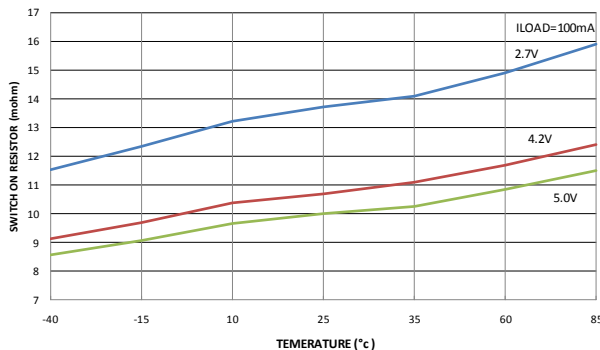

Figure 11. Switch On Resistance vs. Temperature

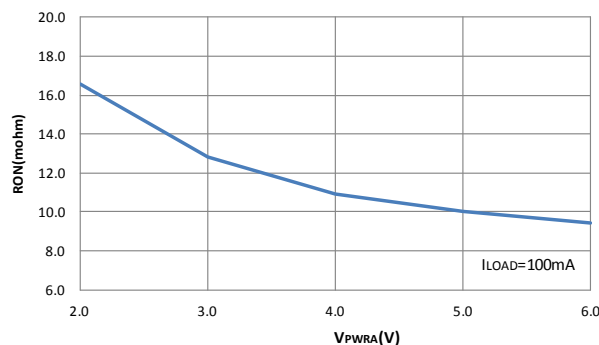

Figure 12. On Resistance vs. PWRA Voltage

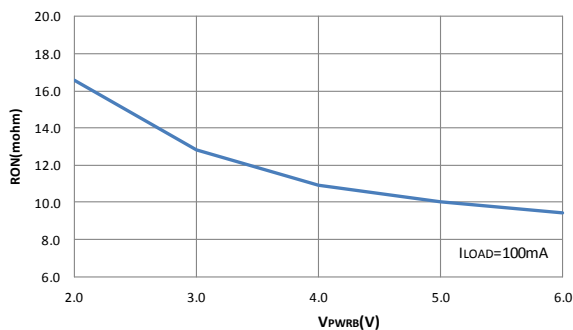

Figure 13. On Resistance vs. PWRB Voltage

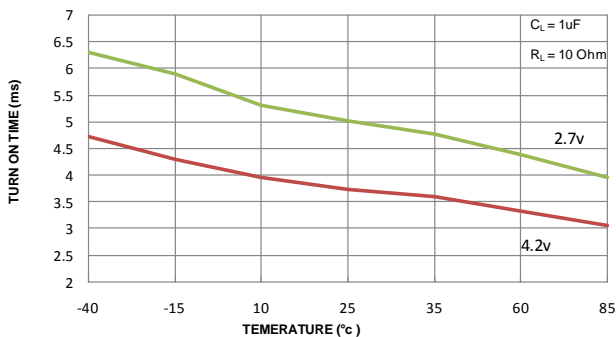

Figure 14. Switch On Time vs. Temperature

Typical Performance Characteristics (Continued)

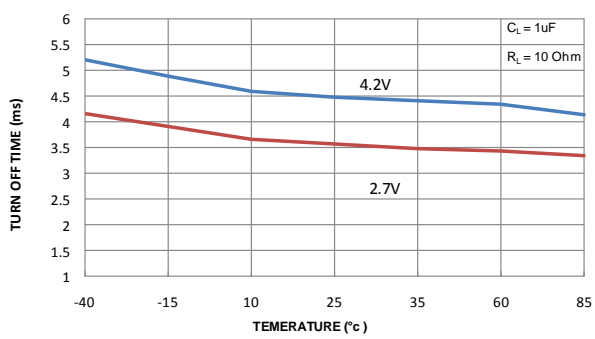

Figure 15. Switch Off Time vs. Temperature

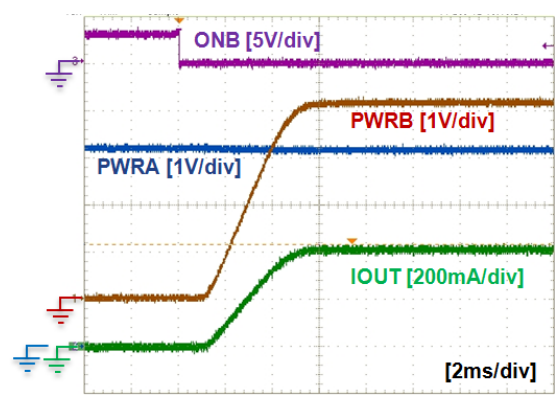

Figure 16. Turn-On Response ($V_{IN}=4.2\text{ V}$, $C_{IN}=1\text{ }\mu\text{F}$, $C_{OUT}=1\text{ }\mu\text{F}$, $R_L=10\text{ }\Omega$)

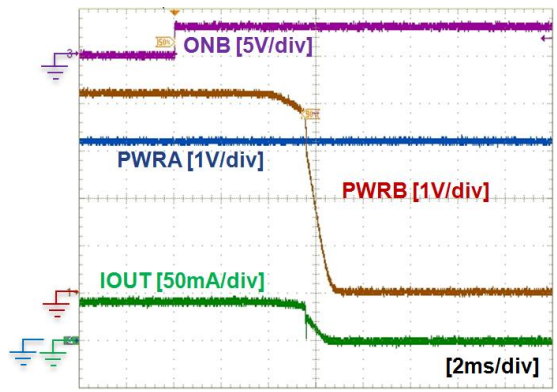

Figure 17. Turn-OFF Response ($V_{IN}=4.2\text{ V}$, $C_{IN}=1\text{ }\mu\text{F}$, $C_{OUT}=1\text{ }\mu\text{F}$, $R_L=100\text{ }\Omega$)

Operation and Application Description

The FPF2411 is an ultra-low- R_{ON} P-channel load switch with bi-directional controlled turn-on and Reverse Current Blocking (RCB). The core is a 12 m Ω P-channel MOSFET and controller capable of functioning over a wide input operating range of 2.3 V to 5.5 V. The ONB pin, active-LOW; controls the state of the switch. RCB functionality blocks unwanted reverse current during OFF states by power switch isolation between PWRA and PWRB.

Inrush Current

Inrush current occurs when the device is turned on. Inrush current is dependent on output capacitance and slew rate control capability, as expressed by:

$$I_{INRUSH} = C_{OUT} \times \frac{V_{IN} - V_{INITIAL}}{t_R} + I_{LOAD}$$

where:

C_{OUT} : Output capacitance;

t_R : Slew rate or rise time at V_{OUT} ;

V_{IN} : Input voltage;

$V_{INITIAL}$: Initial voltage at C_{OUT} , usually GND; and

I_{LOAD} : Load current.

Higher inrush current causes higher input voltage drop, depending on the distributed input resistance and input capacitance. High inrush current can cause problems.

FPF2411 has a 3 ms of slew rate capability under 4.2 V_{IN} at 1 μ F of C_{OUT} and 10 Ω of R_L . Inrush current can be minimized and no input voltage drop appears, as shown in Figure 16.

Reverse-Current Blocking

The reverse-current blocking feature protects the input source against current flow from output to input when the load switch is off by changing the internal body diode direction.

Bypass Capacitor

To limit the voltage drop on the input supply caused by transient inrush current when the switch turns on into a discharged load capacitor; a capacitor must be placed between the PWRA or PWRB and GND pins. A ceramic capacitor of at least 1 μ F placed close to the pins is usually sufficient.

Board Layout

For best performance, all traces should be as short as possible. To be most effective, the input and output capacitors should be placed close to the device to minimize the effect that parasitic trace inductance on normal and short-circuit operation. Using wide traces or large copper planes for all pins (PWRA, PWRB, ONB, and GND) minimizes the parasitic electrical effects and the case-to-ambient thermal impedance.

WLCSP Packing - Embossed Tape

FPF2411BUCX Pin1 at 1 o'clock Rev0



Packing Description:
 WLCSP products are classified under Moisture Sensitive Level 1 and are packed in moisture barrier bag for added protection.
 The carrier tape is made from dissipative polystyrene or polycarbonate resin. The cover tape is a multilayer film primarily composed of polyester film, adhesive layer, heat activated sealant, and anti-static sprayed agent. These reeled parts in standard option are shipped with 3000 units per 178 mm diameter reel. Up to three reels are packed in each intermediate box. The reels is made of polystyrene plastic(anti-static coated or intrinsic).
 These full reels are individually barcode labeled and placed inside a pizza box made of recyclable corrugated brown paper with a Fairchild logo printing. The reel is packed single reel in the pizza box. And these pizza boxes are placed inside a barcode labeled shipping box which comes in different sizes depending on the number of parts shipped.

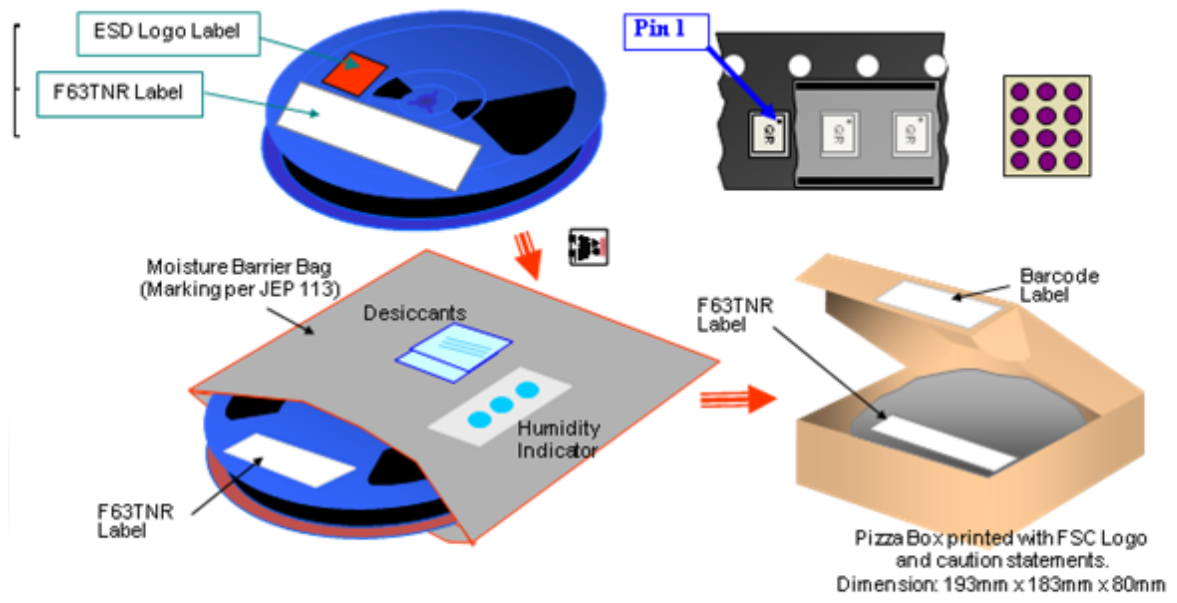

ESD Logo Label sample



F63TNR Label sample

LOT: F63TNR10000000 F63TNR Label DFC1: P1215MA QTY1: DFC2: QTY2:	QTY: 3000 SPEC: To be determine SPEC REV: Green Component RoHS COMPLIANT	2 nd Level Interconnect 1. Category G1 2. Maximum safe temperature: 260 deg C 3. MSL: 1 FAIRCHILD SEMICONDUCTOR
---	--	--

Tape Leader and Trailer Configuration

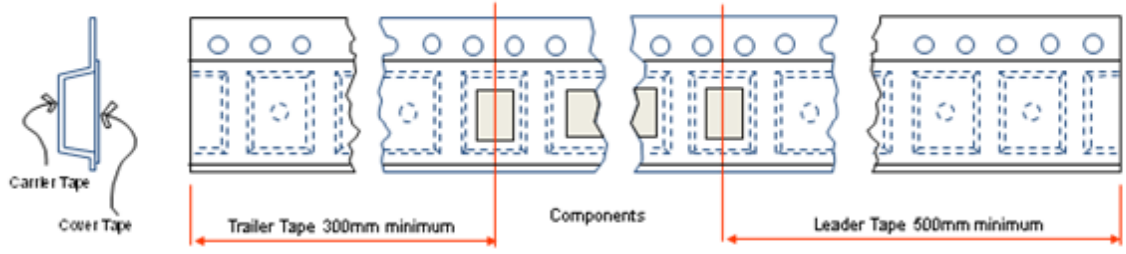

WLCSP Embossed Tape Dimension

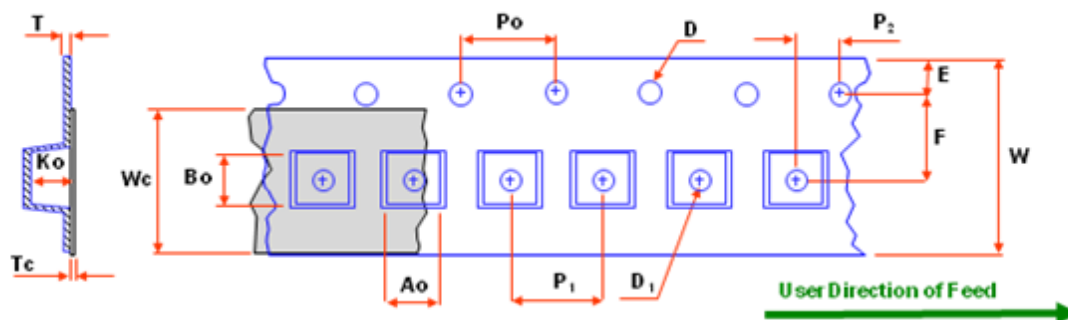

Dimensions are in millimeters

Package	A ₀ +/-0.05	B ₀ +/-0.05	D +0.10	D ₁ min.	E +/-0.1	F +/-0.1	K ₀ +/-0.05	P ₁ TYP	P ₀ TYP	P ₂ +/-0.05	T TYP	T _c +/-0.005	W +/-0.3	W _c TYP
FPF2411UCX	1.55	1.95	1.50	0.5	1.75	3.5	0.75	4	4	2.0	0.25	0.06	8	5.3

Notes: A₀, B₀, and K₀ dimensions are determined with respect to the EIA/JEDEC RS-481 rotational and lateral movement requirements (see sketches A, B, and C).



Shipping Reel Dimension

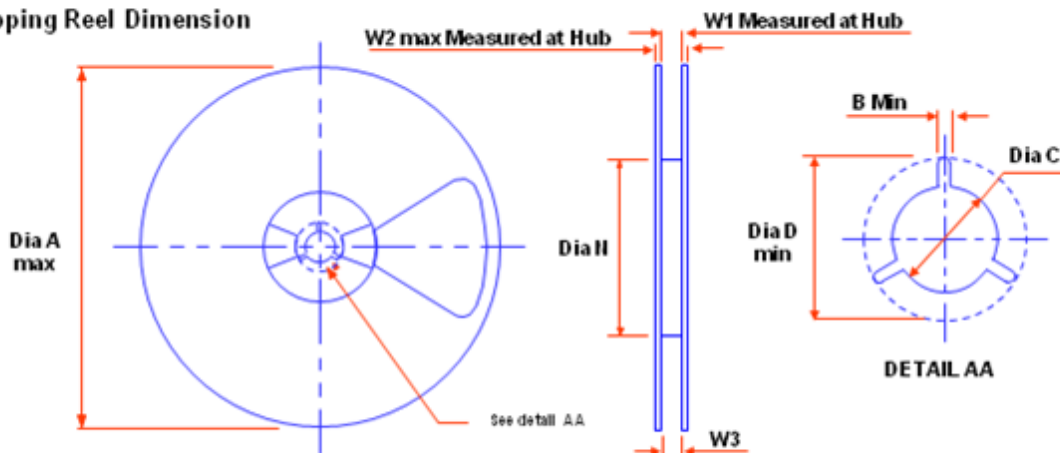

Dimensions are in millimeters

Tape Width	Dia A max	Dim B min	Dia C +5/-2	Dia D min	Dim N min	Dim W1 +2/-0	Dim W2 max	Dim W3 (LSL - USL)
8	178	1.5	13	20.2	55	8.4	14.4	7.9~10.4

Rev 1, 25102011

Physical Dimensions

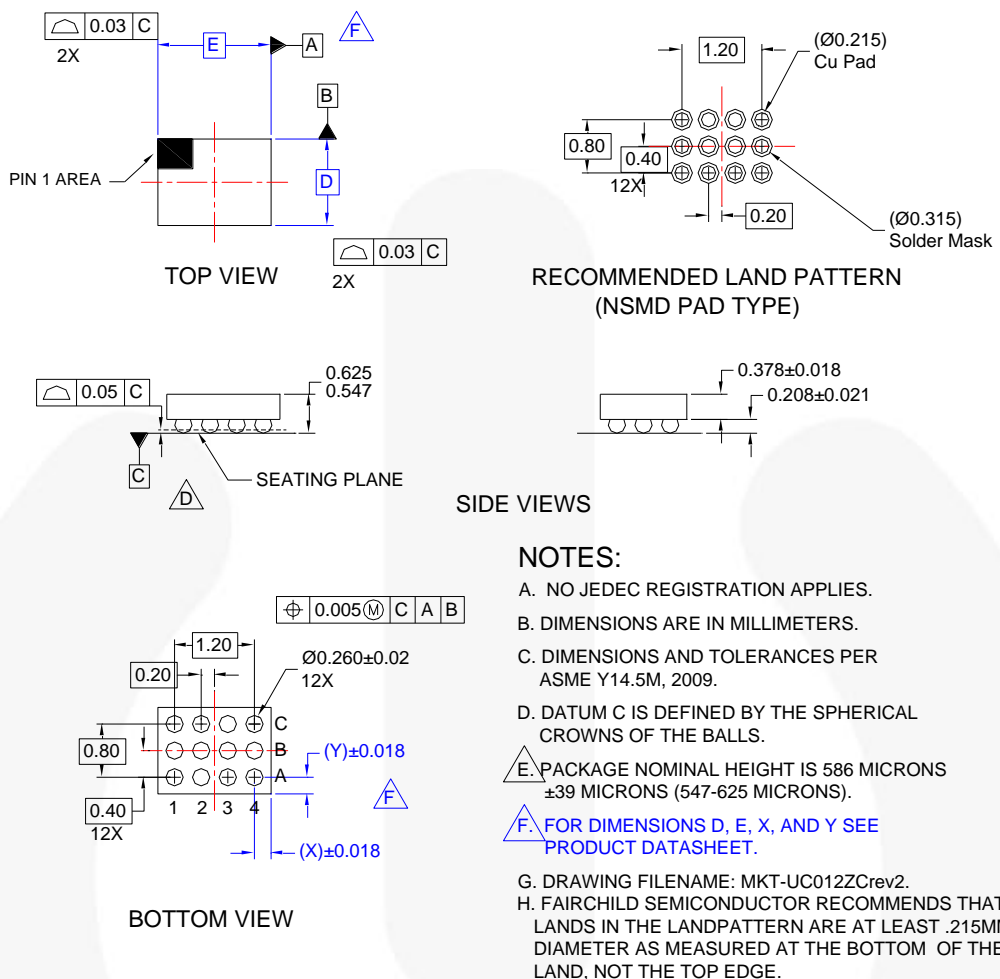

Figure 18. 12-Ball, 3x4 Array, 0.4 mm Pitch, 250 µm Ball, Wafer-Level Chip-Scale Package (WLCSP)

Nominal Values

Bump Pitch	Overall Package Height	Silicon Thickness	Solder Bump Height	Solder Bump Diameter
0.4 mm	0.586 mm	0.378 mm	0.208 mm	0.260 mm





Product-Specific Dimensions

Product	D	E	X	Y
FPF2411BUCX_F130	1.235 mm	1.625 mm	0.2125 mm	0.2175 mm



TRADEMARKS

The following includes registered and unregistered trademarks and service marks, owned by Fairchild Semiconductor and/or its global subsidiaries, and is not intended to be an exhaustive list of all such trademarks.

- | | | | |
|--|--|---|---|
| AccuPower™ | F-PFS™ | OPTOPLANAR® |  SYSTEM GENERAL® |
| AttitudeEngine™ | FRFET® |  ® | TinyBoost® |
| Awinda® | Global Power Resource™ | Power Supply WebDesigner™ | TinyBuck® |
| AX-CAP®* | GreenBridge™ | PowerTrench® | TinyCalc™ |
| BitSiC™ | Green FPS™ | PowerXS™ | TinyLogic® |
| Build it Now™ | Green FPS™ e-Series™ | Programmable Active Droop™ | TINYOPTO™ |
| CorePLUS™ | Gmax™ | QFET® | TinyPower™ |
| CorePOWER™ | GTO™ | QS™ | TinyPWM™ |
| CROSSVOLT™ | IntelliMAX™ | Quiet Series™ | TinyWire™ |
| CTL™ | ISOPLANAR™ | RapidConfigure™ | TranSiC™ |
| Current Transfer Logic™ | Making Small Speakers Sound Louder and Better™ |  ™ | TriFault Detect™ |
| DEUXPEED® | MegaBuck™ | Saving our world, 1mW/WkW at a time™ | TRUECURRENT®* |
| Dual Cool™ | MICROCOUPLER™ | SignalWise™ | µSerDes™ |
| EcoSPARK® | MicroFET™ | SmartMax™ |  SerDes™ |
| EfficientMax™ | MicroPak™ | SMART START™ | UHC® |
| ESBC™ | MicroPak2™ | Solutions for Your Success™ | Ultra FRFET™ |
|  Fairchild® | MillerDrive™ | SPM® | UniFET™ |
| Fairchild Semiconductor® | MotionMax™ | STEALTH™ | VCC™ |
| FACT Quiet Series™ | MotionGrid® | SuperFET™ | VisualMax™ |
| FACT® | MTI® | SuperSOT™-3 | VoltagePlus™ |
| FAST® | MTX® | SuperSOT™-6 | XS™ |
| FastvCore™ | MVN® | SuperSOT™-8 | Xsens™ |
| FETBench™ | mWSaver® | SupreMOS® | 仙童™ |
| FPS™ | OptoHiT™ | SyncFET™ | |
| | OPTOLOGIC® | Sync-Lock™ | |

* Trademarks of System General Corporation, used under license by Fairchild Semiconductor.

DISCLAIMER

FAIRCHILD SEMICONDUCTOR RESERVES THE RIGHT TO MAKE CHANGES WITHOUT FURTHER NOTICE TO ANY PRODUCTS HEREIN TO IMPROVE RELIABILITY, FUNCTION, OR DESIGN. TO OBTAIN THE LATEST, MOST UP-TO-DATE DATASHEET AND PRODUCT INFORMATION, VISIT OUR WEBSITE AT [HTTP://WWW.FAIRCHILDSEMI.COM](http://www.fairchildsemi.com). FAIRCHILD DOES NOT ASSUME ANY LIABILITY ARISING OUT OF THE APPLICATION OR USE OF ANY PRODUCT OR CIRCUIT DESCRIBED HEREIN; NEITHER DOES IT CONVEY ANY LICENSE UNDER ITS PATENT RIGHTS, NOR THE RIGHTS OF OTHERS. THESE SPECIFICATIONS DO NOT EXPAND THE TERMS OF FAIRCHILD'S WORLDWIDE TERMS AND CONDITIONS, SPECIFICALLY THE WARRANTY THEREIN, WHICH COVERS THESE PRODUCTS.

LIFE SUPPORT POLICY

FAIRCHILD'S PRODUCTS ARE NOT AUTHORIZED FOR USE AS CRITICAL COMPONENTS IN LIFE SUPPORT DEVICES OR SYSTEMS WITHOUT THE EXPRESS WRITTEN APPROVAL OF FAIRCHILD SEMICONDUCTOR CORPORATION.

As used herein:

1. Life support devices or systems are devices or systems which, (a) are intended for surgical implant into the body or (b) support or sustain life, and (c) whose failure to perform when properly used in accordance with instructions for use provided in the labeling, can be reasonably expected to result in a significant injury of the user.
2. A critical component in any component of a life support, device, or system whose failure to perform can be reasonably expected to cause the failure of the life support device or system, or to affect its safety or effectiveness.

ANTI-COUNTERFEITING POLICY

Fairchild Semiconductor Corporation's Anti-Counterfeiting Policy. Fairchild's Anti-Counterfeiting Policy is also stated on our external website, www.fairchildsemi.com, under Sales Support.

Counterfeiting of semiconductor parts is a growing problem in the industry. All manufacturers of semiconductor products are experiencing counterfeiting of their parts. Customers who inadvertently purchase counterfeit parts experience many problems such as loss of brand reputation, substandard performance, failed applications, and increased cost of production and manufacturing delays. Fairchild is taking strong measures to protect ourselves and our customers from the proliferation of counterfeit parts. Fairchild strongly encourages customers to purchase Fairchild parts either directly from Fairchild or from Authorized Fairchild Distributors who are listed by country on our web page cited above. Products customers buy either from Fairchild directly or from Authorized Fairchild Distributors are genuine parts, have full traceability, meet Fairchild's quality standards for handling and storage and provide access to Fairchild's full range of up-to-date technical and product information. Fairchild and our Authorized Distributors will stand behind all warranties and will appropriately address any warranty issues that may arise. Fairchild will not provide any warranty coverage or other assistance for parts bought from Unauthorized Sources. Fairchild is committed to combat this global problem and encourage our customers to do their part in stopping this practice by buying direct or from authorized distributors.

PRODUCT STATUS DEFINITIONS

Definition of Terms

Datasheet Identification	Product Status	Definition
Advance Information	Formative / In Design	Datasheet contains the design specifications for product development. Specifications may change in any manner without notice.
Preliminary	First Production	Datasheet contains preliminary data; supplementary data will be published at a later date. Fairchild Semiconductor reserves the right to make changes at any time without notice to improve design.
No Identification Needed	Full Production	Datasheet contains final specifications. Fairchild Semiconductor reserves the right to make changes at any time without notice to improve the design.
Obsolete	Not In Production	Datasheet contains specifications on a product that is discontinued by Fairchild Semiconductor. The datasheet is for reference information only.

Rev. I74

www.s-manuals.com