

# MBRF20100CT

Preferred Device

## SWITCHMODE™ Schottky Power Rectifier

The SWITCHMODE Power Rectifier employs the Schottky Barrier principle in a large area metal-to-silicon power diode. State-of-the-art geometry features epitaxial construction with oxide passivation and metal overlay contact. Ideally suited for use as rectifiers in very low-voltage, high-frequency switching power supplies, free wheeling diodes and polarity protection diodes.

- Highly Stable Oxide Passivated Junction
- Very Low Forward Voltage Drop
- Matched Dual Die Construction
- High Junction Temperature Capability
- High dv/dt Capability
- Excellent Ability to Withstand Reverse Avalanche Energy Transients
- Guardring for Stress Protection
- Epoxy Meets UL94, V<sub>O</sub> at 1/8"
- Electrically Isolated. No Isolation Hardware Required.
- UL Recognized File #E69369 (Note 1.)

### Mechanical Characteristics

- Case: Epoxy, Molded
- Weight: 1.9 grams (approximately)
- Finish: All External Surfaces Corrosion Resistant and Terminal Leads are Readily Solderable
- Lead Temperature for Soldering Purposes: 260°C Max. for 10 Seconds
- Shipped 50 units per plastic tube
- Marking: B20100

### MAXIMUM RATINGS

Please See the Table on the Following Page

1. UL Recognized mounting method is per Figure 4.



ON Semiconductor™

<http://onsemi.com>

### SCHOTTKY BARRIER RECTIFIER 20 AMPERES 100 VOLTS

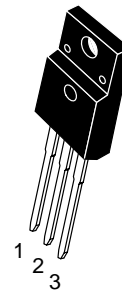
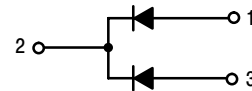

ISOLATED TO-220  
CASE 221D  
STYLE 3

### MARKING DIAGRAM

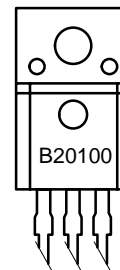

B20100 = Device Code

### ORDERING INFORMATION

Device	Package	Shipping
MBRF20100CT	TO-220	50 Units/Rail

Preferred devices are recommended choices for future use and best overall value.

# MBRF20100CT

## MAXIMUM RATINGS (Per Leg)

Rating	Symbol	Value	Unit
Peak Repetitive Reverse Voltage Working Peak Reverse Voltage DC Blocking Voltage	$V_{RRM}$ $V_{RWM}$ $V_R$	100	Volts
Average Rectified Forward Current (Rated $V_R$ ), $T_C = 133^\circ\text{C}$	$I_{F(AV)}$	10 20	Amps
Peak Repetitive Forward Current (Rated $V_R$ , Square Wave, 20 kHz), $T_C = 133^\circ\text{C}$	$I_{FRM}$	20	Amps
Non-repetitive Peak Surge Current (Surge applied at rated load conditions halfwave, single phase, 60 Hz)	$I_{FSM}$	150	Amps
Peak Repetitive Reverse Surge Current (2.0 $\mu\text{s}$ , 1.0 kHz)	$I_{RRM}$	0.5	Amp
Operating Junction and Storage Temperature Range	$T_J, T_{stg}$	-65 to +150	$^\circ\text{C}$
Voltage Rate of Change (Rated $V_R$ )	$dv/dt$	10000	$\text{V}/\mu\text{s}$
RMS Isolation Voltage (t = 1.0 second, R.H. $\leq 30\%$ , $T_A = 25^\circ\text{C}$ ) (Note 2.)	$V_{iso1}$	4500	Volts
Per Figure 3.	$V_{iso2}$	3500	
Per Figure 4. (Note 1.)	$V_{iso3}$	1500	
Per Figure 5.			

## THERMAL CHARACTERISTICS (Per Leg)

Maximum Thermal Resistance, Junction to Case	$R_{\theta JC}$	3.5	$^\circ\text{C}/\text{W}$
Lead Temperature for Soldering Purposes: 1/8" from Case for 5 Seconds	$T_L$	260	$^\circ\text{C}$

## ELECTRICAL CHARACTERISTICS (Per Leg)

Characteristic	Symbol	Max	Unit
Maximum Instantaneous Forward Voltage (Note 3.) ( $i_F = 10$ Amp, $T_C = 25^\circ\text{C}$ ) ( $i_F = 10$ Amp, $T_C = 125^\circ\text{C}$ ) ( $i_F = 20$ Amp, $T_C = 25^\circ\text{C}$ ) ( $i_F = 20$ Amp, $T_C = 125^\circ\text{C}$ )	$v_F$	0.85 0.75 0.95 0.85	Volts
Maximum Instantaneous Reverse Current (Note 3.) (Rated DC Voltage, $T_C = 25^\circ\text{C}$ ) (Rated DC Voltage, $T_C = 125^\circ\text{C}$ )	$i_R$	0.15 150	mA

1. UL Recognized mounting method is per Figure 4.
2. Proper strike and creepage distance must be provided.
3. Pulse Test: Pulse Width = 300  $\mu\text{s}$ , Duty Cycle  $\leq 2.0\%$

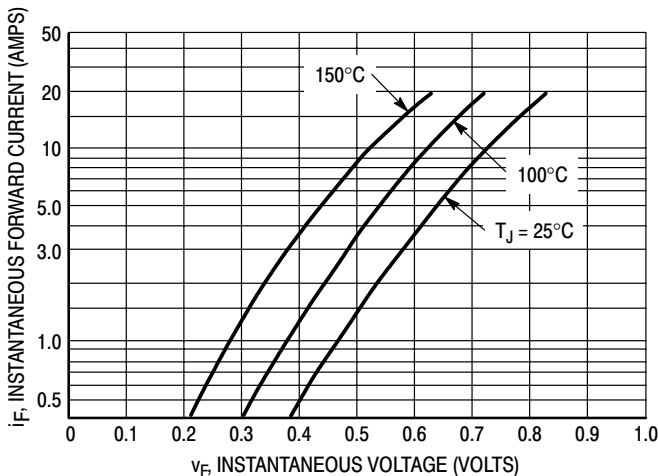

Figure 1. Typical Forward Voltage Per Diode

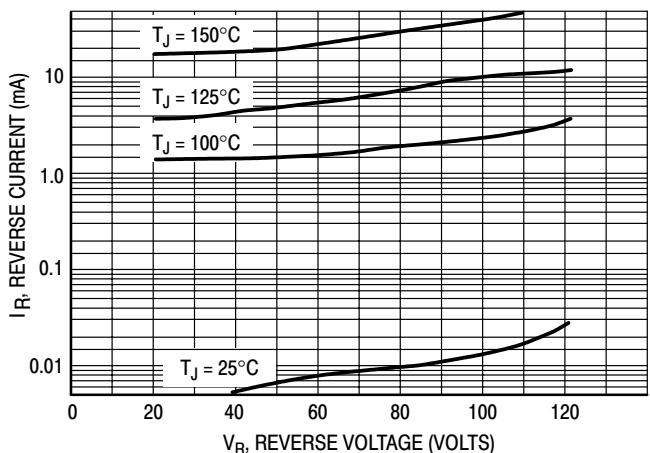

Figure 2. Typical Reverse Current Per Diode

TEST CONDITIONS FOR ISOLATION TESTS\*

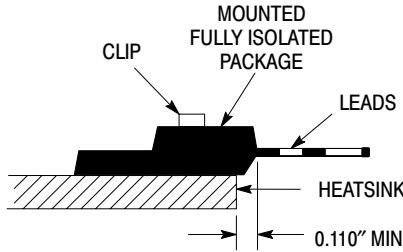

Figure 3. Clip Mounting Position for Isolation Test Number 1

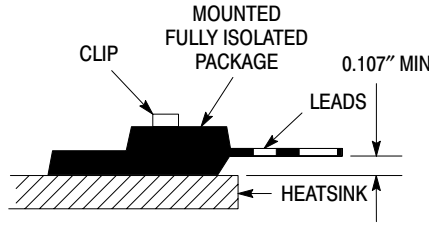

Figure 4. Clip Mounting Position for Isolation Test Number 2

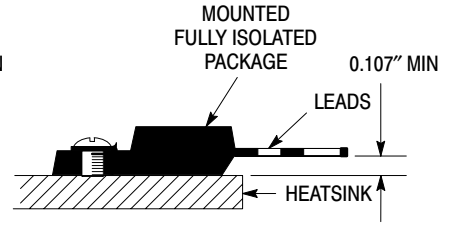
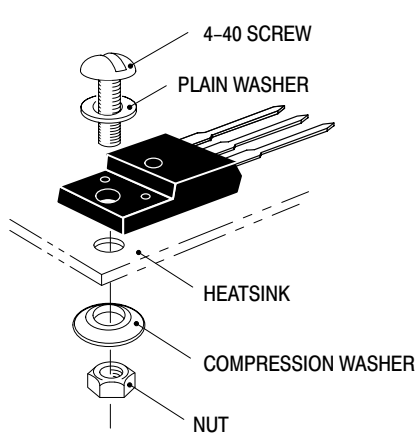

Figure 5. Screw Mounting Position for Isolation Test Number 3

\* Measurement made between leads and heatsink with all leads shorted together.

MOUNTING INFORMATION\*\*



6a. Screw-Mounted

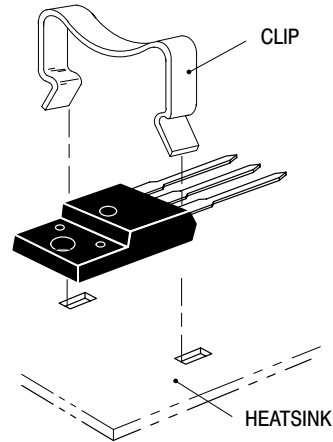

6b. Clip-Mounted

Figure 6. Typical Mounting Techniques

Laboratory tests on a limited number of samples indicate, when using the screw and compression washer mounting technique, a screw torque of 6 to 8 in · lbs is sufficient to provide maximum power dissipation capability. The compression washer helps to maintain a constant pressure on the package over time and during large temperature excursions.

Destructive laboratory tests show that using a hex head 4-40 screw, without washers, and applying a torque in excess of 20 in · lbs will cause the plastic to crack around the mounting hole, resulting in a loss of isolation capability.

Additional tests on slotted 4-40 screws indicate that the screw slot fails between 15 to 20 in · lbs without adversely affecting the package. However, in order to positively ensure the package integrity of the fully isolated device, ON Semiconductor does not recommend exceeding 10 in · lbs of mounting torque under any mounting conditions.

\*\*For more information about mounting power semiconductors see Application Note AN1040.

# MBRF20100CT

## PACKAGE DIMENSIONS

TO-220  
FULLPAK  
CASE 221D-02  
ISSUE D

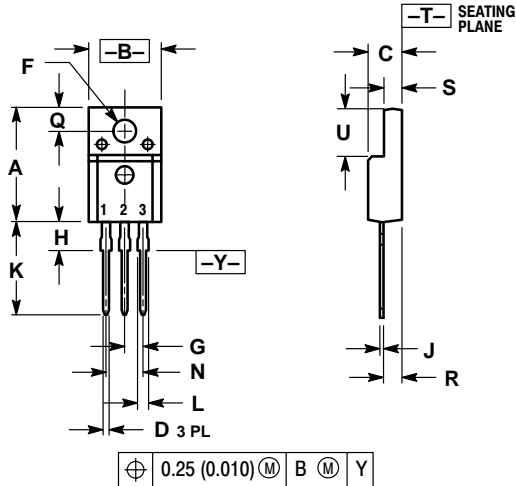

- NOTES:  
1. DIMENSIONING AND TOLERANCING PER ANSI Y14.5M, 1982.  
2. CONTROLLING DIMENSION: INCH.

DIM	INCHES		MILLIMETERS	
	MIN	MAX	MIN	MAX
A	0.621	0.629	15.78	15.97
B	0.394	0.402	10.01	10.21
C	0.181	0.189	4.60	4.80
D	0.026	0.034	0.67	0.86
F	0.121	0.129	3.08	3.27
G	0.100 BSC		2.54 BSC	
H	0.123	0.129	3.13	3.27
J	0.018	0.025	0.46	0.64
K	0.500	0.562	12.70	14.27
L	0.045	0.060	1.14	1.52
N	0.200 BSC		5.08 BSC	
Q	0.126	0.134	3.21	3.40
R	0.107	0.111	2.72	2.81
S	0.096	0.104	2.44	2.64
U	0.259	0.267	6.58	6.78

- STYLE 3:  
PIN 1. ANODE  
2. CATHODE  
3. ANODE

SWITCHMODE is a trademark of Semiconductor Components Industries, LLC.

**ON Semiconductor** and  are trademarks of Semiconductor Components Industries, LLC (SCILLC). SCILLC reserves the right to make changes without further notice to any products herein. SCILLC makes no warranty, representation or guarantee regarding the suitability of its products for any particular purpose, nor does SCILLC assume any liability arising out of the application or use of any product or circuit, and specifically disclaims any and all liability, including without limitation special, consequential or incidental damages. "Typical" parameters which may be provided in SCILLC data sheets and/or specifications can and do vary in different applications and actual performance may vary over time. All operating parameters, including "Typicals" must be validated for each customer application by customer's technical experts. SCILLC does not convey any license under its patent rights nor the rights of others. SCILLC products are not designed, intended, or authorized for use as components in systems intended for surgical implant into the body, or other applications intended to support or sustain life, or for any other application in which the failure of the SCILLC product could create a situation where personal injury or death may occur. Should Buyer purchase or use SCILLC products for any such unintended or unauthorized application, Buyer shall indemnify and hold SCILLC and its officers, employees, subsidiaries, affiliates, and distributors harmless against all claims, costs, damages, and expenses, and reasonable attorney fees arising out of, directly or indirectly, any claim of personal injury or death associated with such unintended or unauthorized use, even if such claim alleges that SCILLC was negligent regarding the design or manufacture of the part. SCILLC is an Equal Opportunity/Affirmative Action Employer.

### PUBLICATION ORDERING INFORMATION

#### NORTH AMERICA Literature Fulfillment:

Literature Distribution Center for ON Semiconductor  
P.O. Box 5163, Denver, Colorado 80217 USA  
**Phone:** 303-675-2175 or 800-344-3860 Toll Free USA/Canada  
**Fax:** 303-675-2176 or 800-344-3867 Toll Free USA/Canada  
**Email:** ONlit@hibbertco.com  
Fax Response Line: 303-675-2167 or 800-344-3810 Toll Free USA/Canada

#### N. American Technical Support: 800-282-9855 Toll Free USA/Canada

#### EUROPE: LDC for ON Semiconductor – European Support

**German Phone:** (+1) 303-308-7140 (Mon-Fri 2:30pm to 7:00pm CET)  
**Email:** ONlit-german@hibbertco.com  
**French Phone:** (+1) 303-308-7141 (Mon-Fri 2:00pm to 7:00pm CET)  
**Email:** ONlit-french@hibbertco.com  
**English Phone:** (+1) 303-308-7142 (Mon-Fri 12:00pm to 5:00pm GMT)  
**Email:** ONlit@hibbertco.com

#### EUROPEAN TOLL-FREE ACCESS\*: 00-800-4422-3781

\*Available from Germany, France, Italy, UK, Ireland

#### CENTRAL/SOUTH AMERICA:

**Spanish Phone:** 303-308-7143 (Mon-Fri 8:00am to 5:00pm MST)  
**Email:** ONlit-spanish@hibbertco.com  
**Toll-Free from Mexico:** Dial 01-800-288-2872 for Access –  
then Dial 866-297-9322

#### ASIA/PACIFIC: LDC for ON Semiconductor – Asia Support

**Phone:** 303-675-2121 (Tue-Fri 9:00am to 1:00pm, Hong Kong Time)  
**Toll Free from Hong Kong & Singapore:**  
**001-800-4422-3781**  
**Email:** ONlit-asia@hibbertco.com

#### JAPAN: ON Semiconductor, Japan Customer Focus Center

4-32-1 Nishi-Gotanda, Shinagawa-ku, Tokyo, Japan 141-0031  
**Phone:** 81-3-5740-2700  
**Email:** r14525@onsemi.com

#### ON Semiconductor Website: <http://onsemi.com>

For additional information, please contact your local Sales Representative.

[www.s-manuals.com](http://www.s-manuals.com)