

### General Description

The MIC5219 is an efficient linear voltage regulator with high peak output current capability, very-low-dropout voltage, and better than 1% output voltage accuracy. Dropout is typically 10mV at light loads and less than 500mV at full load.

The MIC5219 is designed to provide a peak output current for start-up conditions where higher inrush current is demanded. It features a 500mA peak output rating. Continuous output current is limited only by package and layout.

The MIC5219 can be enabled or shut down by a CMOS or TTL compatible signal. When disabled, power consumption drops nearly to zero. Dropout ground current is minimized to help prolong battery life. Other key features include reversed-battery protection, current limiting, overtemperature shutdown, and low noise performance with an ultra-low-noise option.

The MIC5219 is available in adjustable or fixed output voltages in the space-saving 6-pin (2mm × 2mm) MLF<sup>®</sup>, 6-pin (2mm × 2mm) Thin MLF<sup>®</sup> SOT-23-5 and MM8<sup>®</sup> 8-pin power MSOP packages. For higher power requirements see the MIC5209 or MIC5237.

All support documentation can be found on Micrel's web site at [www.micrel.com](http://www.micrel.com).

### Features

- 500mA output current capability
  - SOT-23-5 package - 500mA peak**
  - 2mm×2mm MLF<sup>®</sup> package - 500mA continuous**
  - 2mm×2mm Thin MLF<sup>®</sup> package - 500mA continuous**
  - MSOP-8 package - 500mA continuous**
- Low 500mV maximum dropout voltage at full load
- Extremely tight load and line regulation
- Tiny SOT-23-5 and MM8™ power MSOP-8 package
- Ultra-low-noise output
- Low temperature coefficient
- Current and thermal limiting
- Reversed-battery protection
- CMOS/TTL-compatible enable/shutdown control
- Near-zero shutdown current

### Applications

- Laptop, notebook, and palmtop computers
- Cellular telephones and battery-powered equipment
- Consumer and personal electronics
- PC Card V<sub>CC</sub> and V<sub>PP</sub> regulation and switching
- SMPS post-regulator/DC-to-DC modules
- High-efficiency linear power supplies

### Typical Applications

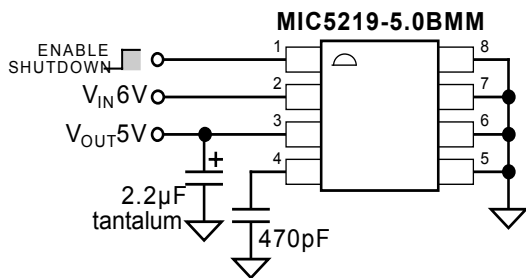

5V Ultra-Low-Noise Regulator

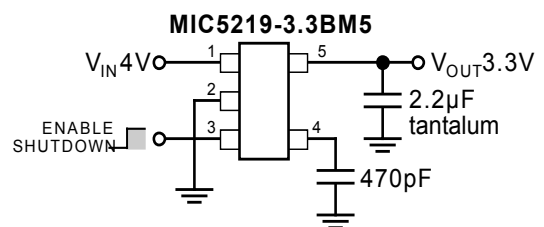

3.3V Ultra-Low-Noise Regulator

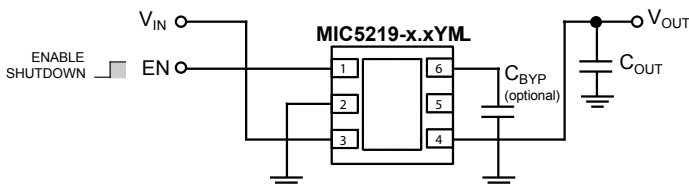

Ultra-Low-Noise Regulator (Fixed)

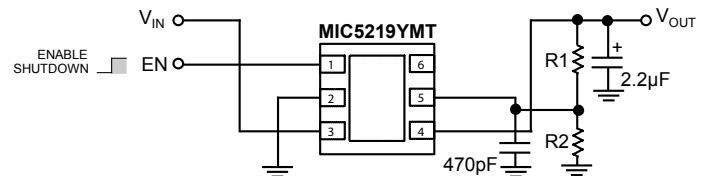

Ultra-Low-Noise Regulator (Adjustable)

MM8 is a registered trademark of Micrel, Inc.

MicroLeadFrame and MLF are registered trademarks of Amkor Technology, Inc..

Micrel, Inc. • 2180 Fortune Drive • San Jose, CA 95131 • USA • tel + 1 (408) 944-0800 • fax + 1 (408) 474-1000 • <http://www.micrel.com>

## Ordering Information

Part Number		Marking		Volts	Temp. Range	Package
Standard	Pb-Free	Standard	Pb-Free*			
MIC5219-2.5BMM	MIC5219-2.5YMM	—	—	2.5V	-40°C to +125°C	MSOP-8
MIC5219-2.85BMM	MIC5219-2.85YMM	—	—	2.85V	-40°C to +125°C	MSOP-8
MIC5219-3.0BMM	MIC5219-3.0YMM	—	—	3.0V	-40°C to +125°C	MSOP-8
MIC5219-3.3BMM	MIC5219-3.3YMM	—	—	3.3V	-40°C to +125°C	MSOP-8
MIC5219-3.6BMM	MIC5219-3.6YMM	—	—	3.6V	-40°C to +125°C	MSOP-8
MIC5219-5.0BMM	MIC5219-5.0YMM	—	—	5.0V	-40°C to +125°C	MSOP-8
MIC5219BMM	MIC5219YMM	—	—	Adj.	-40°C to +125°C	MSOP-8
MIC5219-2.5BM5	MIC5219-2.5YM5	LG25	<u>LG</u> 25	2.5V	-40°C to +125°C	SOT-23-5
MIC5219-2.6BM5	MIC5219-2.6YM5	LG26	<u>LG</u> 26	2.6V	-40°C to +125°C	SOT-23-5
MIC5219-2.7BM5	MIC5219-2.7YM5	LG27	<u>LG</u> 27	2.7V	-40°C to +125°C	SOT-23-5
MIC5219-2.8BM5	MIC5219-2.8YM5	LG28	<u>LG</u> 28	2.8V	-40°C to +125°C	SOT-23-5
MIC5219-2.8BML	MIC5219-2.8YML	G28	<u>G</u> 28	2.8V	-40°C to +125°C	6-Pin 2x2 MLF <sup>®</sup>
MIC5219-2.85BM5	MIC5219-2.85YM5	LG2J	<u>LG</u> 2J	2.85V	-40°C to +125°C	SOT-23-5
MIC5219-2.9BM5	MIC5219-2.9YM5	LG29	<u>LG</u> 29	2.9V	-40°C to +125°C	SOT-23-5
MIC5219-3.1BM5	MIC5219-3.1YM5	LG31	<u>LG</u> 31	3.1V	-40°C to +125°C	SOT-23-5
MIC5219-3.0BM5	MIC5219-3.0YM5	LG30	<u>LG</u> 30	3.0V	-40°C to +125°C	SOT-23-5
MIC5219-3.0BML	MIC5219-3.0YML	G30	<u>G</u> 30	3.0V	-40°C to +125°C	6-Pin 2x2 MLF <sup>®</sup>
MIC5219-3.3BM5	MIC5219-3.3YM5	LG33	<u>LG</u> 33	3.3V	-40°C to +125°C	SOT-23-5
MIC5219-3.3BML	MIC5219-3.3YML	G33	<u>G</u> 33	3.3V	-40°C to +125°C	6-Pin 2x2 MLF <sup>®</sup>
MIC5219-3.6BM5	MIC5219-3.6YM5	LG36	<u>LG</u> 36	3.6V	-40°C to +125°C	SOT-23-5
MIC5219-5.0BM5	MIC5219-5.0YM5	LG50	<u>LG</u> 50	5.0V	-40°C to +125°C	SOT-23-5
MIC5219BM5	MIC5219YM5	LGAA	<u>LG</u> AA	Adj.	-40°C to +125°C	SOT-23-5
	MIC5219YMT		GAA	Adj.	-40°C to +125°C	6-Pin 2x2 Thin MLF <sup>®</sup> **
	MIC5219-5.0YMT		G50	5.0V	-40°C to +125°C	6-Pin 2x2 Thin MLF <sup>®</sup> **

Other voltages available. Consult Micrel for details.

\* Over/underbar may not be to scale. \*\* Pin 1 identifier = ▲.

## Pin Configuration

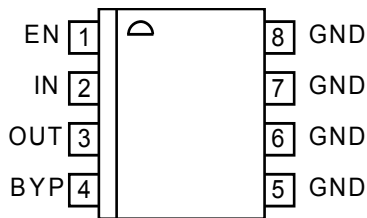

**MIC5219-x.xBMM / MM8<sup>®</sup> / MSOP-8**  
Fixed Voltages  
(Top View)

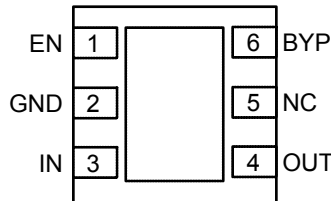

**MIC5219-x.xBML**  
6-Pin 2mm x 2mm MLF<sup>®</sup> (ML)  
(Top View)

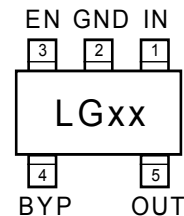

**MIC5219-x.xBM5 / SOT-23-5**  
Fixed Voltages  
(Top View)

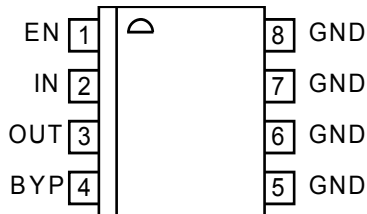

**MIC5219YMM / MIC5219BMM**  
MM8<sup>®</sup> MSOP-8  
Adjustable Voltage  
(Top View)

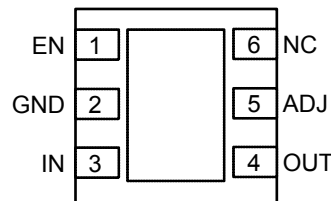

**MIC5219YMT**  
6-Pin 2mm x 2mm Thin MLF<sup>®</sup> (MT)  
(Top View)

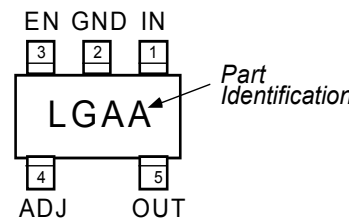

**MIC5219BM5 / SOT-23-5**  
Adjustable Voltage  
(Top View)

**Pin Description**

Pin No. MLF-6 TMLF-6	Pin No. MSOP-8	Pin No. SOT-23-5	Pin Name	Pin Function
3	2	1	IN	Supply Input.
2	5–8	2	GND	Ground: MSOP-8 pins 5 through 8 are internally connected.
4	3	5	OUT	Regulator Output.
1	1	3	EN	Enable (Input): CMOS compatible control input. Logic high = enable; logic low or open = shutdown.
6	4 (fixed)	4 (fixed)	BYP	Reference Bypass: Connect external 470pF capacitor to GND to reduce output noise. May be left open.
5(NC)	4 (adj.)	4 (adj.)	ADJ	Adjust (Input): Feedback input. Connect to resistive voltage-divider network.
EP	—	—	GND	Ground: Internally connected to the exposed pad. Connect externally to GND pin.

**Absolute Maximum Ratings<sup>(1)</sup>**

Supply Input Voltage ( $V_{IN}$ ).....	-20V to +20V
Power Dissipation ( $P_D$ ).....	Internally Limited
Junction Temperature ( $T_J$ ).....	-40°C to +125°C
Storage Temperature ( $T_S$ ).....	-65°C to +150°C
Lead Temperature (Soldering, 5 sec.).....	260°C

**Operating Ratings<sup>(2)</sup>**

Supply Input Voltage ( $V_{IN}$ ).....	+2.5V to +12V
Enable Input Voltage ( $V_{EN}$ ).....	0V to $V_{IN}$
Junction Temperature ( $T_J$ ).....	-40°C to +125°C
Package Thermal Resistance.....	see Table 1

**Electrical Characteristics<sup>(3)</sup>**

$V_{IN} = V_{OUT} + 1.0V$ ;  $C_{OUT} = 4.7\mu F$ ,  $I_{OUT} = 100\mu A$ ;  $T_J = 25^\circ C$ , **bold** values indicate  $-40^\circ C \leq T_J \leq +125^\circ C$ ; unless noted.

Symbol	Parameter	Conditions	Min	Typical	Max	Units
$V_{OUT}$	Output Voltage Accuracy	variation from nominal $V_{OUT}$	-1 <b>-2</b>		1 <b>2</b>	% %
$\Delta V_{OUT}/\Delta T$ ppm/°C	Output Voltage Temperature Coefficient	<b>Note 4</b>		<b>40</b>		
$\Delta V_{OUT}/V_{OUT}$	Line Regulation	$V_{IN} = V_{OUT} + 1V$ to 12V		0.009	0.05 <b>0.1</b>	%/V
$\Delta V_{OUT}/V_{OUT}$	Load Regulation	$I_{OUT} = 100\mu A$ to 500mA, <b>Note 5</b>		0.05	0.5 <b>0.7</b>	%
$V_{IN} - V_{OUT}$	Dropout Voltage <sup>(6)</sup>	$I_{OUT} = 100\mu A$		10	60 <b>80</b>	mV
		$I_{OUT} = 50mA$		115	175 <b>250</b>	mV
		$I_{OUT} = 150mA$		175	300 <b>400</b>	mV
		$I_{OUT} = 500mA$		350	500 <b>600</b>	mV
$I_{GND}$	Ground Pin Current <sup>(7, 8)</sup>	$V_{EN} \geq 3.0V$ , $I_{OUT} = 100\mu A$		80	130 <b>170</b>	$\mu A$
		$V_{EN} \geq 3.0V$ , $I_{OUT} = 50mA$		350	650 <b>900</b>	$\mu A$
		$V_{EN} \geq 3.0V$ , $I_{OUT} = 150mA$		1.8	2.5 <b>3.0</b>	mA
		$V_{EN} \geq 3.0V$ , $I_{OUT} = 500mA$		12	20 <b>25</b>	mA
	Ground Pin Quiescent Current <sup>(8)</sup>	$V_{EN} \leq 0.4V$		0.05	3	$\mu A$
		$V_{EN} \leq 0.18V$		0.10	<b>8</b>	$\mu A$
PSRR	Ripple Rejection	$f = 120Hz$		75		dB
$I_{LIMIT}$	Current Limit	$V_{OUT} = 0V$		700	<b>1000</b>	mA
$\Delta V_{OUT}/\Delta P_D$	Thermal Regulation	<b>Note 9</b>		<b>0.05</b>		%/W
$e_{no}$	Output Noise <sup>(10)</sup>	$I_{OUT} = 50mA$ , $C_{OUT} = 2.2\mu F$ , $C_{BYP} = 0$		500		nV/ $\sqrt{Hz}$
		$I_{OUT} = 50mA$ , $C_{OUT} = 2.2\mu F$ , $C_{BYP} = 470pF$		300		nV/ $\sqrt{Hz}$

**ENABLE Input**

$V_{ENL}$	Enable Input Logic-Low Voltage	$V_{EN} = \text{logic low (regulator shutdown)}$			0.4 <b>0.18</b>	V
		$V_{EN} = \text{logic high (regulator enabled)}$	2.0			V
$I_{ENL}$	Enable Input Current	$V_{ENL} \leq 0.4V$		0.01	-1	$\mu A$
		$V_{ENL} \leq 0.18V$		<b>0.01</b>	<b>-2</b>	<b><math>\mu A</math></b>
$I_{ENH}$		$V_{ENH} \geq 2.0V$	2	5	20 <b>25</b>	$\mu A$

**Notes:**

1. Absolute maximum ratings indicate limits beyond which damage to the component may occur. Electrical specifications do not apply when operating the device outside of its operating ratings. The maximum allowable power dissipation is a function of the maximum junction temperature,  $T_J(\text{max})$ , the junction-to-ambient thermal resistance,  $\theta_{JA}$ , and the ambient temperature,  $T_A$ . The maximum allowable power dissipation at any ambient temperature is calculated using:  $P_D(\text{max}) = (T_J(\text{max}) - T_A) \div \theta_{JA}$ . Exceeding the maximum allowable power dissipation will result in excessive die temperature, and the regulator will go into thermal shutdown. See Table 1 and the "Thermal Considerations" section for details.
2. The device is not guaranteed to function outside its operating rating.
3. Specification for packaged product only.
4. Output voltage temperature coefficient is defined as the worst case voltage change divided by the total temperature range.
5. Regulation is measured at constant junction temperature using low duty cycle pulse testing. Parts are tested for load regulation in the load range from 100 $\mu$ A to 500mA. Changes in output voltage due to heating effects are covered by the thermal regulation specification.
6. Dropout voltage is defined as the input to output differential at which the output voltage drops 2% below its nominal value measured at 1V differential.
7. Ground pin current is the regulator quiescent current plus pass transistor base current. The total current drawn from the supply is the sum of the load current plus the ground pin current.
8.  $V_{EN}$  is the voltage externally applied to devices with the EN (enable) input pin.
9. Thermal regulation is defined as the change in output voltage at a time "t" after a change in power dissipation is applied, excluding load or line regulation effects. Specifications are for a 500mA load pulse at  $V_{IN} = 12V$  for  $t = 10\text{ms}$ .
10.  $C_{BYP}$  is an optional, external bypass capacitor connected to devices with a BYP (bypass) or ADJ (adjust) pin.

# Typical Characteristics

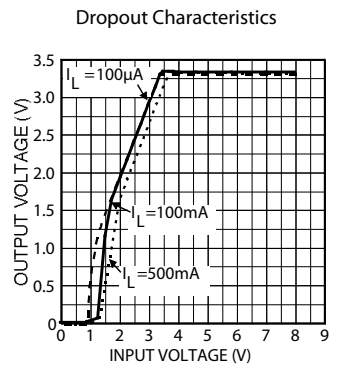
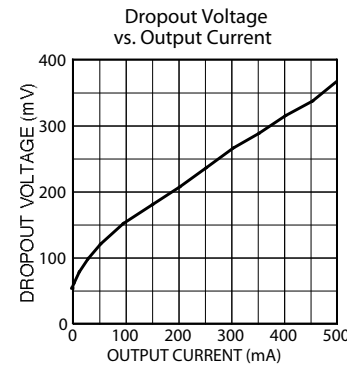
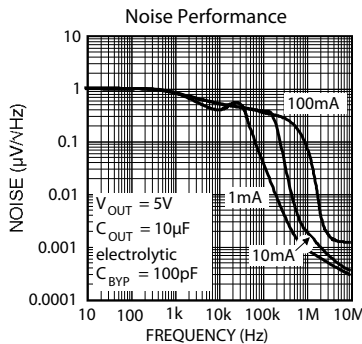
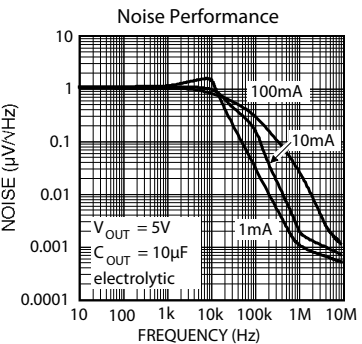
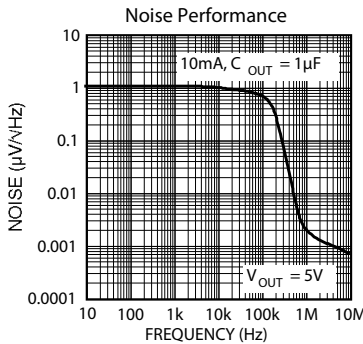
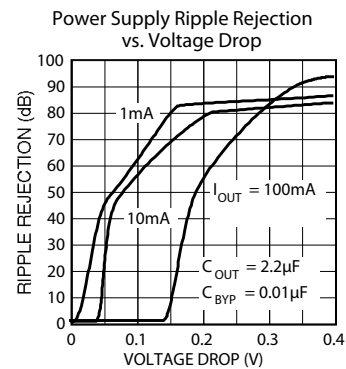
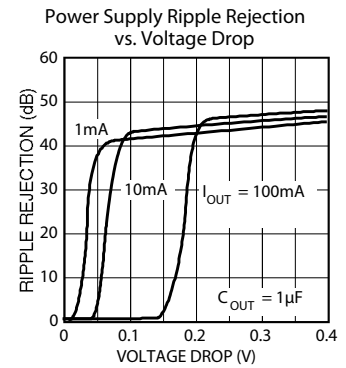
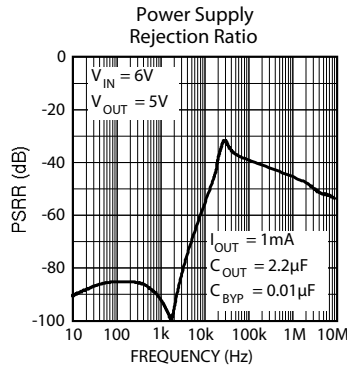
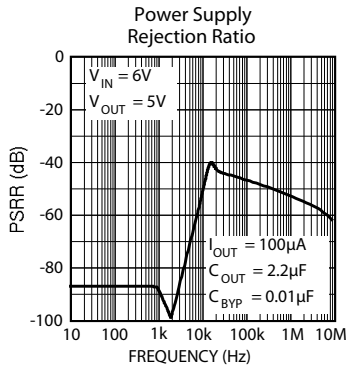
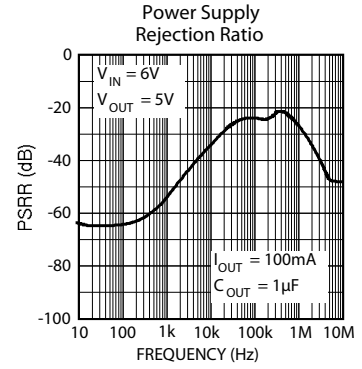
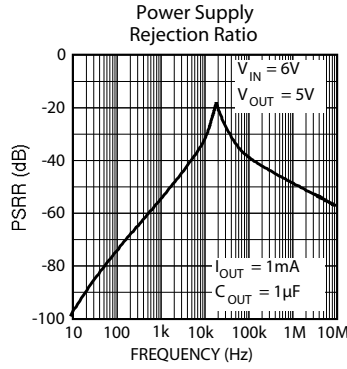
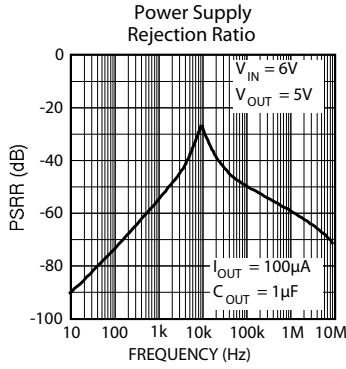

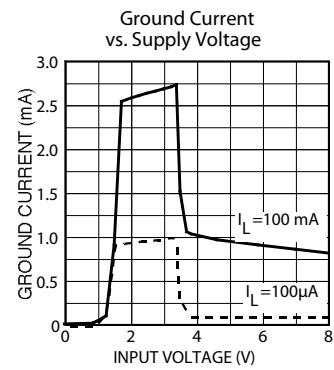
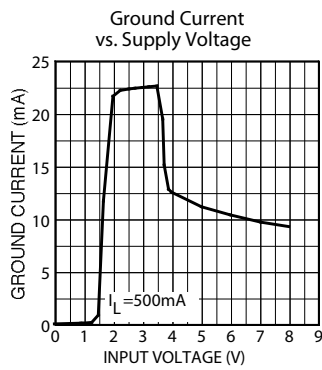
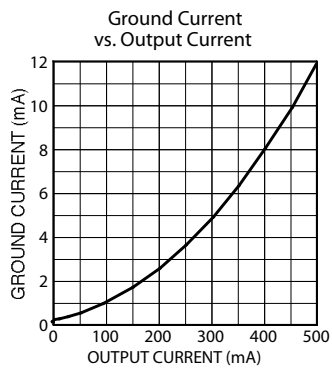

# Block Diagrams

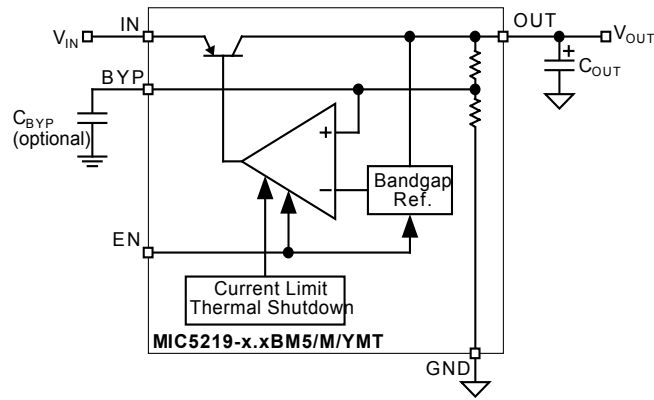

**Ultra-Low-Noise Fixed Regulator**

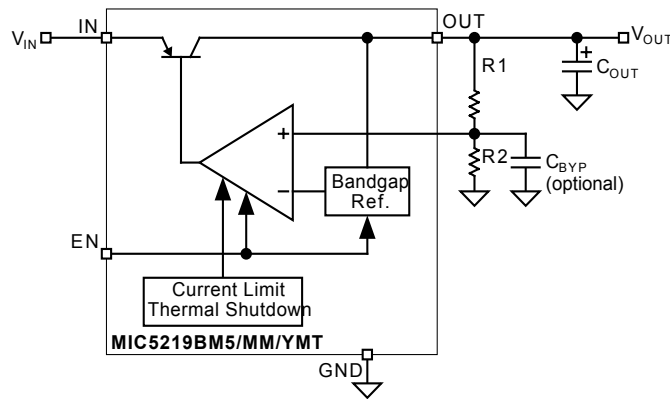

**Ultra-Low-Noise Adjustable Regulator**



## Applications Information

The MIC5219 is designed for 150mA to 200mA output current applications where a high current spike (500mA) is needed for short, start-up conditions. Basic application of the device will be discussed initially followed by a more detailed discussion of higher current applications.

### Enable/Shutdown

Forcing EN (enable/shutdown) high (>2V) enables the regulator. EN is compatible with CMOS logic. If the enable/shutdown feature is not required, connect EN to IN (supply input). See Figure 5.

### Input Capacitor

A 1 $\mu$ F capacitor should be placed from IN to GND if there is more than 10 inches of wire between the input and the AC filter capacitor or if a battery is used as the input.

### Output Capacitor

An output capacitor is required between OUT and GND to prevent oscillation. The minimum size of the output capacitor is dependent upon whether a reference bypass capacitor is used. 1 $\mu$ F minimum is recommended when C<sub>BYP</sub> is not used (see Figure 5). 2.2 $\mu$ F minimum is recommended when C<sub>BYP</sub> is 470pF (see Figure 6). For applications <3V, the output capacitor should be increased to 22 $\mu$ F minimum to reduce start-up overshoot. Larger values improve the regulator's transient response. The output capacitor value may be increased without limit.

The output capacitor should have an ESR (equivalent series resistance) of about 1 $\Omega$  or less and a resonant frequency above 1MHz. Ultra-low-ESR capacitors could cause oscillation and/or underdamped transient response. Most tantalum or aluminum electrolytic capacitors are adequate; film types will work, but are more expensive. Many aluminum electrolytics have electrolytes that freeze at about -30°C, so solid tantalums are recommended for operation below -25°C.

At lower values of output current, less output capacitance is needed for stability. The capacitor can be reduced to 0.47 $\mu$ F for current below 10mA, or 0.33 $\mu$ F for currents below 1mA.

### No-Load Stability

The MIC5219 will remain stable and in regulation with no load (other than the internal voltage divider) unlike many other voltage regulators. This is especially important in CMOS RAM keep-alive applications.

### Reference Bypass Capacitor

BYP is connected to the internal voltage reference. A 470pF capacitor (C<sub>BYP</sub>) connected from BYP to GND quiets this reference, providing a significant reduction in output noise (ultra-low-noise performance). C<sub>BYP</sub> reduces the regulator phase margin; when using C<sub>BYP</sub>, output capacitors of 2.2 $\mu$ F or greater are generally required to maintain stability.

The start-up speed of the MIC5219 is inversely proportional to the size of the reference bypass capacitor. Applications requiring a slow ramp-up of output voltage should consider larger values of C<sub>BYP</sub>. Likewise, if rapid turn-on is necessary, consider omitting C<sub>BYP</sub>.

## Thermal Considerations

The MIC5219 is designed to provide 200mA of continuous current in two very small profile packages. Maximum power dissipation can be calculated based on the output current and the voltage drop across the part. To determine the maximum power dissipation of the package, use the thermal resistance, junction-to-ambient, of the device and the following basic equation.

$$P_D(\max) = \frac{(T_J(\max) - T_A)}{\theta_{JA}}$$

T<sub>J</sub>(max) is the maximum junction temperature of the die, 125°C, and T<sub>A</sub> is the ambient operating temperature.  $\theta_{JA}$  is layout dependent; Table 1 shows examples of thermal resistance, junction-to-ambient, for the MIC5219.

Package	$\theta_{JA}$ Recommended Minimum Footprint	$\theta_{JA}$ 1" Square 2oz. Copper	$\theta_{JC}$
MM8 <sup>®</sup> (MM)	160°C/W	70°C/W	30°C/W
SOT-23-5 (M5)	220°C/W	170°C/W	130°C/W
2x2 MLF <sup>®</sup> (ML)	90°C/W	—	—
2x2 Thin MLF <sup>®</sup> (MT)	90°C/W	—	—

**Table 1. MIC5219 Thermal Resistance**

The actual power dissipation of the regulator circuit can be determined using one simple equation.

$$P_D = (V_{IN} - V_{OUT}) I_{OUT} + V_{IN} I_{GND}$$

Substituting P<sub>D</sub>(max) for P<sub>D</sub> and solving for the operating conditions that are critical to the application will give the maximum operating conditions for the regulator circuit. For example, if we are operating the MIC5219-3.3BM5 at room temperature, with a minimum footprint layout, we can determine the maximum input voltage for a set output current.

$$P_D(\max) = \frac{(125^\circ\text{C} - 25^\circ\text{C})}{220^\circ\text{C} / \text{W}}$$

$$P_D(\max) = 455\text{mW}$$

The thermal resistance, junction-to-ambient, for the minimum footprint is 220°C/W, taken from Table 1. The maximum power dissipation number cannot be exceeded for proper operation of the device. Using the output voltage of 3.3V, and an output current of 150mA, we can determine the maximum input voltage. Ground current, maximum of 3mA for 150mA of output current, can be taken from the "Electrical Characteristics" section of the data sheet.

$$455\text{mW} = (V_{IN} - 3.3\text{V}) \times 150\text{mA} + V_{IN} \times 3\text{mA}$$

$$455\text{mW} = (150\text{mA}) \times V_{IN} + 3\text{mA} \times V_{IN} - 495\text{mW}$$

$$950\text{mW} = 153\text{mA} \times V_{IN}$$

$$V_{IN} = 6.2V_{MAX}$$

Therefore, a 3.3V application at 150mA of output current can accept a maximum input voltage of 6.2V in a SOT-23-5 package. For a full discussion of heat sinking and thermal effects on voltage regulators, refer to the "Regulator Thermals" section of Micrel's Designing with Low-Dropout Voltage Regulators handbook.

## Peak Current Applications

The MIC5219 is designed for applications where high start-up currents are demanded from space constrained regulators. This device will deliver 500mA start-up current from a SOT-23-5 or MM8 package, allowing high power from a very low profile device. The MIC5219 can subsequently provide output current that is only limited by the thermal characteristics of the device. You can obtain higher continuous currents from the device with the proper design. This is easily proved with some thermal calculations.

If we look at a specific example, it may be easier to follow. The MIC5219 can be used to provide up to 500mA continuous output current. First, calculate the maximum power dissipation of the device, as was done in the thermal considerations section. Worst case thermal resistance ( $\theta_{JA} = 220^{\circ}\text{C}/\text{W}$  for the MIC5219-x.xBM5), will be used for this example.

$$P_D(\text{max}) = \frac{(T_J(\text{max}) - T_A)}{\theta_{JA}}$$

Assuming a 25°C room temperature, we have a maximum power dissipation number of

$$P_D(\text{max}) = \frac{(125^{\circ}\text{C} - 25^{\circ}\text{C})}{220^{\circ}\text{C} / \text{W}}$$

$$P_D(\text{max}) = 455\text{mW}$$

Then we can determine the maximum input voltage for a 5-volt regulator operating at 500mA, using worst case ground current.

$$P_D(\text{max}) = 455\text{mW} = (V_{IN} - V_{OUT}) I_{OUT} + V_{IN} I_{GND}$$

$$I_{OUT} = 500\text{mA}$$

$$V_{OUT} = 5\text{V}$$

$$I_{GND} = 20\text{mA}$$

$$455\text{mW} = (V_{IN} - 5\text{V}) 500\text{mA} + V_{IN} \times 20\text{mA}$$

$$2.995\text{W} = 520\text{mA} \times V_{IN}$$

$$V_{IN}(\text{max}) = \frac{2.995\text{W}}{520\text{mA}} = 5.683\text{V}$$

Therefore, to be able to obtain a constant 500mA output current from the 5219-5.0BM5 at room temperature, you need extremely tight input-output voltage differential, barely above the maximum dropout voltage for that current rating.

You can run the part from larger supply voltages if the proper precautions are taken. Varying the duty cycle using the enable pin can increase the power dissipation of the device by maintaining a lower average power figure. This is ideal for applications where high current is only needed in short bursts. Figure 1 shows the safe operating regions for the MIC5219-x.xBM5 at three different ambient temperatures and at different output currents. The data used to determine this figure assumed a minimum footprint PCB design for minimum heat sinking. Figure 2 incorporates the same factors as the first figure, but assumes a much better heat sink. A 1" square copper trace on the PC board reduces the thermal resistance of the device. This improved thermal resistance improves power dissipation and allows for a larger safe operating region.

Figures 3 and 4 show safe operating regions for the MIC5219-x.

xBMM, the power MSOP package part. These graphs show three typical operating regions at different temperatures. The lower the temperature, the larger the operating region. The graphs were obtained in a similar way to the graphs for the MIC5219-x.xBM5, taking all factors into consideration and using two different board layouts, minimum footprint and 1" square copper PC board heat sink. (For further discussion of PC board heat sink characteristics, refer to "Application Hint 17, Designing PC Board Heat Sinks".)

The information used to determine the safe operating regions can be obtained in a similar manner such as determining typical power dissipation, already discussed. Determining the maximum power dissipation based on the layout is the first step, this is done in the same manner as in the previous two sections. Then, a larger power dissipation number multiplied by a set maximum duty cycle would give that maximum power dissipation number for the layout. This is best shown through an example. If the application calls for 5V at 500mA for short pulses, but the only supply voltage available is 8V, then the duty cycle has to be adjusted to determine an average power that does not exceed the maximum power dissipation for the layout.

$$\text{Avg. } P_D = \left( \frac{\% \text{ DC}}{100} \right) (V_{IN} - V_{OUT}) I_{OUT} + V_{IN} I_{GND}$$

$$455\text{mW} = \left( \frac{\% \text{ DC}}{100} \right) (8\text{V} - 5\text{V}) 500\text{mA} + 8\text{V} \times 20\text{mA}$$

$$455\text{mW} = \left( \frac{\% \text{ Duty Cycle}}{100} \right) 1.66\text{W}$$

$$0.274 = \frac{\% \text{ Duty Cycle}}{100}$$

$$\% \text{ Duty Cycle Max} = 27.4\%$$

With an output current of 500mA and a three-volt drop across the MIC5219-xxBMM, the maximum duty cycle is 27.4%.

Applications also call for a set nominal current output with a greater amount of current needed for short durations. This is a tricky situation, but it is easily remedied. Calculate the average power dissipation for each current section, then add the two numbers giving the total power dissipation for the regulator. For example, if the regulator is operating normally at 50mA, but for 12.5% of the time it operates at 500mA output, the total power dissipation of the part can be easily determined. First, calculate the power dissipation of the device at 50mA. We will use the MIC5219-3.3BM5 with 5V input voltage as our example.

$$P_D \times 50\text{mA} = (5\text{V} - 3.3\text{V}) \times 50\text{mA} + 5\text{V} \times 650\mu\text{A}$$

$$P_D \times 50\text{mA} = 173\text{mW}$$

However, this is continuous power dissipation, the actual on-time for the device at 50mA is (100%-12.5%) or 87.5% of the time, or 87.5% duty cycle. Therefore,  $P_D$  must be multiplied by the duty cycle to obtain the actual average power dissipation at 50mA.

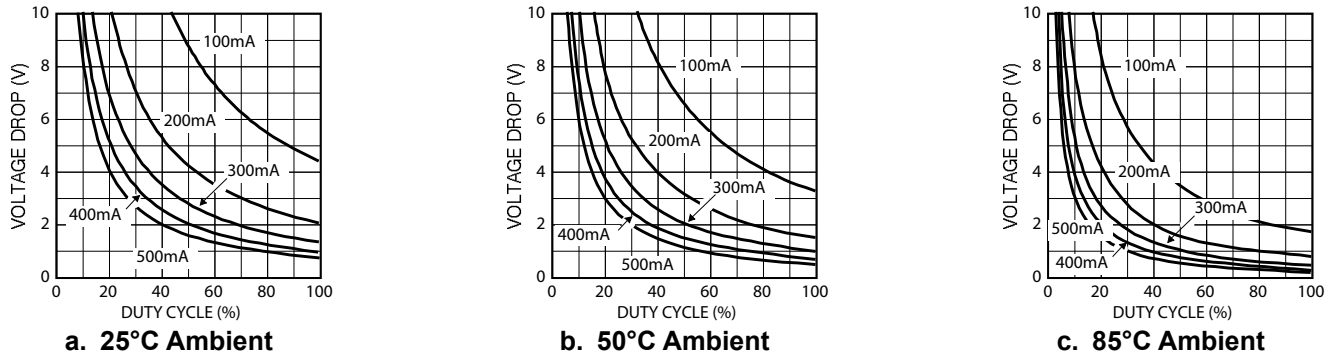

**Figure 1. MIC5219-x.xBM5 (SOT-23-5) on Minimum Recommended Footprint**

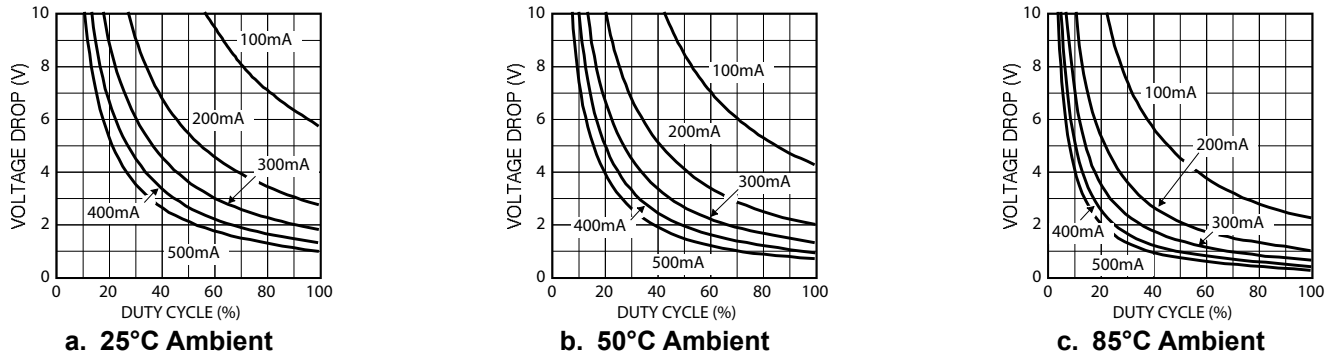

**Figure 2. MIC5219-x.xBM5 (SOT-23-5) on 1-inch<sup>2</sup> Copper Cladding**

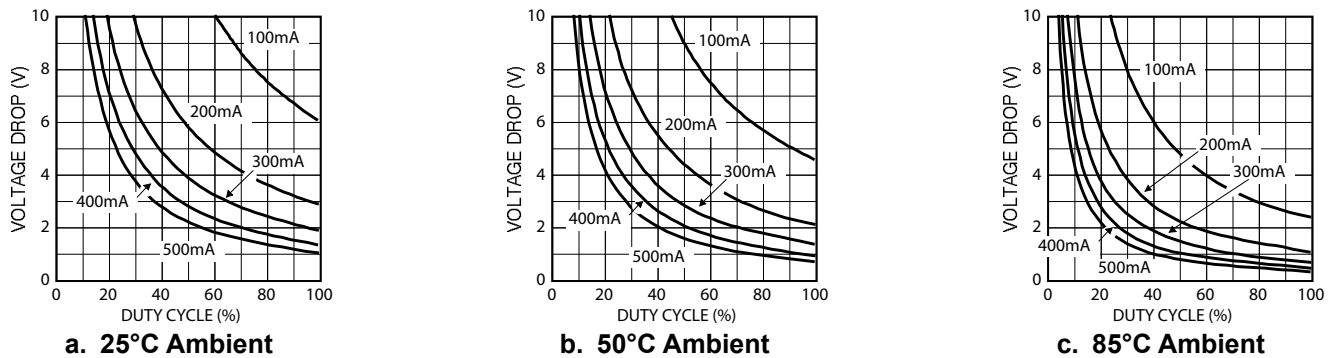

**Figure 3. MIC5219-x.xBMM (MSOP-8) on Minimum Recommended Footprint**

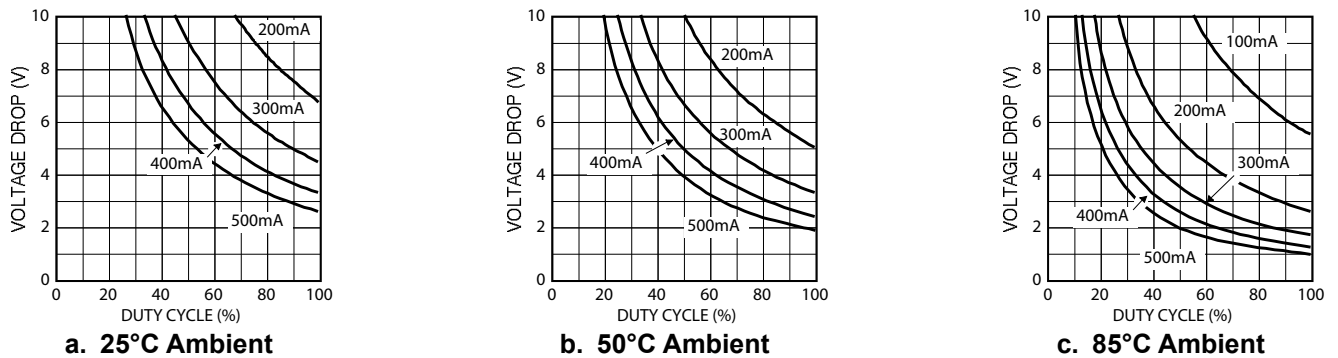

**Figure 4. MIC5219-x.xBMM (MSOP-8) on 1-inch<sup>2</sup> Copper Cladding**

$$P_D \times 50\text{mA} = 0.875 \times 173\text{mW}$$

$$P_D \times 50\text{mA} = 151\text{mW}$$

The power dissipation at 500mA must also be calculated.

$$P_D \times 500\text{mA} = (5\text{V} - 3.3\text{V}) 500\text{mA} + 5\text{V} \times 20\text{mA}$$

$$P_D \times 500\text{mA} = 950\text{mW}$$

This number must be multiplied by the duty cycle at which it would be operating, 12.5%.

$$P_D \times = 0.125 \times 950\text{mW}$$

$$P_D \times = 119\text{mW}$$

The total power dissipation of the device under these conditions is the sum of the two power dissipation figures.

$$P_{D(\text{total})} = P_D \times 50\text{mA} + P_D \times 500\text{mA}$$

$$P_{D(\text{total})} = 151\text{mW} + 119\text{mW}$$

$$P_{D(\text{total})} = 270\text{mW}$$

The total power dissipation of the regulator is less than the maximum power dissipation of the SOT-23-5 package at room temperature, on a minimum footprint board and therefore would operate properly.

Multilayer boards with a ground plane, wide traces near the pads, and large supply-bus lines will have better thermal conductivity.

For additional heat sink characteristics, please refer to Micrel "Application Hint 17, Designing P.C. Board Heat Sinks", included in Micrel's Databook. For a full discussion of heat sinking and thermal effects on voltage regulators, refer to "Regulator Thermals" section of Micrel's [Designing with Low-Dropout Voltage Regulators](#) handbook.

**Fixed Regulator Circuits**

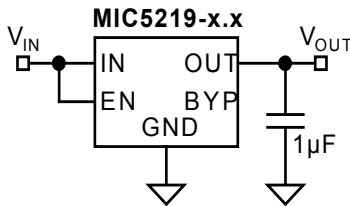

**Figure 5. Low-Noise Fixed Voltage Regulator**

Figure 5 shows a basic MIC5219-x.xBMX fixed-voltage regulator circuit. A 1µF minimum output capacitor is required for basic fixed-voltage applications.

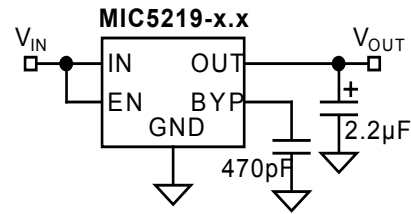

**Figure 6. Ultra-Low-Noise Fixed Voltage Regulator**

Figure 6 includes the optional 470pF noise bypass capacitor between BYP and GND to reduce output noise. Note that the minimum value of C<sub>OUT</sub> must be increased when the bypass capacitor is used.

**Adjustable Regulator Circuits**

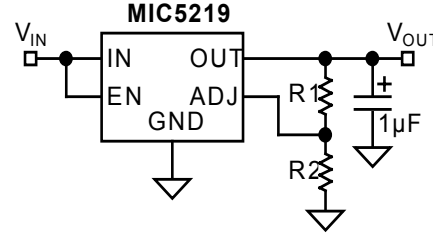
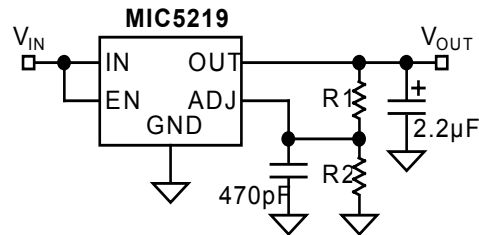

**Figure 7. Low-Noise Adjustable Voltage Regulator**

Figure 7 shows the basic circuit for the MIC5219 adjustable regulator. The output voltage is configured by selecting values for R1 and R2 using the following formula:

$$V_{OUT} = 1.242\text{V} \left( \frac{R2}{R1} + 1 \right)$$

Although ADJ is a high-impedance input, for best performance, R2 should not exceed 470kΩ.



**Figure 8. Ultra-Low-Noise Adjustable Application**

Figure 8 includes the optional 470pF bypass capacitor from ADJ to GND to reduce output noise.

# Package Information

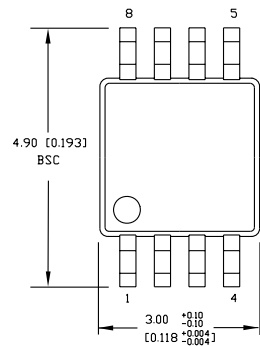

TOP VIEW

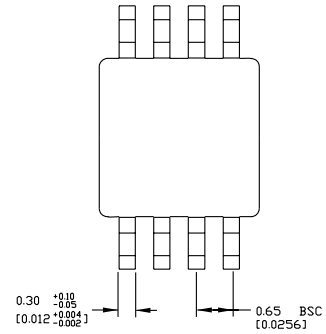

BOTTOM VIEW

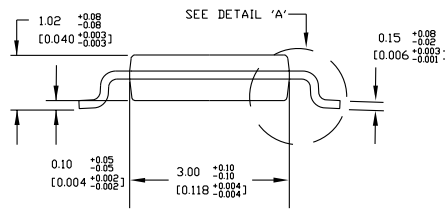

SIDE VIEW

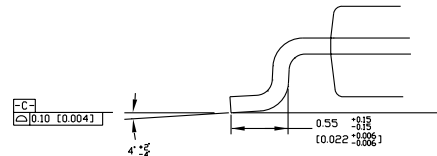

DETAIL A

**NOTES:**

1. DIMENSIONS ARE IN MM [INCHES].
2. CONTROLLING DIMENSION: MM
3. DIMENSION DOES NOT INCLUDE MOLD FLASH OR PROTRUSIONS, EITHER OF WHICH SHALL NOT EXCEED 0.20 [0.008] PER SIDE.

## 8-Pin MSOP (MM)

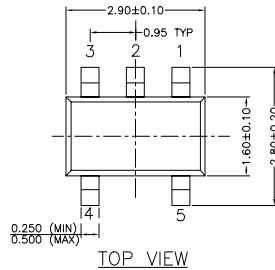

TOP VIEW

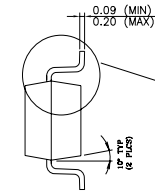

END VIEW

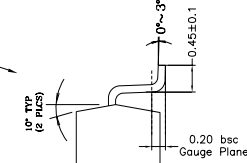

DETAIL

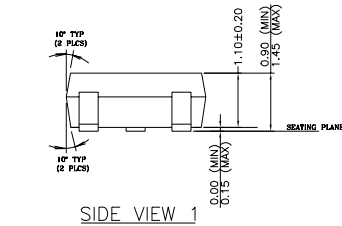

SIDE VIEW 1

**NOTE:**

1. PACKAGE OUTLINE EXCLUSIVE OF MOLD FLASH & BURR.
2. PACKAGE OUTLINE INCLUSIVE OF SOLER PLATING.
3. DIMENSION AND TOLERANCE PER ANSI Y14.5M, 1982.
4. FOOT LENGTH MEASUREMENT BASED ON GAUGE PLANE METHOD.
5. DIE FACES UP FOR MOLD, AND FACES DOWN FOR TRIM/FORM.
6. ALL DIMENSIONS ARE IN MILLIMETERS.

## SOT-23-5 (M5)

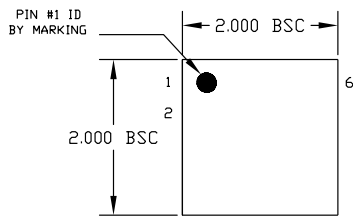

TOP VIEW

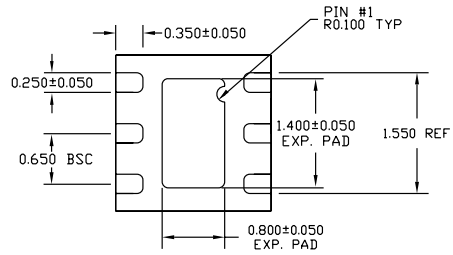

BOTTOM VIEW

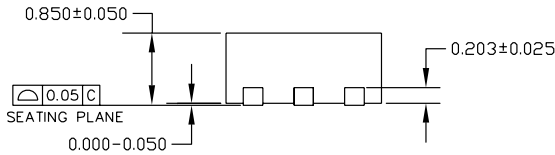

SIDE VIEW

- NOTE:
1. ALL DIMENSIONS ARE IN MILLIMETERS.
  2. MAX. PACKAGE WARPAGE IS 0.05 mm.
  3. MAXIMUM ALLOWABLE BURRS IS 0.076 mm IN ALL DIRECTIONS.
  4. PIN #1 ID ON TOP WILL BE LASER MARKED.

**6-Pin MLF® (ML)**

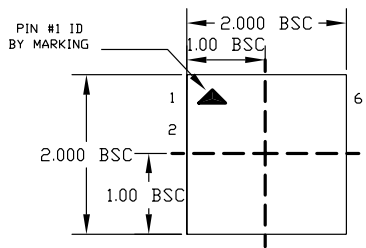

TOP VIEW

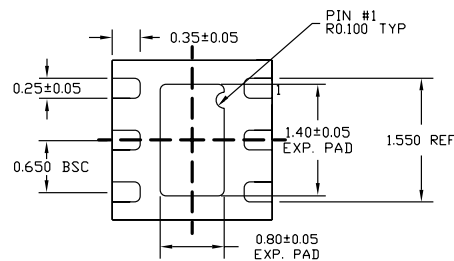

BOTTOM VIEW

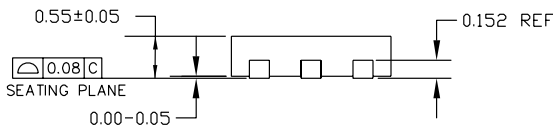

SIDE VIEW

- NOTE:
1. ALL DIMENSIONS ARE IN MILLIMETERS.
  2. MAX. PACKAGE WARPAGE IS 0.08 mm.
  3. MAXIMUM ALLOWABLE BURRS IS 0.076 mm IN ALL DIRECTIONS.
  4. PIN #1 ID ON TOP WILL BE LASER MARKED.

**6-Pin Thin MLF® (MT)**

**MICREL, INC. 2180 FORTUNE DRIVE SAN JOSE, CA 95131 USA**

**TEL + 1 (408) 944-0800 FAX + 1 (408) 474-1000 WEB <http://www.micrel.com>**

The information furnished by Micrel in this data sheet is believed to be accurate and reliable. However, no responsibility is assumed by Micrel for its use. Micrel reserves the right to change circuitry and specifications at any time without notification to the customer.

Micrel Products are not designed or authorized for use as components in life support appliances, devices or systems where malfunction of a product can reasonably be expected to result in personal injury. Life support devices or systems are devices or systems that (a) are intended for surgical implant into the body or (b) support or sustain life, and whose failure to perform can be reasonably expected to result in a significant injury to the user. A Purchaser's use or sale of Micrel Products for use in life support appliances, devices or systems is at Purchaser's own risk and Purchaser agrees to fully indemnify

Micrel for any damages resulting from such use or sale.

© 2005 Micrel, Incorporated.

[www.s-manuals.com](http://www.s-manuals.com)