

Surface Mount Fast Switching Diodes

MMBD4448DW

FEATURES

- Fast switching speed.
- For general purpose switching application.
- Ultra-small surface mount package.
- High conductance.



Lead-free

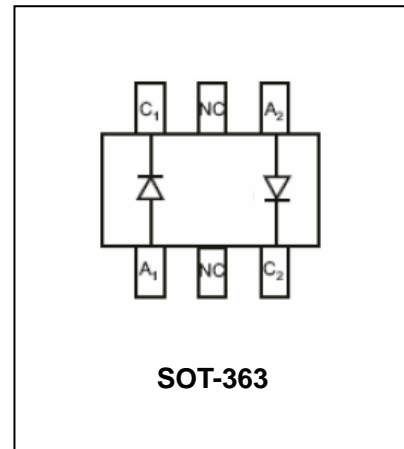

APPLICATIONS

- For general purpose switching application.

ORDERING INFORMATION

Type No.	Marking	Package Code
MMBD4448DW	KA3	SOT-363

MAXIMUM RATING @ Ta=25°C unless otherwise specified

Symbol	Characteristic	Value	Unit
V_{RM}	Non-repetitive peak reverse Voltage	100	V
V_{RRM}	Peak repetitive reverse Voltage	75	V
V_{RWM}	Working peak reverse voltage		
V_R	DC reverse voltage		
$V_{R(RMS)}$	RMS Reverse voltage	53	V
I_{FM}	Forward continuous current	500	mA
I_O	Average rectified output current	250	mA
I_{FSM}	Non-Repetitive peak forward surge current	4	A
	@t<1.0μs	2	
P_D	Power Dissipation	200	mW
$R_{\theta JA}$	Thermal Resistance, Junction to Ambient	625	°C/W
T_j, T_{stg}	Junction and Storage Temperature	-65 to+150	°C

Surface Mount Fast Switching Diodes

MMBD4448DW

ELECTRICAL CHARACTERISTICS @ Ta=25°C unless otherwise specified

Parameter	Symbol	Test conditions	MIN	MAX	UNIT
Reverse breakdown voltage	$V_{(BR)R}$	$I_R=10\mu A$	75		V
Forward voltage	V_F	$I_F=5.0mA$ $I_F=10mA$ $I_F=50mA$ $I_F=150mA$	0.62	0.720 0.855 1.0 1.25	V
Reverse current	I_R	$V_R=75V$ $V_R=75V, T_j=150^\circ C$ $V_R=25V, T_j=150^\circ C$ $V_R=20V$		2.5 50 30 25	μA μA μA nA
Total Capacitance	C_T	$V_{CB}=10V, f=1.0MHz, I_E=0$		4.0	pF
Reverse Recovery time	t_{rr}	$I_F=I_R=10mA, I_{rr}=0.1*I_R, R_L=100\Omega$		4.0	ns

TYPICAL CHARACTERISTICS @ Ta=25°C unless otherwise specified

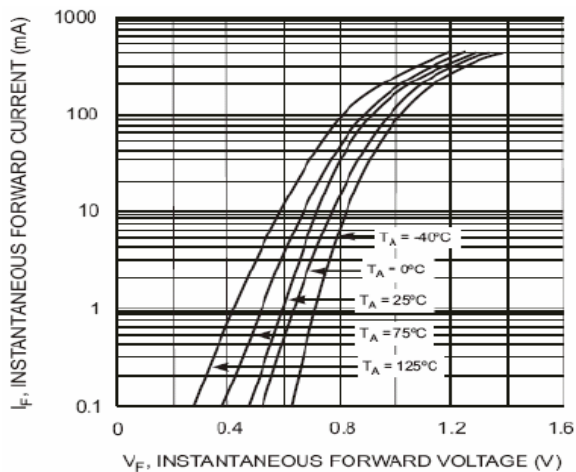

Fig. 1 Typical Forward Characteristics

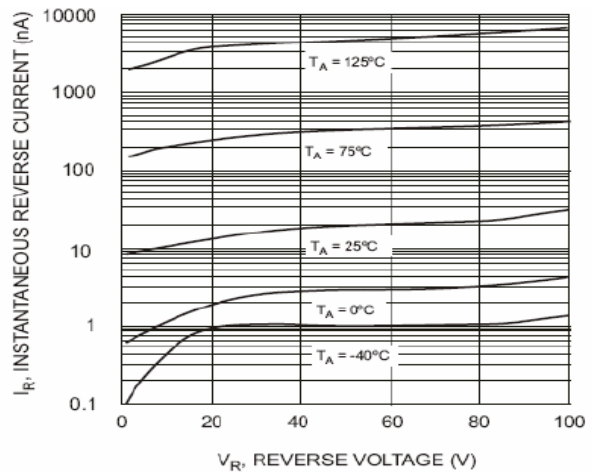

Fig. 2 Typical Reverse Characteristics

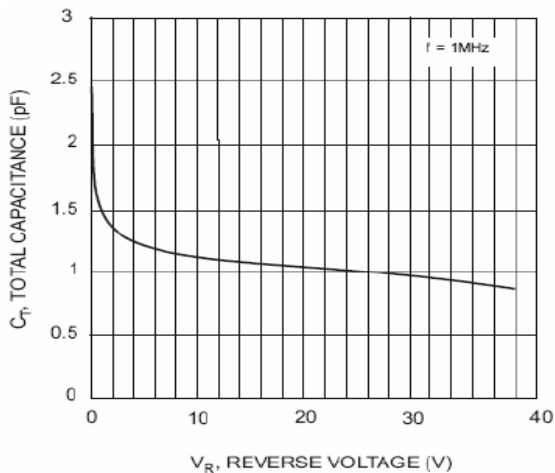

Fig. 3 Typical Total Capacitance vs. Reverse Voltage

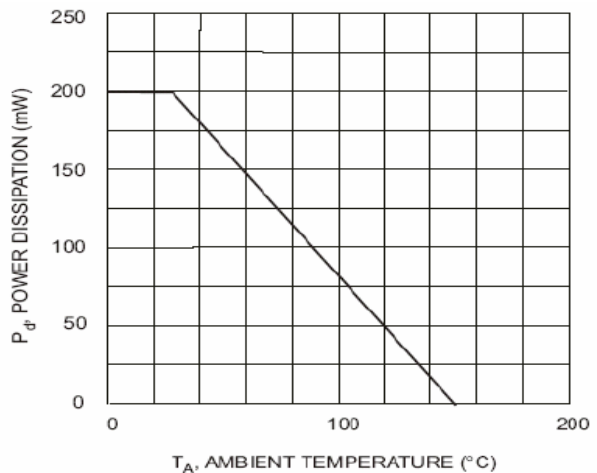

Fig. 4 Power Derating Curve, Total Package

Surface Mount Fast Switching Diodes

MMBD4448DW

PACKAGE OUTLINE

Plastic surface mounted package

SOT-363

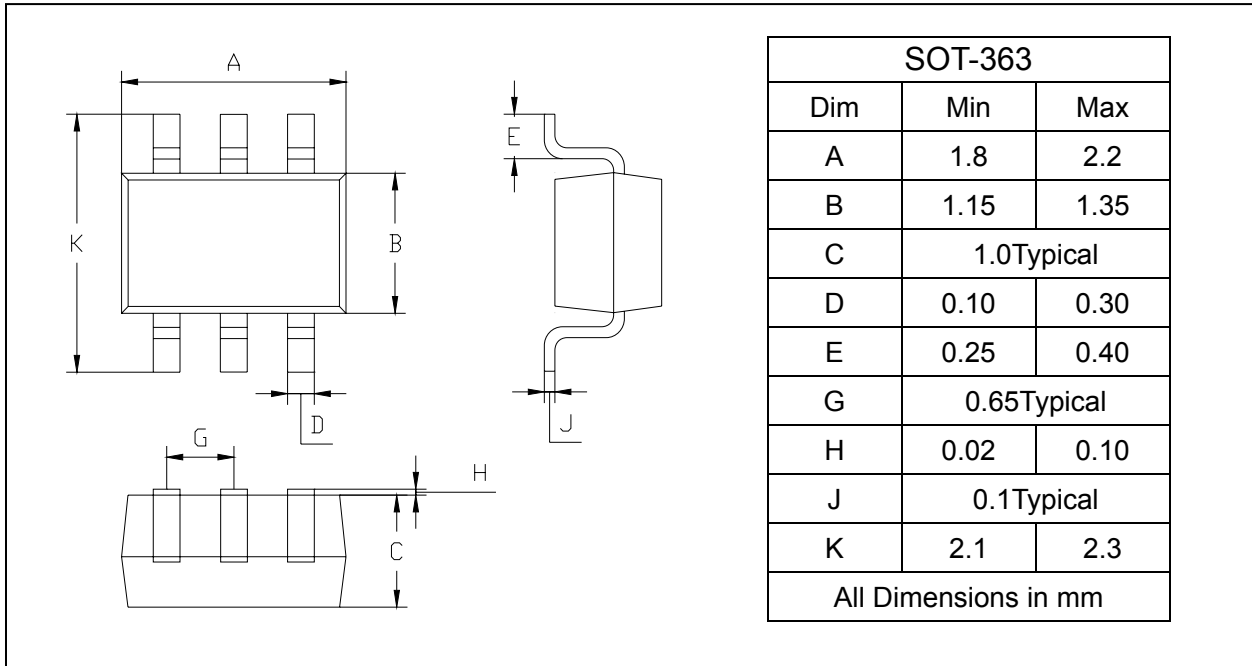

SOLDERING FOOTPRINT

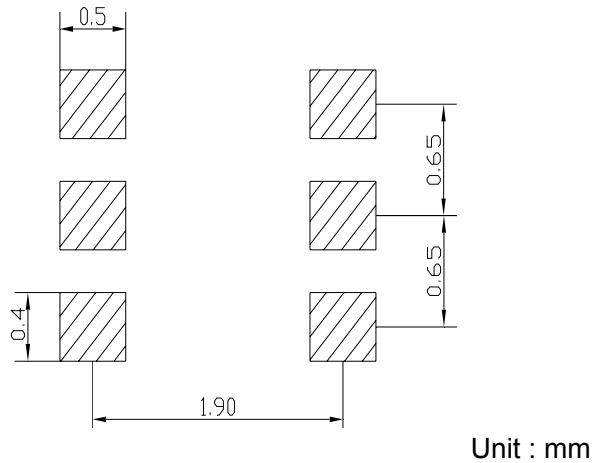

PACKAGE INFORMATION

Device	Package	Shipping
MMBD4448DW	SOT-363	3000/Tape&Reel

www.s-manuals.com