

Surface Mount Fast Switching Diodes

MMBD4448HCQW/AQW/ADW/CDW/SDW/TW

FEATURES

- High conductance.
- Fast switching speed.
- Ultra-small surface mount package.
- For general purpose switching application.

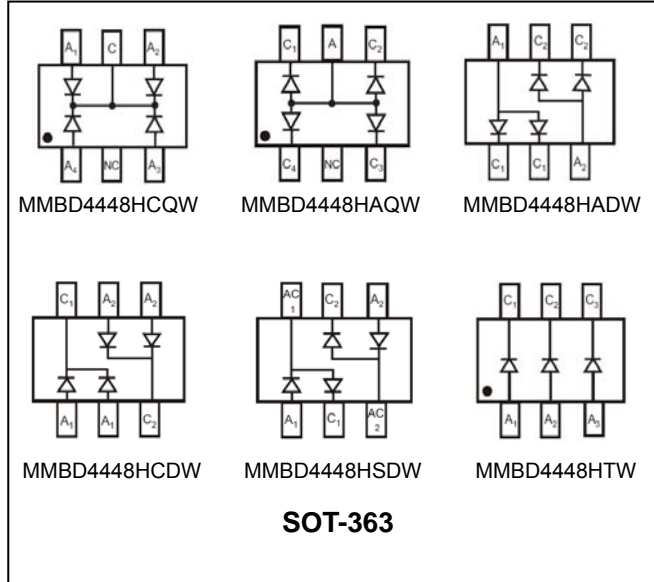

APPLICATIONS

- High speed switching application.

ORDERING INFORMATION

Type No.	Marking	Package Code
MMBD4448HCQW	KA4	SOT-363
MMBD4448HAQW	KA5	SOT-363
MMBD4448HADW	KA6	SOT-363
MMBD4448HCDW	KA7	SOT-363
MMBD4448HSDW	KAB	SOT-363
MMBD4448HTW	KAA	SOT-363

MAXIMUM RATING @ Ta=25°C unless otherwise specified

Symbol	Characteristic	Value	Unit
V_{RM}	Non-Repetitive peak reverse voltage	100	V
V_{RRM}	Repetitive peak reverse Voltage	80	V
V_{RWM}	Working peak reverse voltage		
V_R	DC reverse voltage		
$V_{R(RMS)}$	RMS Reverse voltage	57	V
I_{FM}	Forward continuous current	500	mA
I_O	Average rectified output current	250	mA
I_{FSM}	Forward surge current	@t=1.0μs	4.0
		@t=1.0s	2.0
P_D	Power Dissipation	200	mW
$R_{θJA}$	Thermal resistance, Junction to ambient air	625	°C/W
T_j, T_{stg}	Junction and Storage Temperature	-65 to +150	°C

Surface Mount Fast Switching Diodes

MMBD4448HCQW/AQW/ADW/CDW/SDW/TW

ELECTRICAL CHARACTERISTICS @ Ta=25°C unless otherwise specified

Parameter	Symbol	Test conditions	MIN	MAX	UNIT
Reverse breakdown voltage	$V_{(BR)R}$	$I_R=100\mu A$	80	-	V
Average reverse current	I_R	$V_R=70V$	-	100	nA
		$V_R=75V, T_j=150^\circ C$	-	50	μA
		$V_R=25V, T_j=150^\circ C$	-	30	μA
		$V_R=20V$	-	25	nA
Forward voltage	V_F	$I_F=5.0mA$	0.62	0.72	V
		$I_F=10mA$	-	0.855	
		$I_F=100mA$	-	1.0	
		$I_F=150mA$	-	1.25	
Total Capacitance	C_T	$V_R=6V, f=1.0MHz$	-	3.5	pF
Reverse Recovery time	t_{rr}	$I_F=5mA, V_R=6V$	-	4.0	ns

TYPICAL CHARACTERISTICS @ Ta=25°C unless otherwise specified

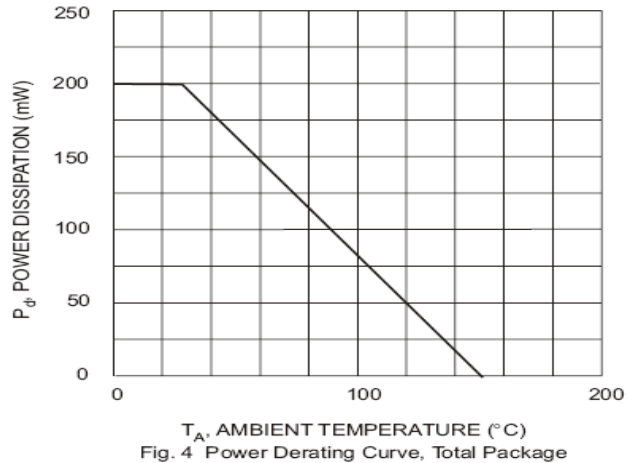
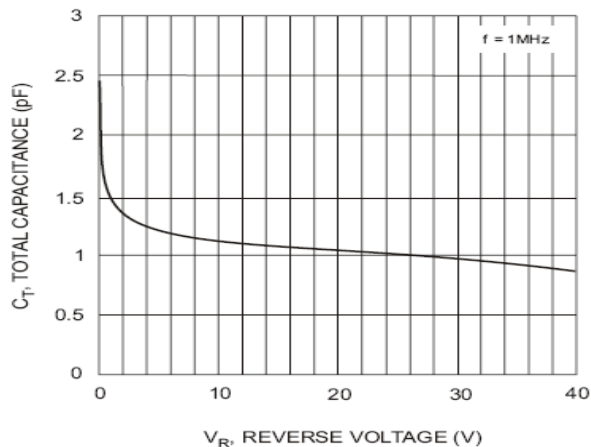
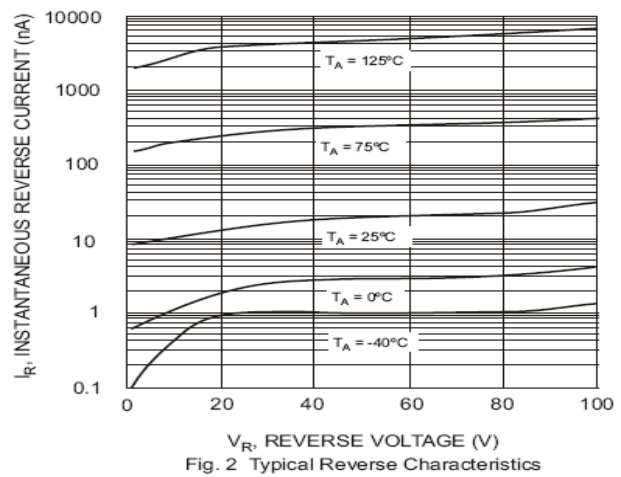
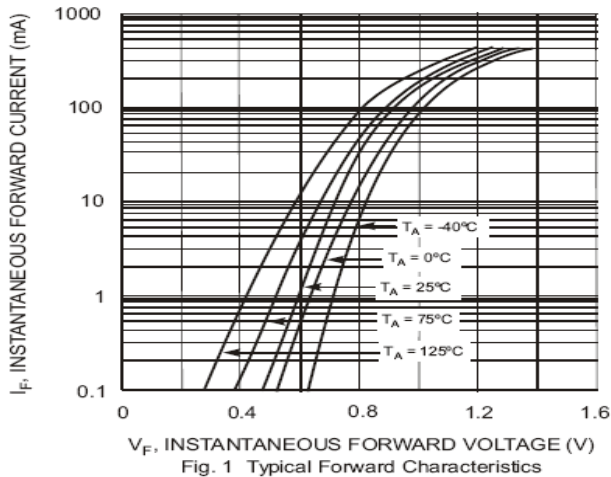

Surface Mount Fast Switching Diodes

MMBD4448HCQW/AQW/ADW/CDW/SDW/TW

PACKAGE OUTLINE

Plastic surface mounted package

SOT-363

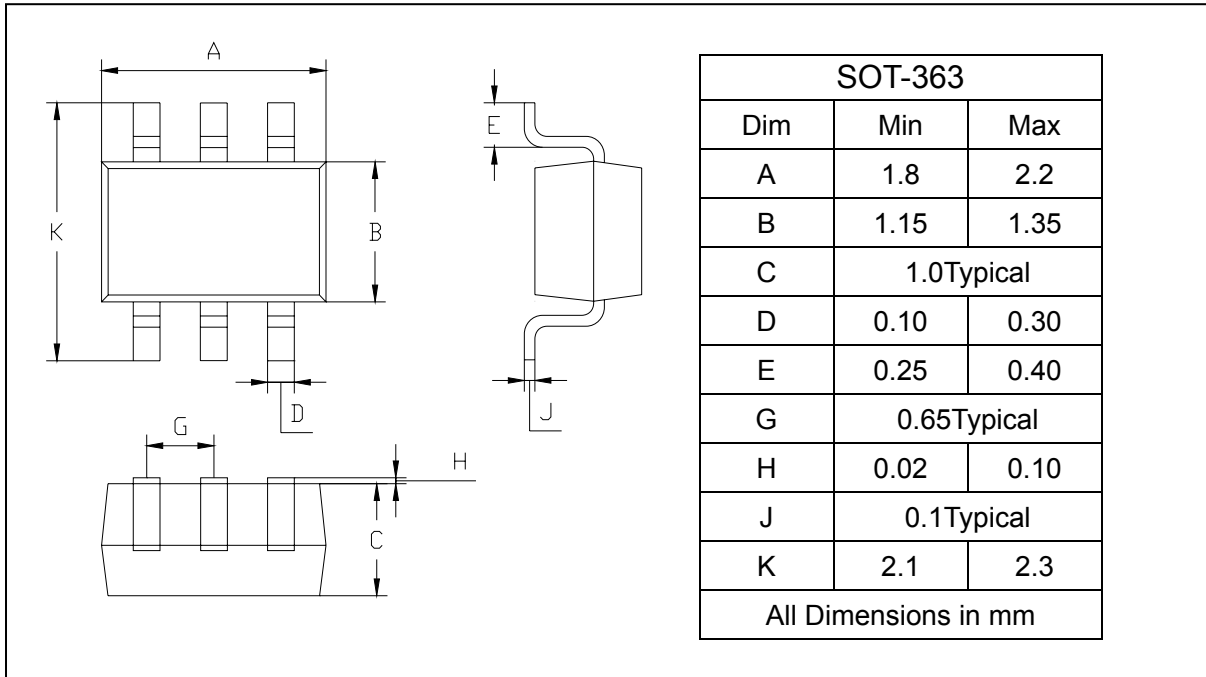

SOLDERING FOOTPRINT

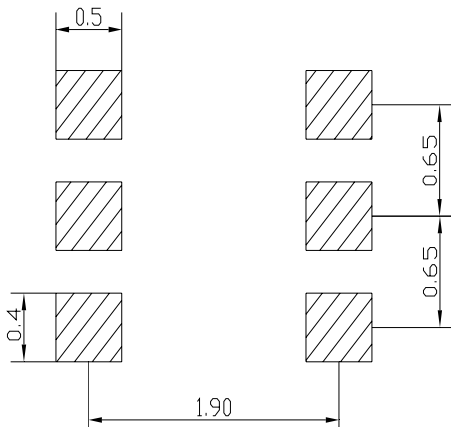

Unit : mm

PACKAGE INFORMATION

Device	Package	Shipping
MMBD4448HCQW/AQW/ADW/CDW/SDW/TW	SOT-363	3000/Tape&Reel

www.s-manuals.com