

NUP5150MU

5-Line Transient Voltage Suppressor Array

This 5-line transient voltage suppressor array is designed for applications requiring transient voltage protection capability. It is intended for use in over-transient voltage and ESD sensitive equipment such as cell phones, portables, computers, printers and other applications. This device features a monolithic common anode design which protects five independent lines in a single UDFN package. This device is ideal for situations where board space is at a premium.

Features

- Protects up to 5 Lines in a Single UDFN Package
- ESD Rating of Class 3B (Exceeding 8 kV) per Human Body Model
- Compliance with IEC 61000-4-2
- This is a Pb-Free Device

Applications

- Hand Held Portable Applications
- Serial and Parallel Ports
- Notebooks, Desktops, Servers

MAXIMUM RATINGS (T_J = 25°C, unless otherwise specified)

Symbol	Rating	Value	Unit
T _J	Operating Junction Temperature Range	-40 to 125	°C
T _{STG}	Storage Temperature Range	-55 to 150	°C
T _L	Lead Solder Temperature — Maximum (10 seconds)	260	°C
ESD	Human Body Model (HBM) IEC 61000-4-2 Contact (ESD)	16000 8000	V

Stresses exceeding Maximum Ratings may damage the device. Maximum Ratings are stress ratings only. Functional operation above the Recommended Operating Conditions is not implied. Extended exposure to stresses above the Recommended Operating Conditions may affect device reliability.



ON Semiconductor®

<http://onsemi.com>

UDFN6 5-LINE TRANSIENT VOLTAGE SUPPRESSOR

PIN ASSIGNMENT

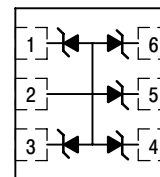

- PIN 1. CATHODE
- 2. ANODE
- 3. CATHODE
- 4. CATHODE
- 5. CATHODE
- 6. CATHODE

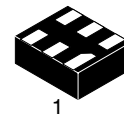

MARKING DIAGRAM

UDFN6
CASE 517AA



- 5 = Specific Device Code
- M = Month Code
- = Pb-Free Package

*Specific Device Code orientation may vary depending upon manufacturing location.

ORDERING INFORMATION

Device	Package	Shipping [†]
NUP5150MUTBG	UDFN6 (Pb-Free)	3000/Tape & Reel

[†]For information on tape and reel specifications, including part orientation and tape sizes, please refer to our Tape and Reel Packaging Specification Brochure, BRD8011/D.

NUP5150MU

ELECTRICAL CHARACTERISTICS ($T_J = 25^\circ\text{C}$, unless otherwise specified)

Parameter	Conditions	Symbol	Min	Typ	Max	Unit
Reverse Working Voltage	(Note 1)	V_{RWM}		-	5.0	V
Breakdown Voltage	$I_T = 1 \text{ mA}$, (Note 2)	V_{BR}	6.2	6.8	7.2	V
Reverse Leakage Current	$V_{RWM} = 3 \text{ V}$	I_R	-		0.1	μA
Capacitance	$V_R = 0 \text{ V}$, $f = 1 \text{ MHz}$ (Line to GND)	C_J	-	12	15	pF

1. TVS devices are normally selected according to the working peak reverse voltage (V_{RWM}), which should be equal or greater than the DC or continuous peak operating voltage level.
2. V_{BR} is measured at pulse test current I_T .

NUP5150MU

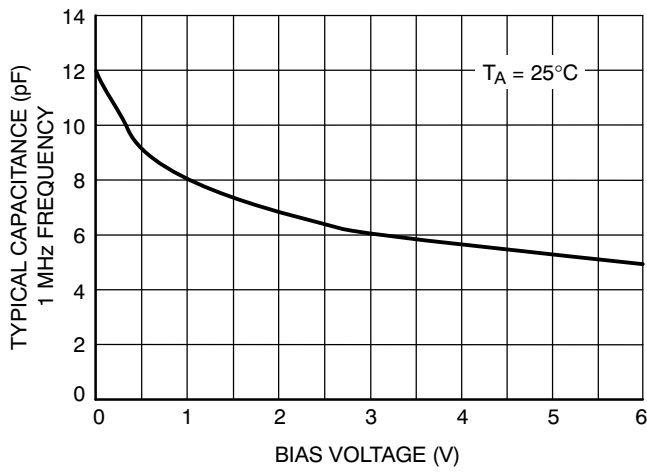

Figure 1. Capacitance

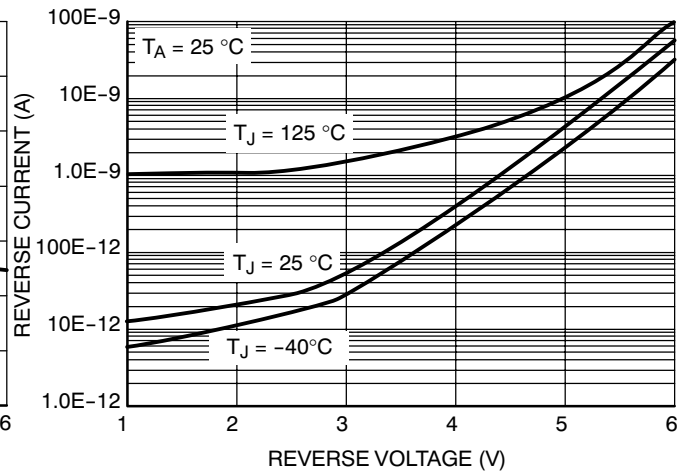

Figure 2. Typical Reverse Current vs. Reverse Voltage

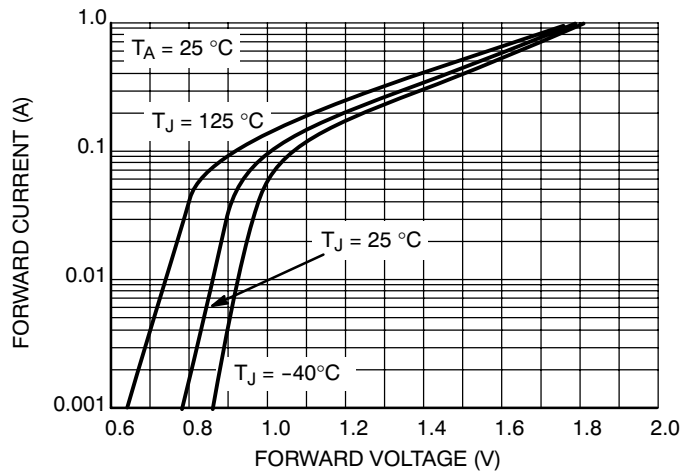
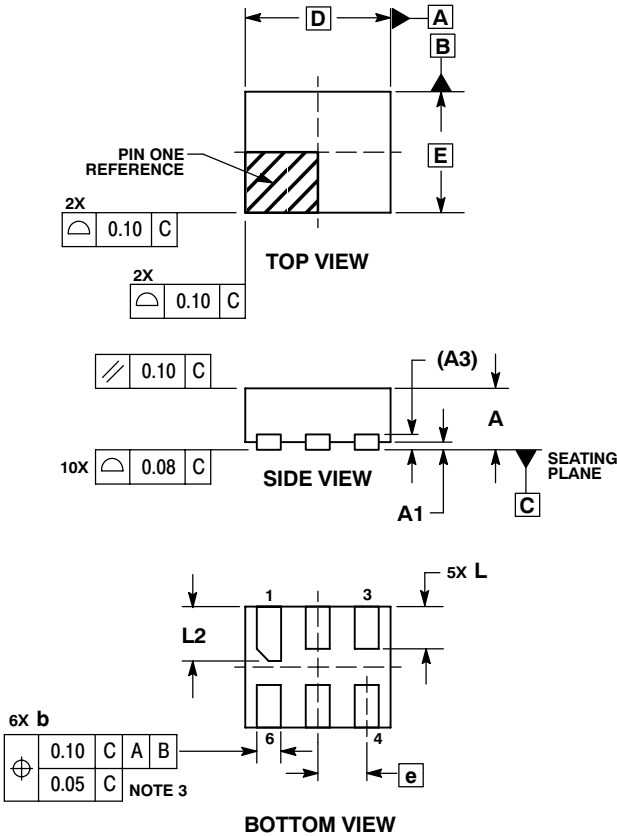

Figure 3. Typical Forward Current vs. Forward Voltage

NUP5150MU

PACKAGE DIMENSIONS

UDFN6, 1.2x1.0, 0.4P
CASE 517AA-01
ISSUE B



NOTES:

1. DIMENSIONING AND TOLERANCING PER ASME Y14.5M, 1994.
2. CONTROLLING DIMENSION: MILLIMETERS.
3. DIMENSION b APPLIES TO PLATED TERMINAL AND IS MEASURED BETWEEN 0.25 AND 0.30 mm FROM TERMINAL.
4. COPLANARITY APPLIES TO THE EXPOSED PAD AS WELL AS THE TERMINALS.

MILLIMETERS		
DIM	MIN	MAX
A	0.45	0.55
A1	0.00	0.05
A3	0.127	REF
b	0.15	0.25
D	1.20	BSC
E	1.00	BSC
e	0.40	BSC
L	0.30	0.40
L2	0.40	0.50

MOUNTING FOOTPRINT*

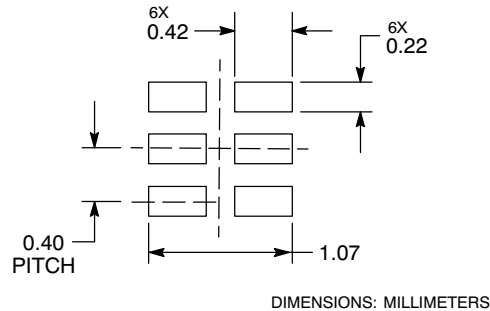

*For additional information on our Pb-Free strategy and soldering details, please download the ON Semiconductor Soldering and Mounting Techniques Reference Manual, SOLDERRM/D.

ON Semiconductor and are registered trademarks of Semiconductor Components Industries, LLC (SCILLC). SCILLC reserves the right to make changes without further notice to any products herein. SCILLC makes no warranty, representation or guarantee regarding the suitability of its products for any particular purpose, nor does SCILLC assume any liability arising out of the application or use of any product or circuit, and specifically disclaims any and all liability, including without limitation special, consequential or incidental damages. "Typical" parameters which may be provided in SCILLC data sheets and/or specifications can and do vary in different applications and actual performance may vary over time. All operating parameters, including "Typicals" must be validated for each customer application by customer's technical experts. SCILLC does not convey any license under its patent rights nor the rights of others. SCILLC products are not designed, intended, or authorized for use as components in systems intended for surgical implant into the body, or other applications intended to support or sustain life, or for any other application in which the failure of the SCILLC product could create a situation where personal injury or death may occur. Should Buyer purchase or use SCILLC products for any such unintended or unauthorized application, Buyer shall indemnify and hold SCILLC and its officers, employees, subsidiaries, affiliates, and distributors harmless against all claims, costs, damages, and expenses, and reasonable attorney fees arising out of, directly or indirectly, any claim of personal injury or death associated with such unintended or unauthorized use, even if such claim alleges that SCILLC was negligent regarding the design or manufacture of the part. SCILLC is an Equal Opportunity/Affirmative Action Employer. This literature is subject to all applicable copyright laws and is not for resale in any manner.

PUBLICATION ORDERING INFORMATION

LITERATURE FULFILLMENT:
Literature Distribution Center for ON Semiconductor
P.O. Box 5163, Denver, Colorado 80217 USA
Phone: 303-675-2175 or 800-344-3860 Toll Free USA/Canada
Fax: 303-675-2176 or 800-344-3867 Toll Free USA/Canada
Email: orderlit@onsemi.com

N. American Technical Support: 800-282-9855 Toll Free USA/Canada
Europe, Middle East and Africa Technical Support:
Phone: 421 33 790 2910
Japan Customer Focus Center
Phone: 81-3-5773-3850

ON Semiconductor Website: www.onsemi.com
Order Literature: <http://www.onsemi.com/orderlit>

For additional information, please contact your local Sales Representative

www.s-manuals.com