



P6SMB SERIES

Surface Mount Transient Voltage Suppressor



Voltage Range
6.8 to 200 Volts
600 Watts Peak Power

Features

- ✧ For surface mounted application in order to optimize board space
- ✧ Low profile package
- ✧ Built-in strain relief
- ✧ Glass passivated junction
- ✧ Excellent clamping capability
- ✧ Fast response time: Typically less than 1.0ps from 0 volt to BV min.
- ✧ Typical I_R less than 1 μ A above 10V
- ✧ High temperature soldering guaranteed:
250°C / 10 seconds at terminals
- ✧ Plastic material used carries Underwriters Laboratory
Flammability Classification 94V-0
- ✧ 600 watts peak pulse power capability with a 10 x 1000 us
waveform by 0.01% duty cycle

Mechanical Data

- ✧ Case: Molded plastic
- ✧ Terminals: Solder plated
- ✧ Polarity: Indicated by cathode band
- ✧ Standard packaging: 12mm tape (EIA STD RS-481)
- ✧ Weight: 0.093gram

SMB/DO-214AA

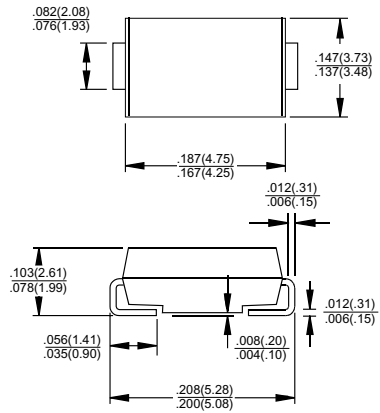

Dimensions in inches and (millimeters)

Maximum Ratings and Electrical Characteristics

Rating at 25°C ambient temperature unless otherwise specified.

Type Number	Symbol	Value	Units
Peak Power Dissipation at $T_A=25^\circ\text{C}$, $T_p=1\text{ms}$ (Note 1)	P_{PK}	Minimum 600	Watts
Peak Forward Surge Current, 8.3 ms Single Half Sine-wave Superimposed on Rated Load (JEDEC method) (Note 2, 3) - Unidirectional Only	I_{FSM}	100	Amps
Maximum Instantaneous Forward Voltage at 50.0A for Unidirectional Only (Note 4)	V_F	3.5	Volts
Operating and Storage Temperature Range	T_J, T_{STG}	-65 to + 150	$^\circ\text{C}$

Notes: 1. Non-repetitive Current Pulse Per Fig. 3 and Derated above $T_A=25^\circ\text{C}$ Per Fig. 2.

2. Mounted on 5.0mm² (.013 mm Thick) Copper Pads to Each Terminal.

3. 8.3ms Single Half Sine-wave or Equivalent Square Wave, Duty Cycle=4 pulses Per Minute Maximum.

Devices for Bipolar Applications

1. For Bidirectional Use C or CA Suffix for Types P6SMB6.8 through Types P6SMB200A.
2. Electrical Characteristics Apply in Both Directions.

ELECTRICAL CHARACTERISTICS (TA=25°C unless otherwise noted)

Device	Device Marking Code	Breakdown Voltage		Test Current @I _T (mA)	Stand-Off Voltage V _{WM} (Volts)	Maximum Reverse Leakage at V _{WM} I _D (uA)	Maximum Peak Pulse Current I _{RSM} (Note 2)(Amps)	Maximum Clamping Voltage at I _{PPM} V _C (Volts)	Maximum Temperature Coefficient of V _{BR} (%/°C)
		V _{BR} (Volts) (Note 1)							
		Min	Max						
P6SMB6.8	KDJ	6.12	7.48	10	5.50	1000	58	10.8	0.057
P6SMB6.8A	KEJ	6.45	7.14	10	5.80	1000	60	10.5	0.057
P6SMB7.5	KFJ	6.75	8.25	10	6.05	500	53	11.7	0.061
P6SMB7.5A	KGJ	7.13	7.88	10	6.40	500	55	11.3	0.061
P6SMB8.2	KHJ	7.38	9.02	1.0	6.63	200	50	12.5	0.065
P6SMB8.2A	KKJ	7.79	8.61	1.0	7.02	200	52	12.1	0.065
P6SMB9.1	KLJ	8.19	10.0	1.0	7.37	50	45	13.8	0.068
P6SMB9.1A	KMJ	8.65	9.55	1.0	7.78	50	47	13.4	0.068
P6SMB10	KNJ	9.00	11.0	1.0	8.10	10	42	15.0	0.073
P6SMB10A	KPJ	9.50	10.5	1.0	8.55	10	43	14.5	0.073
P6SMB11	KQJ	9.90	12.1	1.0	8.92	5.0	38	16.2	0.075
P6SMB11A	KRJ	10.5	11.6	1.0	9.40	5.0	40	15.6	0.075
P6SMB12	KSJ	10.8	13.2	1.0	9.72	5.0	36	17.3	0.078
P6SMB12A	KTJ	11.4	12.6	1.0	10.2	5.0	37	16.7	0.078
P6SMB13	KUJ	11.7	14.3	1.0	10.5	5.0	33	19.0	0.081
P6SMB13A	KVJ	12.4	13.7	1.0	11.1	5.0	34	18.2	0.081
P6SMB15	KWJ	13.5	16.5	1.0	12.1	5.0	28	22.0	0.084
P6SMB15A	KXJ	14.3	15.8	1.0	12.8	5.0	29	21.2	0.084
P6SMB16	KYJ	14.4	17.6	1.0	12.9	5.0	26	23.5	0.086
P6SMB16A	KZJ	15.2	16.8	1.0	13.6	5.0	28	22.5	0.086
P6SMB18	LDJ	16.2	19.8	1.0	14.5	5.0	23	26.5	0.088
P6SMB18A	LEJ	17.1	18.9	1.0	15.3	5.0	25	25.2	0.088
P6SMB20	LFJ	18.0	22.0	1.0	16.2	5.0	21	29.1	0.090
P6SMB20A	LGJ	19.0	21.0	1.0	17.1	5.0	22	27.7	0.090
P6SMB22	LHJ	19.8	24.2	1.0	17.8	5.0	19	31.9	0.092
P6SMB22A	LKJ	20.9	23.1	1.0	18.8	5.0	20	30.6	0.092
P6SMB24	LLJ	21.6	26.4	1.0	19.4	5.0	18	34.7	0.094
P6SMB24A	LMJ	22.8	25.2	1.0	20.5	5.0	19	33.2	0.094
P6SMB27	LNJ	24.3	29.7	1.0	21.8	5.0	16	39.1	0.096
P6SMB27A	LPJ	25.7	28.4	1.0	23.1	5.0	16.8	37.5	0.096
P6SMB30	LQJ	27.0	33.0	1.0	24.3	5.0	14	43.5	0.097
P6SMB30A	LRJ	28.5	31.5	1.0	25.6	5.0	15	41.4	0.097
P6SMB33	LSJ	29.7	36.3	1.0	26.8	5.0	13.0	47.7	0.098
P6SMB33A	LTJ	31.4	34.7	1.0	28.2	5.0	13.8	45.7	0.098
P6SMB36	LUJ	32.4	39.6	1.0	29.1	5.0	12	52.0	0.099
P6SMB36A	LVJ	34.2	37.8	1.0	30.8	5.0	12.6	49.9	0.099
P6SMB39	LWJ	35.1	42.9	1.0	31.6	5.0	11.1	56.4	0.100
P6SMB39A	LXJ	37.1	41.0	1.0	33.3	5.0	11.6	53.9	0.100
P6SMB43	LYJ	38.7	47.3	1.0	34.8	5.0	10.0	61.9	0.101
P6SMB43A	LZJ	40.9	45.2	1.0	36.8	5.0	10.6	59.3	0.101
P6SMB47	MDJ	42.3	51.7	1.0	38.1	5.0	9.2	67.8	0.101
P6SMB47A	MEJ	44.7	49.4	1.0	40.2	5.0	9.7	64.8	0.101
P6SMB51	MFJ	45.9	56.1	1.0	41.3	5.0	8.5	73.5	0.102
P6SMB51A	MGJ	48.5	53.6	1.0	43.6	5.0	8.9	70.1	0.102
P6SMB56	MHJ	50.4	61.6	1.0	45.4	5.0	7.8	80.5	0.103
P6SMB56A	MKJ	53.2	58.8	1.0	47.8	5.0	8.1	77.0	0.103
P6SMB62	MLJ	55.8	68.2	1.0	50.2	5.0	7.0	89.0	0.104
P6SMB62A	MMJ	58.9	65.1	1.0	53.0	5.0	7.4	85.0	0.104
P6SMB68	MNJ	61.2	74.8	1.0	55.1	5.0	6.4	98.0	0.104
P6SMB68A	MPJ	64.6	71.4	1.0	58.1	5.0	6.8	92.0	0.104
P6SMB75	MQJ	67.5	82.5	1.0	60.7	5.0	5.8	108.0	0.105
P6SMB75A	MRJ	71.3	78.8	1.0	64.1	5.0	6.1	103.0	0.105
P6SMB82	MSJ	73.8	90.2	1.0	66.4	5.0	5.3	118.0	0.105
P6SMB82A	MTJ	77.9	86.1	1.0	70.1	5.0	5.5	113.0	0.105

ELECTRICAL CHARACTERISTICS (TA=25°C unless otherwise noted)

Device	Device Marking Code	Breakdown Voltage		Test Current @I _T (mA)	Stand-Off Voltage V _{WM} (Volts)	Maximum Reverse Leakage at V _{WM} I _D (uA)	Maximum Peak Pulse Current I _{RSM} (Note 2)(Amps)	Maximum Clamping Voltage at I _{PPM} V _C (Volts)	Maximum Temperature Coefficient of V _{BR} (% / °C)
		V _{BR} (Volts) (Note 1)							
		Min	Max						
P6SMB91	MUJ	81.9	100.0	1.0	73.7	5.0	4.8	131.0	0.106
P6SMB91A	MVJ	86.5	95.5	1.0	77.8	5.0	5.0	125.0	0.106
P6SMB100	MWJ	90.0	110.0	1.0	81.0	5.0	4.3	144.0	0.106
P6SMB100A	MXJ	95.0	105.0	1.0	85.5	5.0	4.5	137.0	0.106
P6SMB110	MYJ	99.0	121.0	1.0	89.2	5.0	3.9	158.0	0.107
P6SMB110A	MZJ	105.0	116.0	1.0	94.0	5.0	4.1	152.0	0.107
P6SMB120	NDJ	108.0	132.0	1.0	97.2	5.0	3.6	173.0	0.107
P6SMB120A	NEJ	114.0	126.0	1.0	102.0	5.0	3.8	165.0	0.107
P6SMB130	NFJ	117.0	143.0	1.0	105.0	5.0	3.3	187.0	0.107
P6SMB130A	NGJ	124.0	137.0	1.0	111.0	5.0	3.5	179.0	0.107
P6SMB150	NHJ	135.0	165.0	1.0	121.0	5.0	2.9	215.0	0.108
P6SMB150A	NKJ	143.0	158.0	1.0	128.0	5.0	3.0	207.0	0.108
P6SMB160	NLJ	144.0	176.0	1.0	130.0	5.0	2.7	230.0	0.108
P6SMB160A	NMJ	152.0	168.0	1.0	136.0	5.0	2.8	219.0	0.108
P6SMB170	NNJ	153.0	187.0	1.0	138.0	5.0	2.5	244.0	0.108
P6SMB170A	NPJ	162.0	179.0	1.0	145.0	5.0	2.6	234.0	0.108
P6SMB180	NQJ	162.0	198.0	1.0	146.0	5.0	2.4	258.0	0.108
P6SMB180A	NRJ	171.0	189.0	1.0	154.0	5.0	2.5	246.0	0.108
P6SMB200	NSJ	180.0	220.0	1.0	162.0	5.0	2.1	287.0	0.108
P6SMB200A	NTJ	190.0	210.0	1.0	171.0	5.0	2.2	274.0	0.108

Notes:

1. V_{BR} measured after I_T applied for 300us, I_T=square wave pulse or equivalent.
2. Surge current waveform per Figure 3 and derate per Figure 2.
3. For bipolar types having V_{WM} of 10 volts and under, the I_D limit is doubled.
4. For bidirectional use C or Ca suffix for types P6SMB6.8 through P6SMB200A.
5. All terms and symbols are consistent with ANSI/IEEE C62.35.

RATINGS AND CHARACTERISTIC CURVES (P6SMB SERIES)

FIG.1- PEAK PULSE POWER RATING CURVE

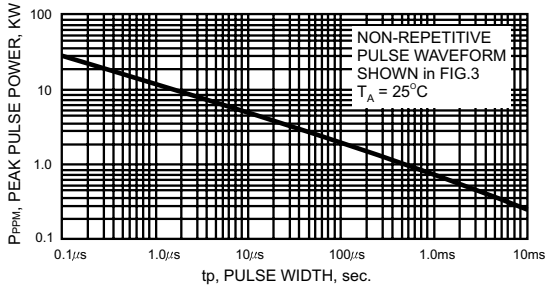

FIG.2- PULSE DERATING CURVE

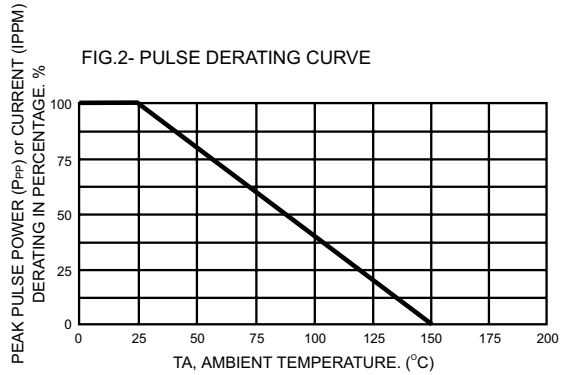

FIG.3- PULSE WAVEFORM

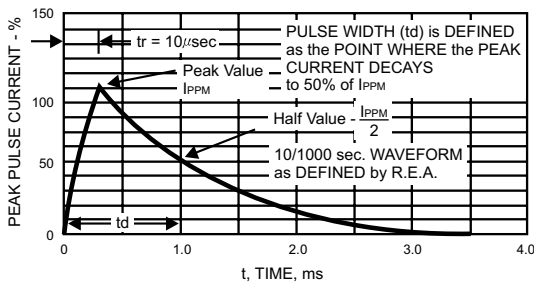

FIG.4- MAXIMUM NON-REPETITIVE FORWARD SURGE CURRENT UNIDIRECTIONAL ONLY

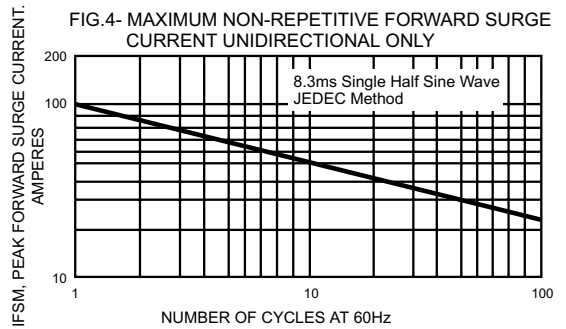

FIG.5- TYPICAL REVERSE LEAKAGE CHARACTERISTICS

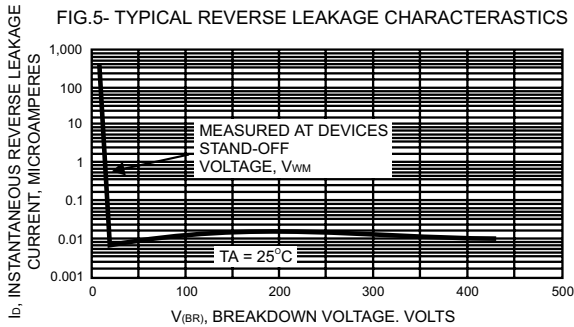
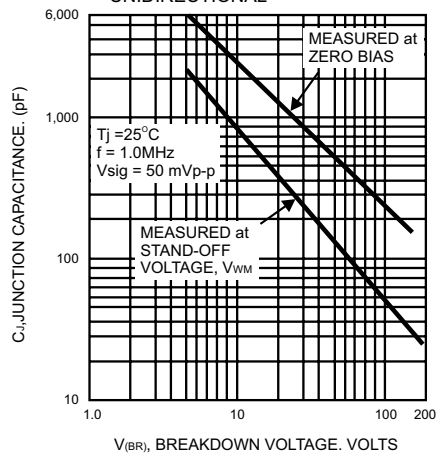

FIG.6- TYPICAL JUNCTION CAPACITANCE UNIDIRECTIONAL



www.s-manuals.com