

# 500mA Peak, Thermal Folded Back CMOS LDO Regulator

## General Description

The RT9016 is designed for portable RF and wireless applications with demanding performance and space requirements. The RT9016 performance is optimized for battery-powered systems to deliver ultra low noise and low quiescent current. A noise bypass pin is available for further reduction of output noise. Regulator ground current increases only slightly in dropout, further prolonging the battery life. The RT9016 also works with low-ESR ceramic capacitors, reducing the amount of board space necessary for power applications, critical in hand-held wireless devices. The RT9016 consumes less than 0.01μA in shutdown mode and has fast turn-on time less than 50μs. RT9016 is short circuit thermal folded back protected. RT9016 lowers its OTP trip point from 165°C to 110°C when output short circuit occurs ( $V_{OUT} < 0.4V$ ) providing maximum safety to end users. The other features include ultra low dropout voltage, high output accuracy, current limiting protection, and high ripple rejection ratio. Available in the SOT-23-5 and WDFN-6L 2x2 packages.

## Ordering Information

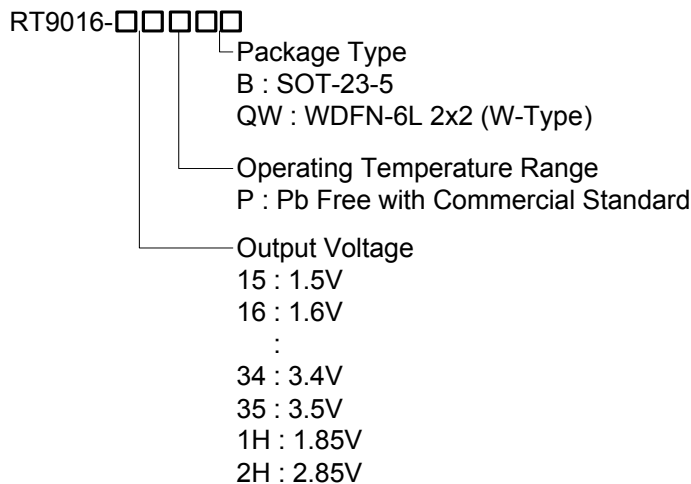

Note :

RichTek Pb-free products are :

- ▶RoHS compliant and compatible with the current requirements of IPC/JEDEC J-STD-020.
- ▶Suitable for use in SnPb or Pb-free soldering processes.
- ▶100% matte tin (Sn) plating.

## Features

- Short Circuit Thermal Folded Back Protection
- Ultra-Low-Noise for RF Application
- Ultra-Fast Response in Line/Load Transient
- Quick Start-Up (Typically 50μs)
- 0.01μA Standby Current When Shutdown
- Low Dropout : 380mV @ 500mA
- Wide Operating Voltage Ranges : 2.5V to 5.5V
- TTL-Logic-Controlled Shutdown Input
- Low Temperature Coefficient
- Current Limiting Protection
- Thermal Shutdown Protection
- Only 1μF Output Capacitor Required for Stability
- High Power Supply Rejection Ratio
- Custom Voltage Available
- RoHS Compliant and 100% Lead (Pb)-Free

## Applications

- CDMA/GSM Cellular Handsets
- Battery-Powered Equipment
- Laptop, Palmtops, Notebook Computers
- Hand-Held Instruments
- PCMCIA Cards
- Portable Information Appliances

## Marking Information

For marking information, contact our sales representative directly or through a RichTek distributor located in your area, otherwise visit our website for detail.

## Pin Configurations

(TOP VIEW)

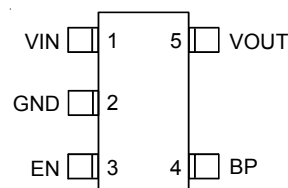

SOT-23-5

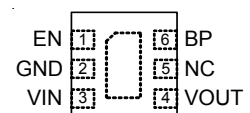

WDFN-6L 2x2

### Typical Application Circuit

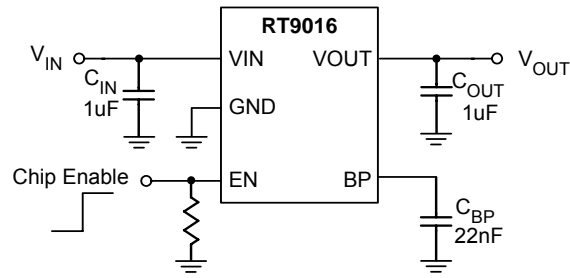

### Functional Pin Description

Pin Name	Pin Function
VIN	Input Voltage.
GND	Ground.
EN	Chip Enable (Active High). Note that this pin is high impedance. There should be a pull low 100kΩ resistor connected to GND when the control signal is floating.
BP	Reference Noise Bypass.
VOUT	Output Voltage.

### Function Block Diagram

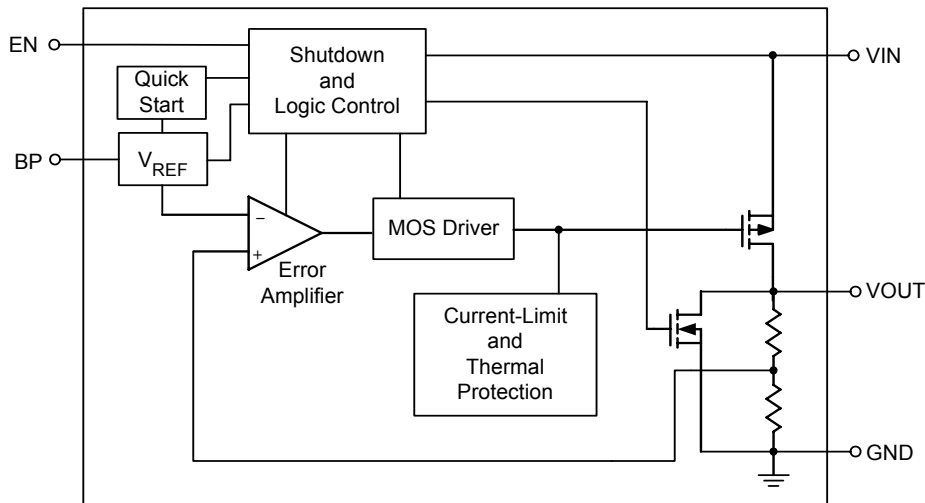

**Absolute Maximum Ratings** (Note 1)

- Supply Input Voltage ----- 6V
- Power Dissipation,  $P_D$  @  $T_A = 25^\circ\text{C}$ 
  - SOT-23-5 ----- 400mW
  - WDFN-6L 2x2 ----- 606mW
- Package Thermal Resistance (Note 4)
  - SOT-23-5,  $\theta_{JA}$  ----- 250°C/W
  - WDFN-6L 2x2,  $\theta_{JA}$  ----- 165°C/W
- Lead Temperature (Soldering, 10 sec.) ----- 260°C
- Junction Temperature ----- 150°C
- Storage Temperature Range ----- -65°C to 150°C
- ESD Susceptibility (Note 2)
  - HBM (Human Body Mode) ----- 2kV
  - MM (Machine Mode) ----- 200V

**Recommended Operating Conditions** (Note 3)

- Supply Input Voltage ----- 2.5V to 5.5V
- Junction Temperature Range ----- -40°C to 125°C
- Ambient Temperature Range ----- -40°C to 85°C

**Electrical Characteristics**

( $V_{IN} = V_{OUT} + 1V$ ,  $C_{IN} = C_{OUT} = 1\mu\text{F}$ ,  $C_{BP} = 22\text{nF}$ ,  $T_A = 25^\circ\text{C}$ , unless otherwise specified)

Parameter		Symbol	Test Conditions	Min	Typ	Max	Units
Output Voltage Accuracy		$\Delta V_{OUT}$	$I_{OUT} = 1\text{mA}$	-2	--	+2	%
Current Limit		$I_{LIM}$	$R_{LOAD} = 1\Omega$	530	--	--	mA
Quiescent Current		$I_Q$	$V_{EN} \geq 1.2V$ , $I_{OUT} = 0\text{mA}$	--	90	130	$\mu\text{A}$
Dropout Voltage (Note 5)		$V_{DROP}$	$I_{OUT} = 300\text{mA}$ , $V_{OUT} > 2.8V$	--	220	--	mV
			$I_{OUT} = 500\text{mA}$ , $V_{OUT} > 2.8V$	--	380	--	
Line Regulation		$\Delta V_{LINE}$	$V_{IN} = (V_{OUT} + 0.3V)$ to 5.5V, $I_{OUT} = 1\text{mA}$	--	--	0.3	%
Load Regulation		$\Delta V_{LOAD}$	$1\text{mA} < I_{OUT} < 500\text{mA}$	--	--	0.6	%
Standby Current		$I_{STBY}$	$V_{EN} = \text{GND}$ , Shutdown	--	0.01	1	$\mu\text{A}$
EN Input Bias Current		$I_{IBSD}$	$V_{EN} = \text{GND}$ or $V_{IN}$	--	0	100	nA
EN Threshold	Logic-Low Voltage	$V_{IL}$	$V_{IN} = 3V$ to 5.5V, Shutdown	--	--	0.4	V
	Logic-High Voltage	$V_{IH}$	$V_{IN} = 3V$ to 5.5V, Start-Up	1.2	--	--	
Output Noise Voltage		$e_{NO}$	10Hz to 100kHz, $I_{OUT} = 200\text{mA}$ $C_{OUT} = 1\mu\text{F}$	--	100	--	$\mu\text{V}_{RMS}$
Power Supply Rejection Rate	f = 100Hz	PSRR	$C_{OUT} = 1\mu\text{F}$ , $I_{OUT} = 10\text{mA}$	--	-70	--	dB
	f = 10kHz			--	-50	--	

To be continued

Parameter	Symbol	Test Conditions	Min	Typ	Max	Units
Thermal Shutdown Temperature	$T_{SD}$		--	165	--	°C
Thermal Shutdown Temperature Hysteresis	$\Delta T_{SD}$		--	30	--	°C
Thermal Folded Back			--	110	--	°C

**Note 1.** Stresses listed as the above "Absolute Maximum Ratings" may cause permanent damage to the device. These are for stress ratings. Functional operation of the device at these or any other conditions beyond those indicated in the operational sections of the specifications is not implied. Exposure to absolute maximum rating conditions for extended periods may remain possibility to affect device reliability.

**Note 2.** Devices are ESD sensitive. Handling precaution recommended.

**Note 3.** The device is not guaranteed to function outside its operating conditions.

**Note 4.**  $\theta_{JA}$  is measured in the natural convection at  $T_A = 25^\circ\text{C}$  on a low effective thermal conductivity test board (Single Layer, 1S) of JEDEC 51-3 thermal measurement standard.

**Note 5.** The dropout voltage is defined as  $V_{IN} - V_{OUT}$ , which is measured when  $V_{OUT}$  is  $V_{OUT(NORMAL)} - 100\text{mV}$ .

**Typical Operating Characteristics**

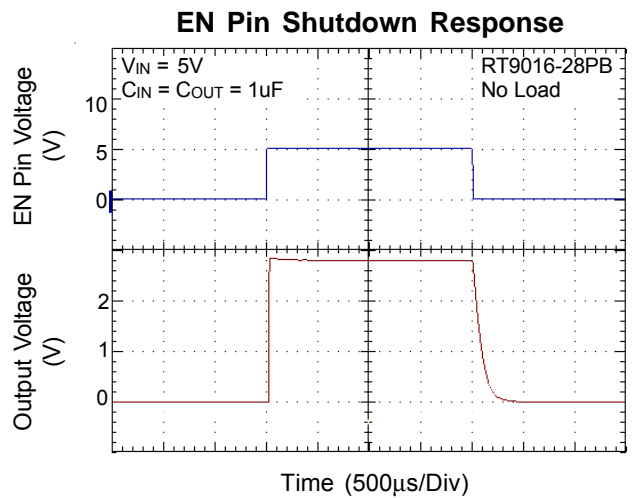
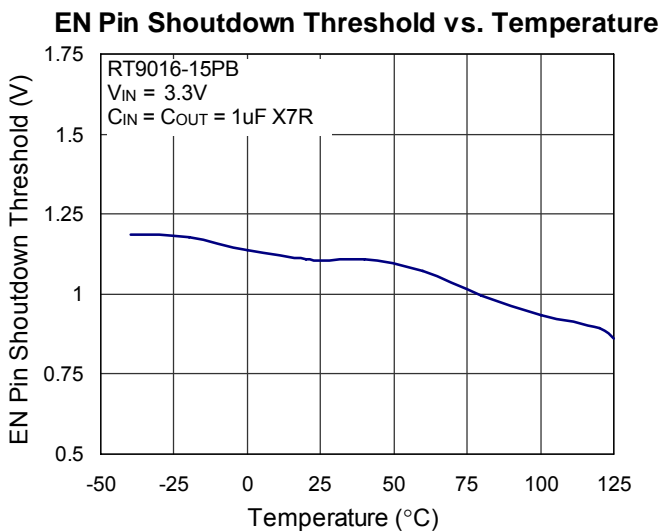
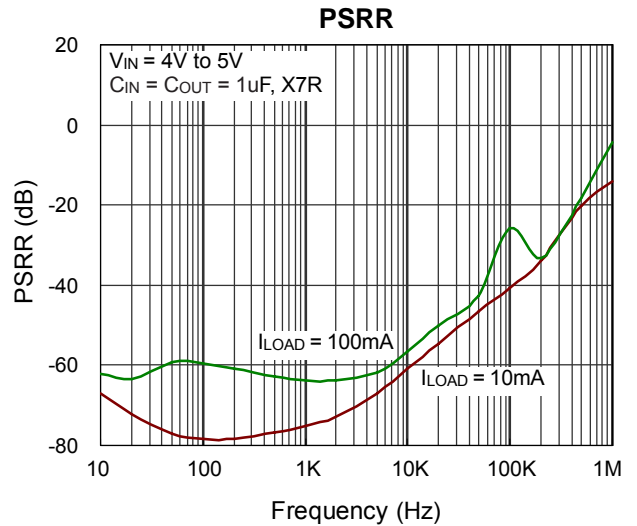
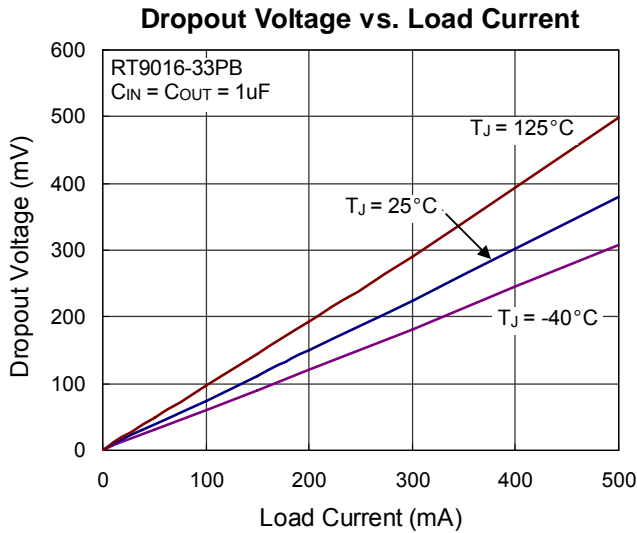
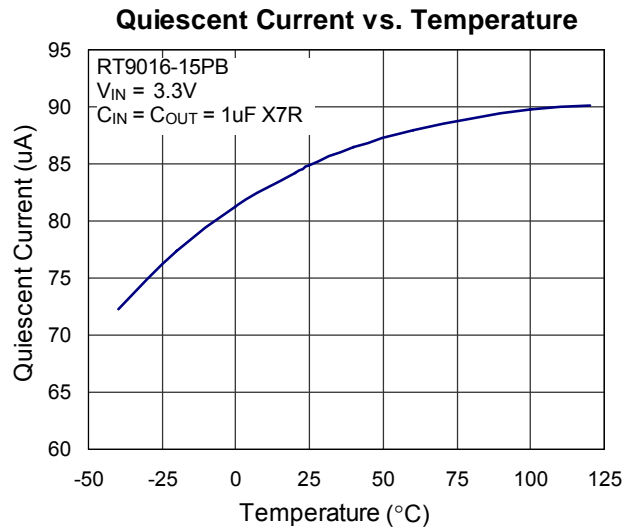
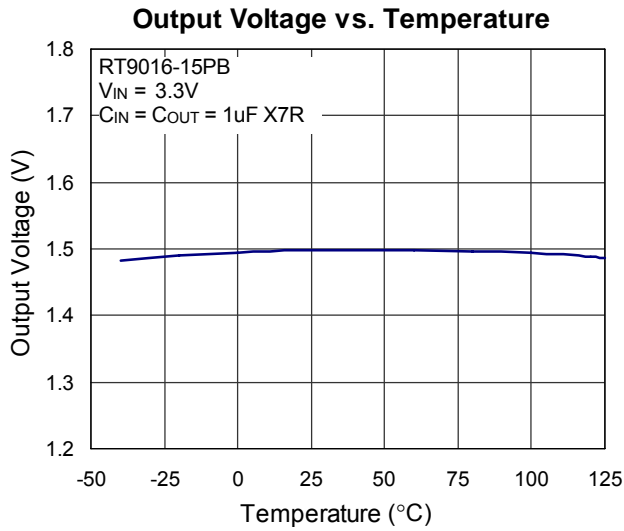

Load Transient Response

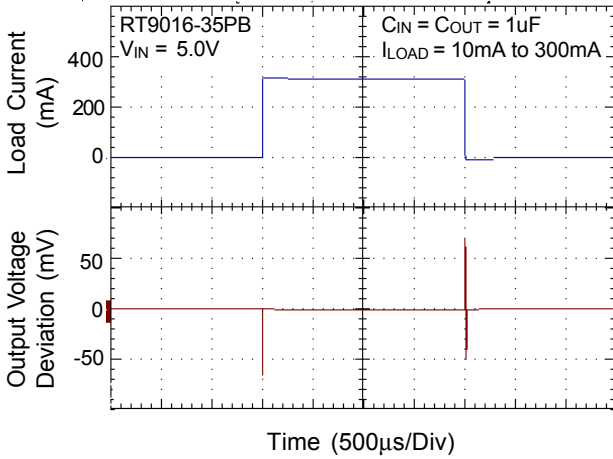

Load Transient Response

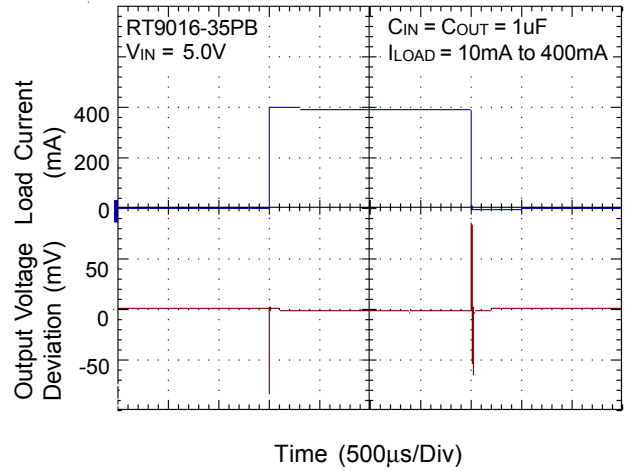

Line Transient Response

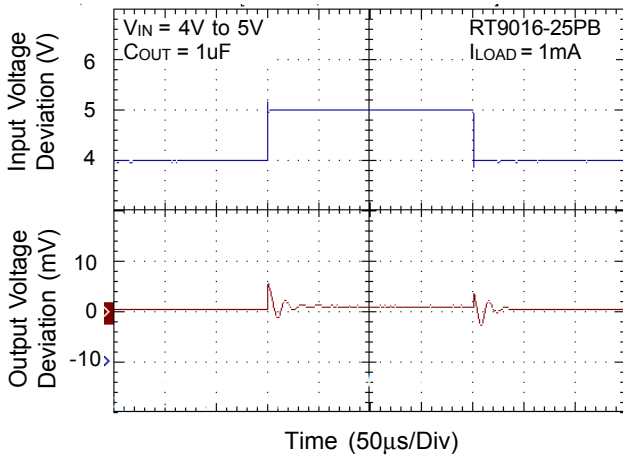

Line Transient Response

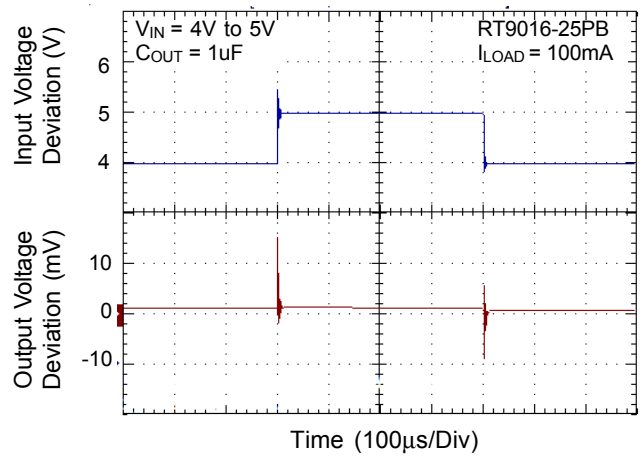

Noise

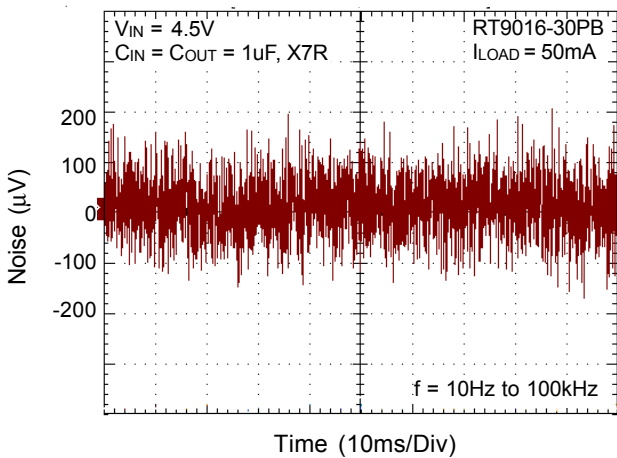

Noise

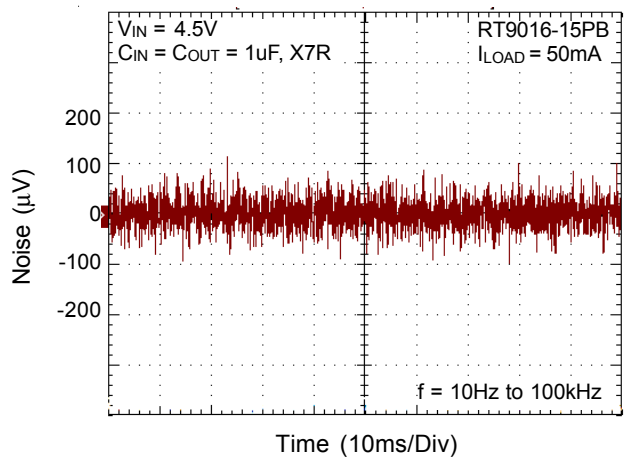

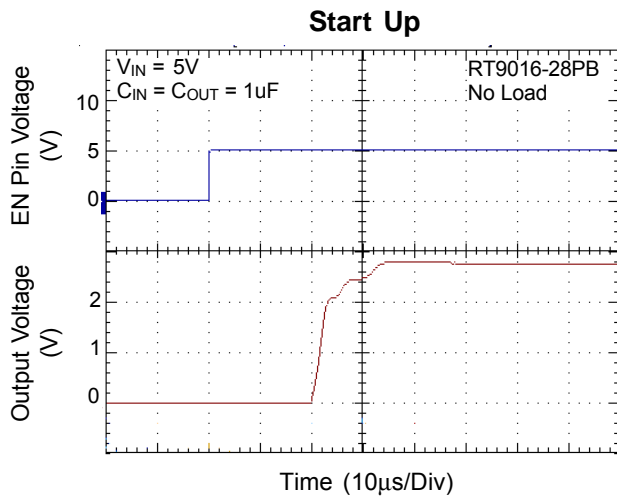

## Applications Information

Like any low-dropout regulator, the external capacitors used with the RT9016 must be carefully selected for regulator stability and performance. Using a capacitor whose value is  $> 1\mu\text{F}$  on the RT9016 input and the amount of capacitance can be increased without limit. The input capacitor must be located a distance of not more than 0.5 inch from the input pin of the IC and returned to a clean analog ground. Any good quality ceramic or tantalum can be used for this capacitor. The capacitor with larger value and lower ESR (equivalent series resistance) provides better PSRR and line-transient response. The output capacitor must meet both requirements for minimum amount of capacitance and ESR in all LDOs application. The RT9016 is designed specifically to work with low ESR ceramic output capacitor in space-saving and performance consideration. Using a ceramic capacitor whose value is at least  $1\mu\text{F}$  with ESR is  $> 25\text{m}\Omega$  on the RT9016 output ensures stability. The RT9016 still works well with output capacitor of other types due to the wide stable ESR range. Figure 1 shows the curves of allowable ESR range as a function of load current for various output capacitor values. Output capacitor of larger capacitance can reduce noise and improve load transient response, stability, and PSRR. The output capacitor should be located not more than 0.5 inch from the  $V_{\text{OUT}}$  pin of the RT9016 and returned to a clean analog ground.

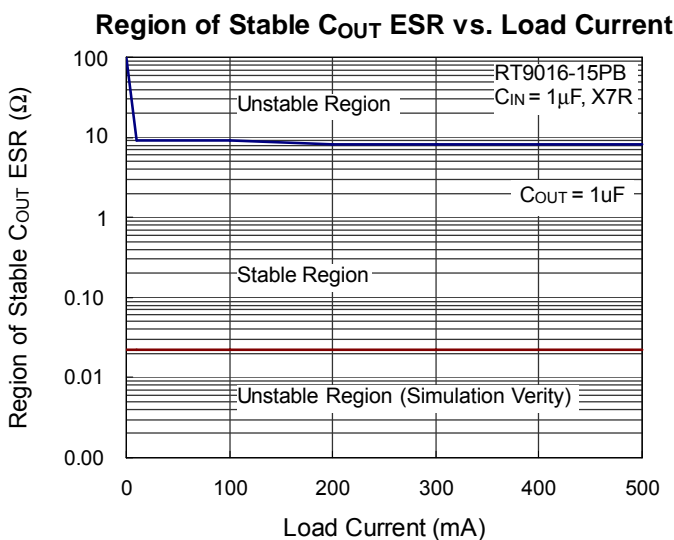

Figure 1

### Bypass Capacitor and Low Noise

Connecting a 22nF between the BP pin and GND pin significantly reduces noise on the regulator output, it is critical that the capacitor connection between the BP pin and GND pin be direct and PCB traces should be as short as possible. There is a relationship between the bypass capacitor value and the LDO regulator turn on time. DC leakage on this pin can affect the LDO regulator output noise and voltage regulation performance.

### Enable Function

The RT9016 features an LDO regulator enable/disable function. To assure the LDO regulator will switch on, the EN turn on control level must be greater than 1.2 volts. The LDO regulator will go into the shutdown mode when the voltage on the EN pin falls below 0.4 volts. For protecting the system, the RT9016 have a quick-discharge function. If the enable function is not needed in a specific application, it may be tied to  $V_{\text{IN}}$  to keep the LDO regulator in a continuously on state.

### Thermal Considerations

Thermal protection limits power dissipation in RT9016. When the operation junction temperature exceeds  $165^{\circ}\text{C}$ , the OTP circuit starts the thermal shutdown function turn the pass element off. The pass element turn on again after the junction temperature cools by  $30^{\circ}\text{C}$ .

RT9016 lowers its OTP trip level from  $165^{\circ}\text{C}$  to  $110^{\circ}\text{C}$  when output short circuit occurs ( $V_{\text{OUT}} < 0.4\text{V}$ ) as shown in Figure 2. This limits IC case temperature under  $100^{\circ}\text{C}$  and provides maximum safety to end users when output short circuit occurs.

For continue operation, do not exceed absolute maximum operation junction temperature  $125^{\circ}\text{C}$ . The power dissipation definition in device is :

$$P_D = (V_{\text{IN}} - V_{\text{OUT}}) \times I_{\text{OUT}} + V_{\text{IN}} \times I_Q$$

The maximum power dissipation depends on the thermal resistance of IC package, PCB layout, the rate of surroundings airflow and temperature difference between junction to ambient. The maximum power dissipation can be calculated by following formula :



$$P_{D(MAX)} = (T_{J(MAX)} - T_A) / \theta_{JA}$$

Where  $T_{J(MAX)}$  is the maximum operation junction temperature 125°C,  $T_A$  is the ambient temperature and the  $\theta_{JA}$  is the junction to ambient thermal resistance.

For recommended operating conditions specification of RT9016, where  $T_{J(MAX)}$  is the maximum junction temperature of the die (125°C) and  $T_A$  is the maximum ambient temperature. The junction to ambient thermal resistance ( $\theta_{JA}$  is layout dependent) for SOT-23-5 package is 250°C/W and WDFN-6L 2x2 package is 165°C/W on standard JEDEC 51-3 thermal test board. The maximum power dissipation at  $T_A = 25^\circ\text{C}$  can be calculated by following formula :

$$P_{D(MAX)} = (125^\circ\text{C} - 25^\circ\text{C}) / 250 = 400\text{mW (SOT-23-5)}$$

$$P_{D(MAX)} = (125^\circ\text{C} - 25^\circ\text{C}) / 165 = 606\text{mW V(DFN-6L 2x2)}$$

The maximum power dissipation depends on operating ambient temperature for fixed  $T_{J(MAX)}$  and thermal resistance  $\theta_{JA}$ . For RT9016 packages, the Figure 3 of derating curves allows the designer to see the effect of rising ambient temperature on the maximum power allowed.

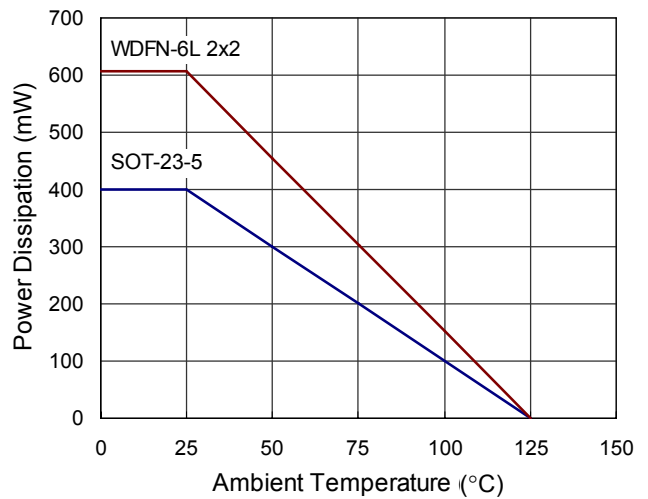

Figure 3. Derating Curve for Packages

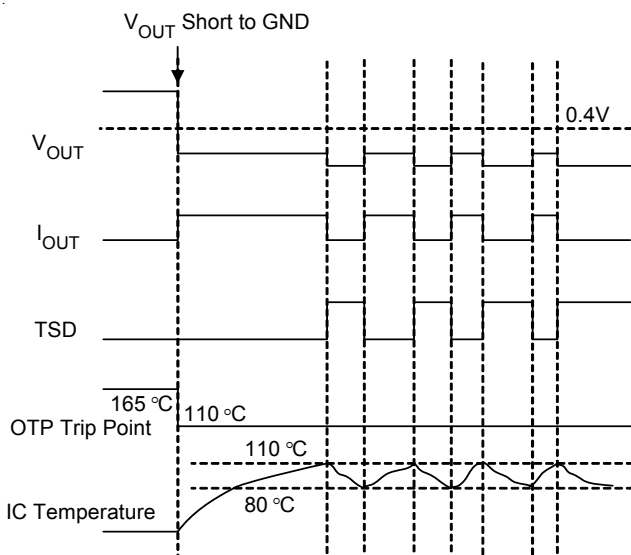
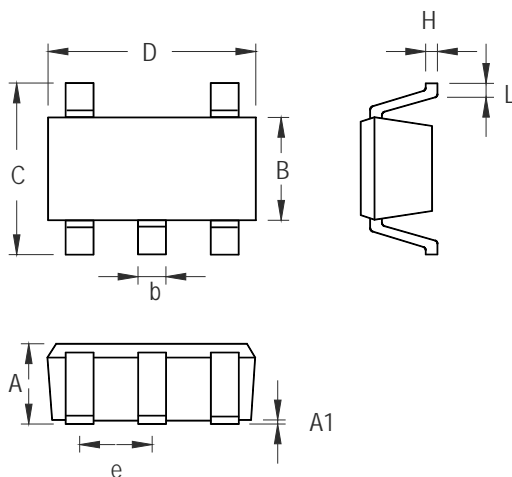

Figure 2. Short Circuit Thermal Folded Back Protection when Output Short Circuit Occurs

Outline Dimension



Symbol	Dimensions In Millimeters		Dimensions In Inches	
	Min	Max	Min	Max
A	0.889	1.295	0.035	0.051
A1	0.000	0.152	0.000	0.006
B	1.397	1.803	0.055	0.071
b	0.356	0.559	0.014	0.022
C	2.591	2.997	0.102	0.118
D	2.692	3.099	0.106	0.122
e	0.838	1.041	0.033	0.041
H	0.080	0.254	0.003	0.010
L	0.300	0.610	0.012	0.024

SOT-23-5 Surface Mount Package

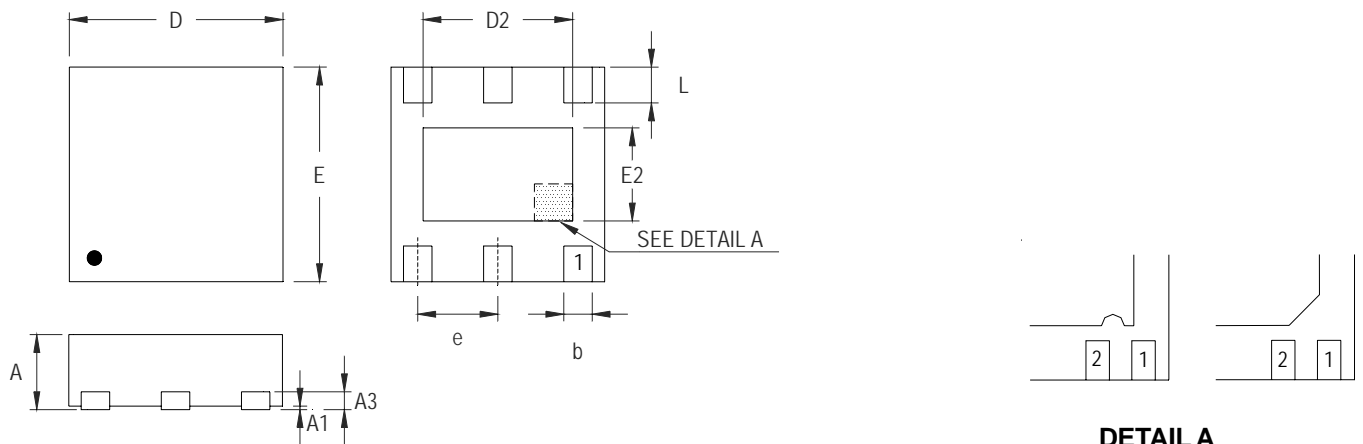

**DETAIL A**

Pin #1 ID and Tie Bar Mark Options

Note : The configuration of the Pin #1 identifier is optional, but must be located within the zone indicated.

Symbol	Dimensions In Millimeters		Dimensions In Inches	
	Min	Max	Min	Max
A	0.700	0.800	0.028	0.031
A1	0.000	0.050	0.000	0.002
A3	0.175	0.250	0.007	0.010
b	0.200	0.350	0.008	0.014
D	1.950	2.050	0.077	0.081
D2	1.000	1.450	0.039	0.057
E	1.950	2.050	0.077	0.081
E2	0.500	0.850	0.020	0.033
e	0.650		0.026	
L	0.300	0.400	0.012	0.016

**W-Type 6L DFN 2x2 Package**

**RICHTEK TECHNOLOGY CORP.**

Headquarter  
5F, No. 20, Taiyuen Street, Chupei City  
Hsinchu, Taiwan, R.O.C.  
Tel: (8863)5526789 Fax: (8863)5526611

**RICHTEK TECHNOLOGY CORP.**

Taipei Office (Marketing)  
8F-1, No. 137, Lane 235, Paochiao Road, Hsintien City  
Taipei County, Taiwan, R.O.C.  
Tel: (8862)89191466 Fax: (8862)89191465  
Email: marketing@richtek.com

[www.s-manuals.com](http://www.s-manuals.com)