

# DC-DC Converter (-20V, -2.5A)

## RTQ025P02

**●Features**

- 1) Low On-resistance.(140mΩ at 2.5V)
- 2) High Power Package.
- 3) High speed switching.
- 4) Low voltage drive.(2.5V)

**●Applications**

DC-DC converter

**●Structure**

Silicon P-channel  
MOSFET

**●Packaging specifications**

Type	Package	Taping
	Code	TR
	Basic ordering unit (pieces)	3000
RTQ025P02		○

**●External dimensions (Units : mm)**

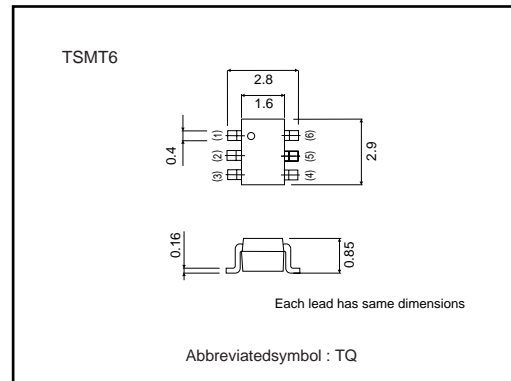

**●Equivalent circuit**

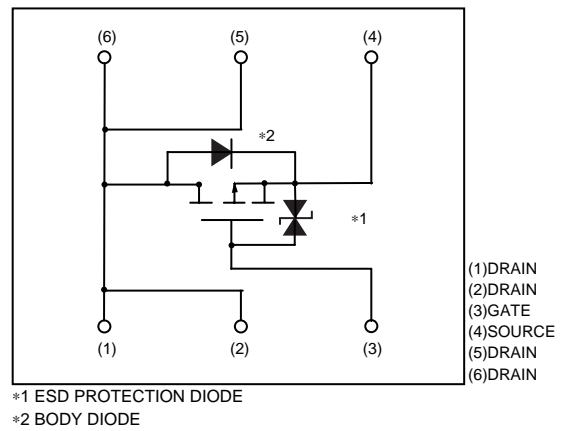

## Transistor

## ●Absolute maximum ratings (Ta=25°C)

Parameter	Symbol	Limits	Unit
Drain-source voltage	V <sub>DSS</sub>	-20	V
Gate-source voltage	V <sub>GSS</sub>	±12	V
Drain current	Continuous	I <sub>D</sub>	±2.5
	Pulsed	I <sub>DP</sub>	±10
Source current (Body diode)	Continuous	I <sub>S</sub>	-1
	Pulsed	I <sub>SP</sub>	-4
Total power dissipation	P <sub>D</sub>	1.25	W <sup>*2</sup>
Channel temperature	T <sub>ch</sub>	150	°C
Range of Storage temperature	T <sub>stg</sub>	-55~+150	°C

\*1 P<sub>w</sub>≤10μs, Duty cycle≤1%

\*2 Mounted on a ceramic board

## ●Electrical characteristics (Ta=25°C)

Parameter	Symbol	Min.	Typ.	Max.	Unit	Conditions
Gate-source leakage	I <sub>GSS</sub>	-	-	±10	μA	V <sub>GS</sub> =±12V, V <sub>DS</sub> =0V
Drain-source breakdown voltage	V <sub>(BR)DSS</sub>	-20	-	-	V	I <sub>D</sub> =-1mA, V <sub>GS</sub> =0V
Zero gate voltage drain current	I <sub>DSS</sub>	-	-	-1	μA	V <sub>DS</sub> =-20V, V <sub>GS</sub> =0V
Gate threshold voltage	V <sub>GS(th)</sub>	-0.7	-	-2.0	V	V <sub>DS</sub> =-10V, I <sub>D</sub> =-1mA
Static drain-source on-state resistance	R <sub>DS(on)</sub> <sup>*</sup>	-	72	100	mΩ	I <sub>D</sub> =-2.5A, V <sub>GS</sub> =-4.5V
		-	80	110	mΩ	I <sub>D</sub> =-2.5A, V <sub>GS</sub> =-4V
		-	140	190	mΩ	I <sub>D</sub> =-1.2A, V <sub>GS</sub> =-2.5V
Forward transfer admittance	Y <sub>fs</sub>   <sup>*</sup>	2.0	-	-	S	V <sub>DS</sub> =-10V, I <sub>D</sub> =-1.2A
Input capacitance	C <sub>iss</sub>	-	580	-	pF	V <sub>DS</sub> =-10V, V <sub>GS</sub> =0V f=1MHz
Output capacitance	C <sub>oss</sub>	-	110	-	pF	
Reverse transfer capacitance	C <sub>rss</sub>	-	80	-	pF	
Turn-on delay time	t <sub>d(on)</sub> <sup>*</sup>	-	12	-	ns	I <sub>D</sub> =-1.2A V <sub>DD</sub> =-15V V <sub>GS</sub> =-4.5V R <sub>L</sub> =12.5Ω R <sub>GS</sub> =10Ω
Rise time	t <sub>r</sub> <sup>*</sup>	-	20	-	ns	
Turn-off delay time	t <sub>d(off)</sub> <sup>*</sup>	-	40	-	ns	
Fall time	t <sub>f</sub> <sup>*</sup>	-	17	-	ns	
Total gate charge	Q <sub>g</sub>	-	6.4	-	nC	V <sub>DD</sub> =-15V V <sub>GS</sub> =-4.5V I <sub>D</sub> =-2.5A
Gate-source charge	Q <sub>gs</sub>	-	1.4	-	nC	
Gate-drain charge	Q <sub>gd</sub>	-	1.9	-	nC	
*PULSED						
Body diode characteristics (source-drain characteristics)						
Forward voltage	V <sub>SD</sub>	-	-	-1.2	V	I <sub>S</sub> =-1A, V <sub>GS</sub> =0V

Transistor

●Electrical characteristic curves

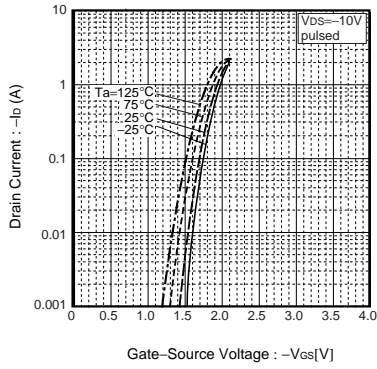

Fig.1 Typical Transfer Characteristics

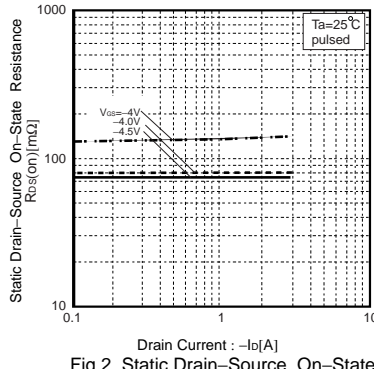

Fig.2 Static Drain-Source On-State Resistance vs. Drain Current

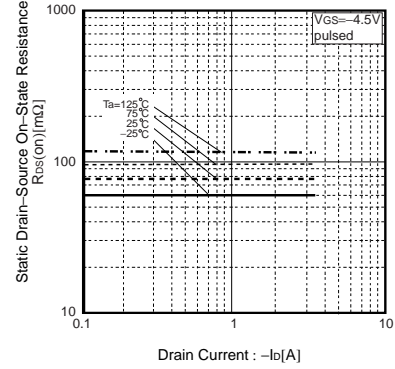

Fig.3 Static Drain-Source On-State Resistance vs. Drain Current

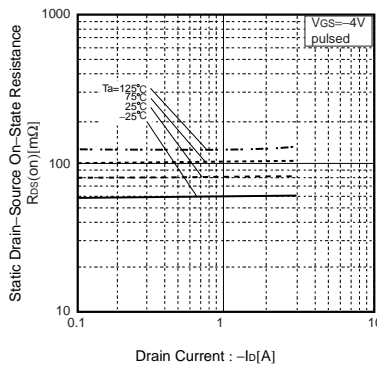

Fig.4 Static Drain-Source On-State Resistance vs. Drain Current

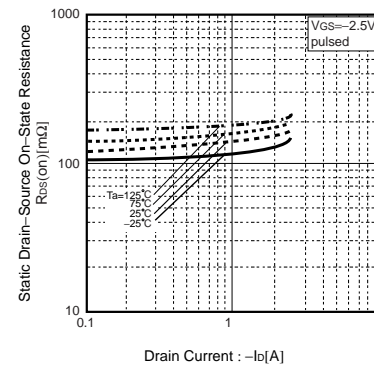

Fig.5 Static Drain-Source On-State Resistance vs. Drain Current

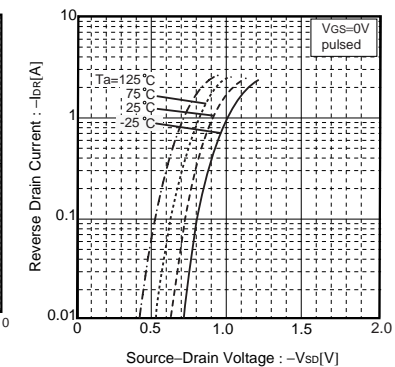

Fig.6 Reverse Drain Current vs. Source-Drain Voltage

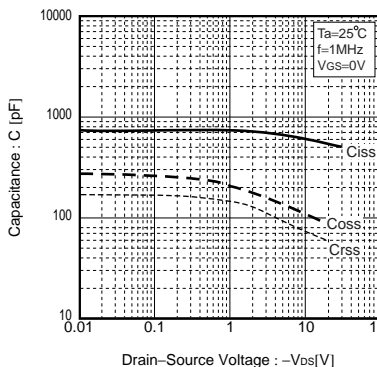

Fig.7 Typical Capacitance vs. Drain-Source Voltage

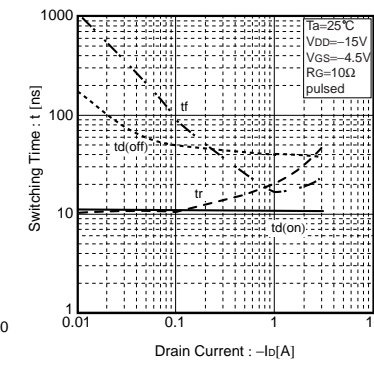

Fig.8 Switching Characteristics

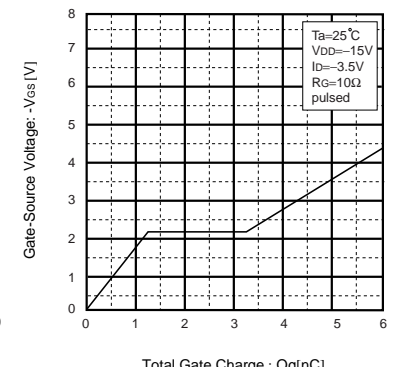

Fig.9 Dynamic Input Characteristics

Transistor

●Measurement circuits

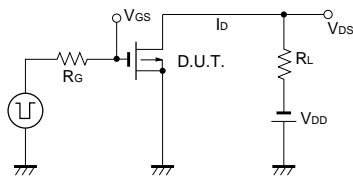

Fig.10 Switching Time Measurement Circuit

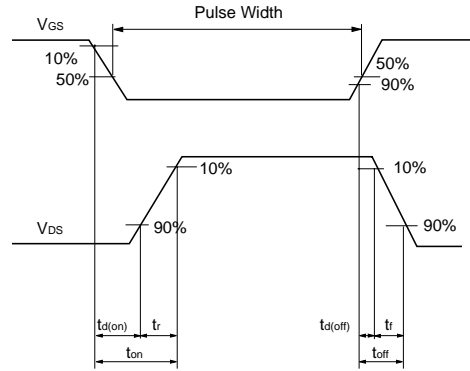

Fig.11 Switching Waveforms

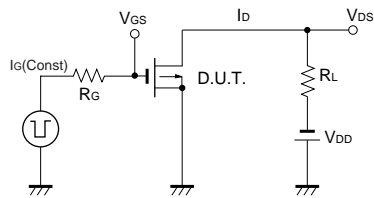

Fig.12 Gate Charge Measurement Circuit

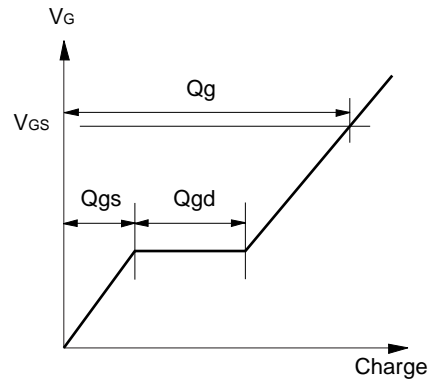

Fig.13 Gate Charge Waveforms

[www.s-manuals.com](http://www.s-manuals.com)