

# DC-DC Converter (-20V, -3.0A)

## RTQ030P02

### ●Features

- 1) Low On-resistance.(110mΩ at 2.5V)
- 2) High Power Package.
- 3) High speed switching.
- 4) Low voltage drive.(2.5V)

### ●Applications

DC-DC converter

### ●Structure

Silicon P-channel  
MOSFET

### ●Packaging specifications

Type	Package	Taping
	Code	TR
	Basic ordering unit (pieces)	3000
RTQ030P02		○

### ●External dimensions (Units : mm)

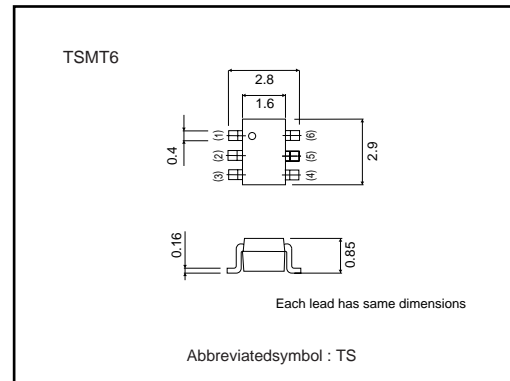

### ●Equivalent circuit

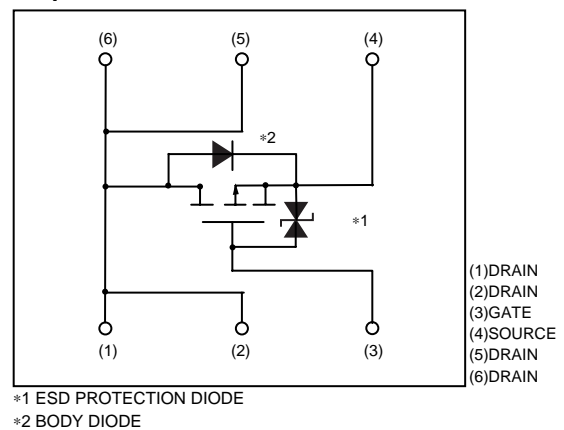

## Transistor

## ●Absolute maximum ratings (Ta=25°C)

Parameter	Symbol	Limits	Unit
Drain-source voltage	V <sub>DSS</sub>	-20	V
Gate-source voltage	V <sub>GSS</sub>	±12	V
Drain current	Continuous	I <sub>D</sub>	±3 A
	Pulsed	I <sub>DP</sub>	±12 A *1
Source current (Body diode)	Continuous	I <sub>S</sub>	-1 A
	Pulsed	I <sub>SP</sub>	-4 A *1
Total power dissipation	P <sub>D</sub>	1.25	W*2
Channel temperature	T <sub>ch</sub>	150	°C
Range of Storage temperature	T <sub>stg</sub>	-55~+150	°C

\*1 P<sub>w</sub>≤10μs, Duty cycle≤1%

\*2 Mounted on a ceramic board

## ●Electrical characteristics (Ta=25°C)

Parameter	Symbol	Min.	Typ.	Max.	Unit	Conditions
Gate-source leakage	I <sub>GSS</sub>	-	-	±10	μA	V <sub>GS</sub> =±12V, V <sub>DS</sub> =0V
Drain-source breakdown voltage	V <sub>(BR)DSS</sub>	-20	-	-	V	I <sub>D</sub> =-1mA, V <sub>GS</sub> =0V
Zero gate voltage drain current	I <sub>DSS</sub>	-	-	-1	μA	V <sub>DS</sub> =-20V, V <sub>GS</sub> =0V
Gate threshold voltage	V <sub>GS(th)</sub>	-0.7	-	-2.0	V	V <sub>DS</sub> =-10V, I <sub>D</sub> =-1mA
Static drain-source on-state resistance	R <sub>DS(on)</sub> * <sup>†</sup>	-	60	80	mΩ	I <sub>D</sub> =-3A, V <sub>GS</sub> =-4.5V
		-	65	90	mΩ	I <sub>D</sub> =-3A, V <sub>GS</sub> =-4V
		-	110	150	mΩ	I <sub>D</sub> =-1.5A, V <sub>GS</sub> =-2.5V
Forward transfer admittance	Y <sub>fs</sub>  * <sup>†</sup>	2.0	-	-	S	V <sub>DS</sub> =-10V, I <sub>D</sub> =-1.5A
Input capacitance	C <sub>iss</sub>	-	800	-	pF	V <sub>DS</sub> =-10V, V <sub>GS</sub> =0V f=1MHz
Output capacitance	C <sub>oss</sub>	-	150	-	pF	
Reverse transfer capacitance	C <sub>rss</sub>	-	100	-	pF	
Turn-on delay time	t <sub>d(on)</sub> * <sup>†</sup>	-	15	-	ns	I <sub>D</sub> =-1.5A V <sub>DD</sub> =-15V V <sub>GS</sub> =-4.5V R <sub>L</sub> =10Ω R <sub>GS</sub> =10Ω
Rise time	t <sub>r</sub> * <sup>†</sup>	-	27	-	ns	
Turn-off delay time	t <sub>d(off)</sub> * <sup>†</sup>	-	50	-	ns	
Fall time	t <sub>f</sub> * <sup>†</sup>	-	20	-	ns	
Total gate charge	Q <sub>g</sub>	-	9.0	-	nC	V <sub>DD</sub> =-15V V <sub>GS</sub> =-4.5V I <sub>D</sub> =-3A
Gate-source charge	Q <sub>gs</sub>	-	1.6	-	nC	
Gate-drain charge	Q <sub>gd</sub>	-	4.6	-	nC	
*PULSED						
Body diode characteristics (source-drain characteristics)						
Forward voltage	V <sub>SD</sub>	-	-	-1.2	V	I <sub>S</sub> =-1A, V <sub>GS</sub> =0V

Transistor

●Electrical characteristic curves

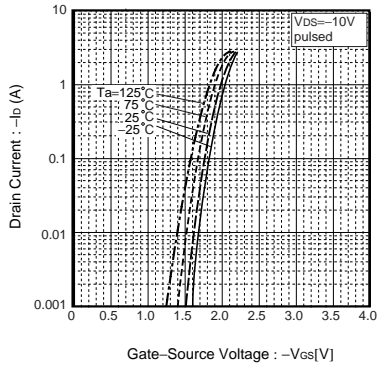

Fig.1 Typical Transfer Characteristics

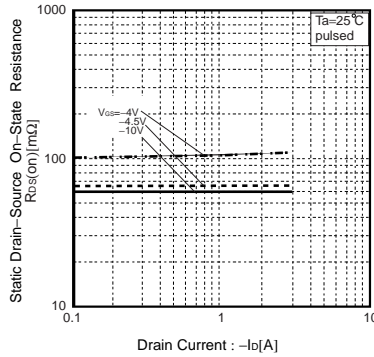

Fig.2 Static Drain-Source On-State Resistance vs. Drain Current

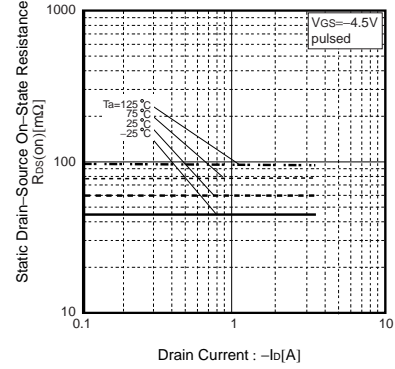

Fig.3 Static Drain-Source On-State Resistance vs. Drain Current

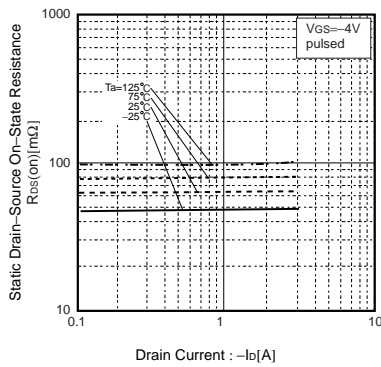

Fig.4 Static Drain-Source On-State Resistance vs. Drain Current

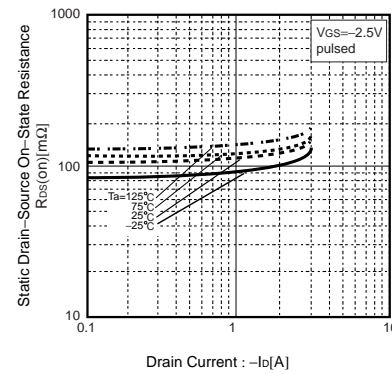

Fig.5 Static Drain-Source On-State Resistance vs. Drain Current

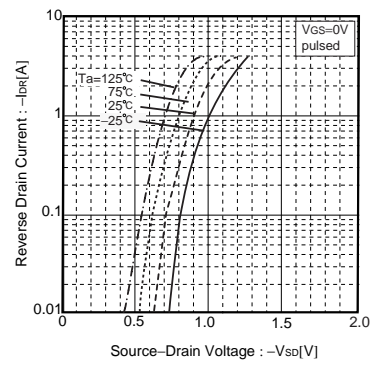

Fig.6 Reverse Drain Current vs. Source-Drain Voltage

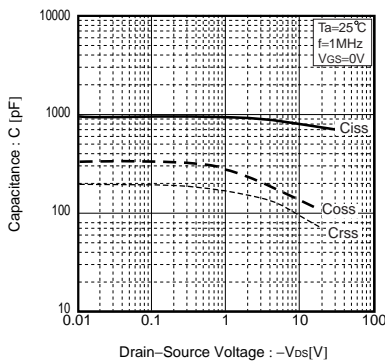

Fig.7 Typical Capacitance vs. Drain-Source Voltage

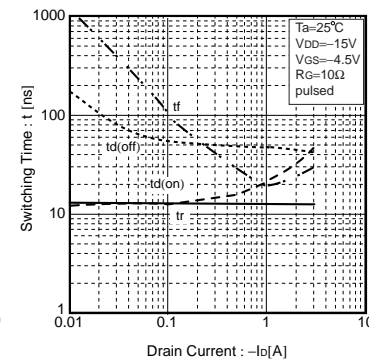

Fig.8 Switching Characteristics

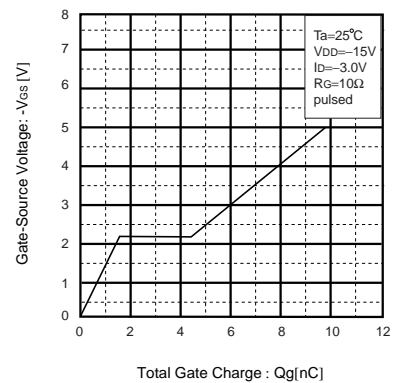

Fig.9 Dynamic Input Characteristics

Transistor

●Measurement circuits

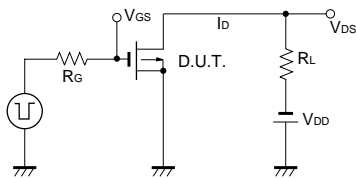

Fig.10 Switching Time Measurement Circuit

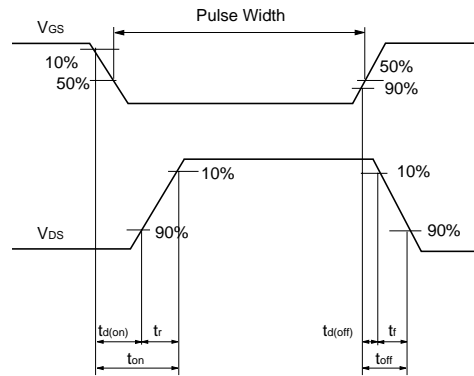

Fig.11 Switching Waveforms

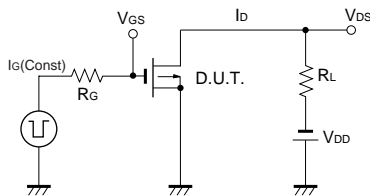

Fig.12 Gate Charge Measurement Circuit

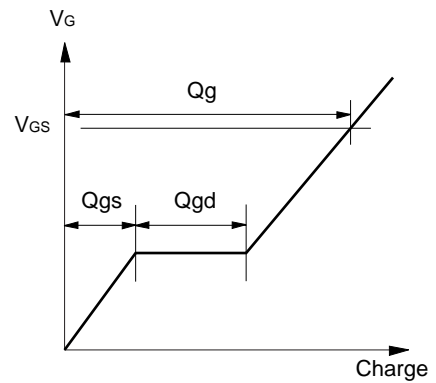

Fig.13 Gate Charge Waveforms

[www.s-manuals.com](http://www.s-manuals.com)