

NPN Silicon Epitaxial Planar Transistor

S9016

FEATURES

- Collector Current.($I_C=25\text{mA}$)
- Power dissipation.($P_C=200\text{mW}$)



APPLICATIONS

- AM converter, FM/RM amplifier of low noise.

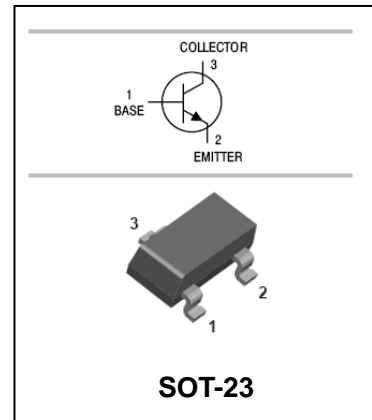

ORDERING INFORMATION

Type No.	Marking	Package Code
S9016	Y6	SOT-23

MAXIMUM RATING @ $T_a=25^\circ\text{C}$ unless otherwise specified

Symbol	Parameter	Value	Units
V_{CBO}	Collector-Base Voltage	30	V
V_{CEO}	Collector-Emitter Voltage	20	V
V_{EBO}	Emitter-Base Voltage	4	V
I_C	Collector Current -Continuous	25	mA
P_C	Collector Dissipation	200	mW
T_j, T_{stg}	Junction and Storage Temperature	-55~150	$^\circ\text{C}$

NPN Silicon Epitaxial Planar Transistor

S9016

ELECTRICAL CHARACTERISTICS @ Ta=25°C unless otherwise specified

Parameter	Symbol	Test conditions	MIN	TYP	MAX	UNIT
Collector-base breakdown voltage	$V_{(BR)CBO}$	$I_C=100\mu A, I_E=0$	30			V
Collector-emitter breakdown voltage	$V_{(BR)CEO}$	$I_C=0.1mA, I_B=0$	20			V
Emitter-base breakdown voltage	$V_{(BR)EBO}$	$I_E=100\mu A, I_C=0$	4			V
Collector cut-off current	I_{CBO}	$V_{CB}=30V, I_E=0$			0.1	μA
Emitter cut-off current	I_{EBO}	$V_{EB}=3V, I_C=0$			0.1	μA
DC current gain	h_{FE}	$V_{CE}=5V, I_C=1mA$	28	90	198	
Collector-emitter saturation voltage	$V_{CE(sat)}$	$I_C=10mA, I_B=1mA$		0.1	0.3	V
Base-emitter on voltage	$V_{BE(on)}$	$V_{CE}=5V, I_C=1mA$		0.72		V
Transition frequency	f_T	$V_{CE}=5V, I_C=1mA$	400	620		MHz
Output capacitance	C_{ob}	$V_{CB}=10V, I_E=0, f=1MHz$		1.2	1.6	pF
Noise figure	NF	$V_{CE}=5V, I_C=1.0, f=100MHz, R_S=50\Omega$		1.2	1.6	pF

TYPICAL CHARACTERISTICS @ Ta=25°C unless otherwise specified

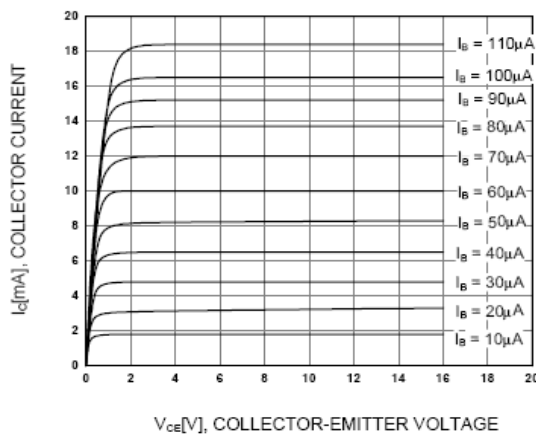

Figure 1. Static Characteristic

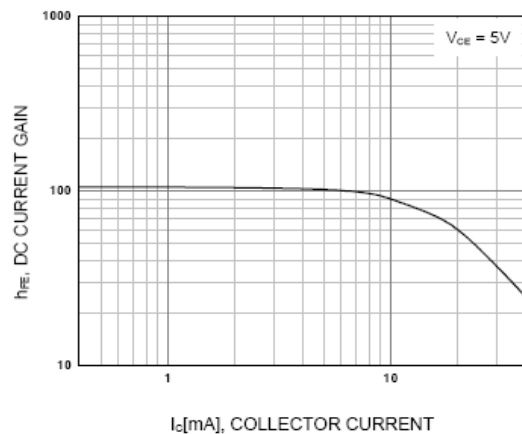
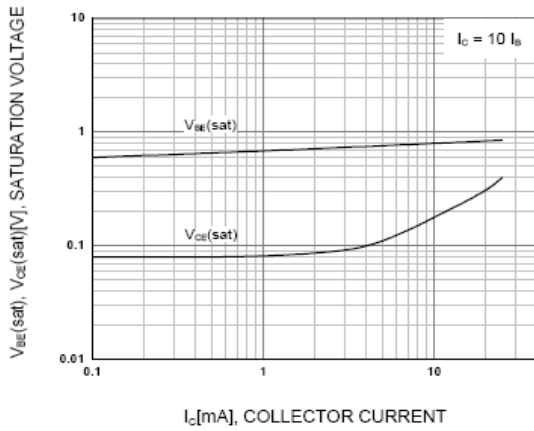

Figure 2. DC current Gain

NPN Silicon Epitaxial Planar Transistor

S9016



**Figure 3. Base-Emitter Saturation Voltage
Collector-Emmitter Saturation Voltage**

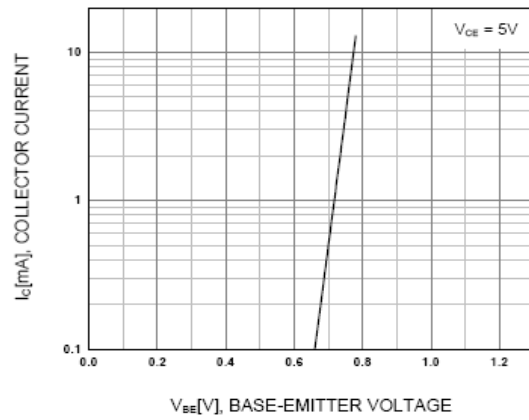

Figure 4. Base-Emitter On Voltage

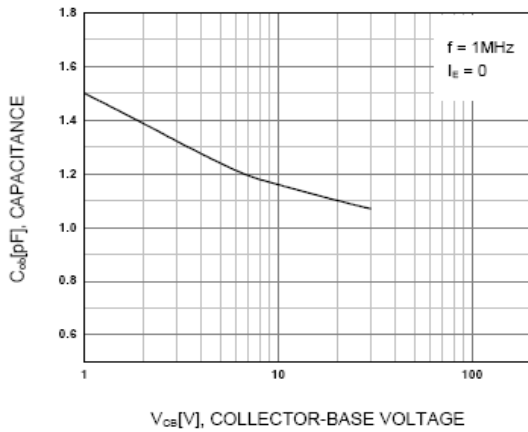

Figure 5. Collector Output Capacitance

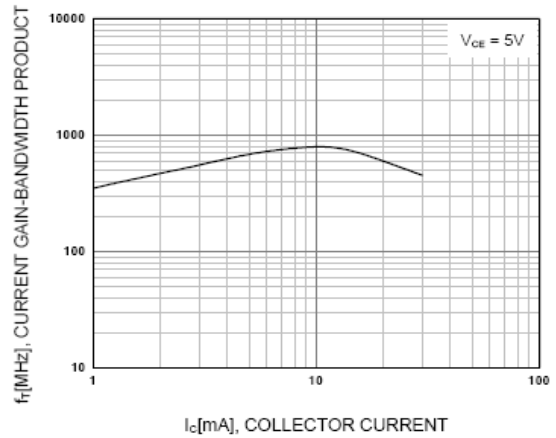

Figure 6. Current Gain Bandwidth Product

NPN Silicon Epitaxial Planar Transistor

S9016

PACKAGE OUTLINE

Plastic surface mounted package

SOT-23

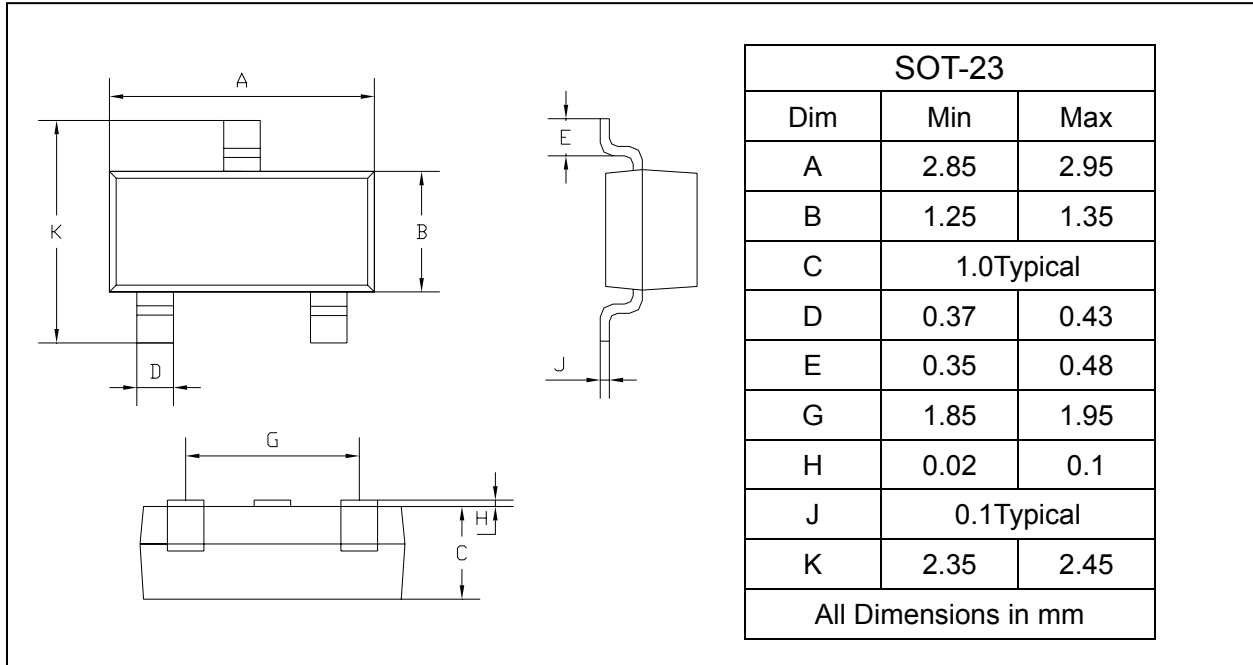

SOLDERING FOOTPRINT

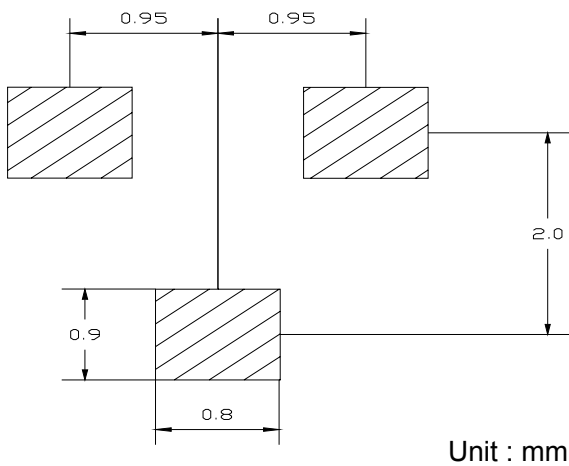

PACKAGE INFORMATION

Device	Package	Shipping
S9016	SOT-23	3000/Tape&Reel

www.s-manuals.com