

General Description

- SDBN500B01 is best suited for switching inductive loads in power switching applications. It improves efficiency and reliability of power switching systems and it can support continuous maximum current of 500 mA. It features NPN transistor with high breakdown voltage and discrete switching diode with high forward surge current. It reduces component count, consumes less space and minimizes parasitic losses. The component devices can be used as a part of a circuit or as a stand alone discrete device.

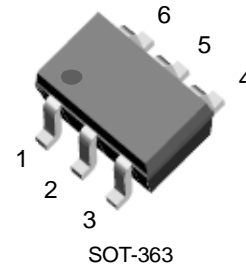

Features

- NPN Transistor with High Break-Down Voltage
- Switching Diode with High Forward Surge
- Low Switching and Conduction Losses
- Surface Mount Package Suited for Automated Assembly
- Lead Free By Design/RoHS Compliant (Note 1)
- "Green" Device (Note 2)

Mechanical Data

- Case: SOT-363
- Case Material: Molded Plastic, "Green" Molding Compound. UL Flammability Classification Rating 94V-0
- Moisture Sensitivity: Level 1 per J-STD-020C
- Terminal Connections: See Figure
- Terminals: Finish — Matte Tin annealed over Alloy 42 leadframe. Solderable per MIL-STD-202, Method 208
- Marking and Type Code Information: See Page 6
- Ordering Information: See Page 6
- Weight: 0.016 grams (approximate)

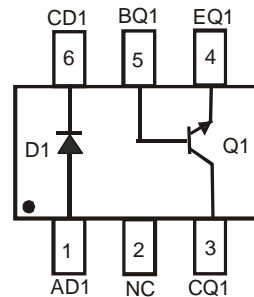

Schematic and Pin Configuration

Sub-Component P/N	Reference	Device Type
MMBTA06_DIE	Q1	NPN Transistor
BAS31_DIE	D1	Switching Diode

Maximum Ratings: Total Device @T_A = 25°C unless otherwise specified

Characteristic	Symbol	Value	Unit
Power Dissipation (Note 3)	P _d	200	mW
Power Derating Factor above 25°C	P _{der}	1.6	mW / °C
Output Current	I _{out}	500	mA

Thermal Characteristics

Characteristic	Symbol	Value	Unit
Junction Operating and Storage Temperature Range	T _j , T _{STG}	-55 to +150	°C
Thermal Resistance, Junction to Ambient Air (Note 3) (Equivalent to One Heated Junction of NPN Transistor)	R _{θJA}	625	°C/W

- Notes:
- No purposefully added lead.
 - Diodes Inc.'s "Green" policy can be found on our website at http://www.diodes.com/products/lead_free/index.php.
 - Device mounted on FR-4 PCB, 1" x 0.85" x 0.062"; pad layout as shown on Diodes Inc. suggested pad layout document AP02001, which can be found on our website at <http://www.diodes.com/datasheets/ap02001.pdf>.

Maximum Ratings:

Sub-Component Device – Switching Diode (D1) @T_A = 25°C unless otherwise specified

Characteristic	Symbol	Value	Unit	
Non-Repetitive Peak Reverse Voltage	V _{RM}	100	V	
Peak Repetitive Reverse Voltage	V _{RRM}	75	V	
Working Peak Reverse Voltage	V _{RWM}			
DC Blocking Voltage	V _R			
RMS Reverse Voltage	V _{R(RMS)}	53	V	
Forward Continuous Current (Page 1: Note 3)	I _{FM}	500	mA	
Average Rectified Output Current (Page 1: Note 3)	I _O	250	mA	
Non-Repetitive Peak Forward Surge Current	I _{FSM}	@ t = 1.0 us	4	A
		@ t = 1.0 s	2	A

Sub Component Device - Discrete NPN Transistor (Q1) @T_A = 25°C unless otherwise specified

Characteristic	Symbol	Value	Unit
Collector-Base Voltage	V _{CBO}	80	V
Collector-Emitter Voltage	V _{CEO}	80	V
Emitter-Base Voltage	V _{EBO}	4	V
Output Current - continuous (Page 1: Note 3)	I _C	500	mA

Electrical Characteristics:

Switching Diode (D1) @T_A = 25°C unless otherwise specified

Characteristic	Symbol	Min	Typ	Max	Unit	Test Condition
Reverse Breakdown Voltage (Note 4)	V _{(BR)R}	75	—	—	V	I _R = 10 μA
Forward Voltage Drop (Note 4)	V _{FM}	0.62	—	0.37	V	I _F = 5 mA
		—	—	0.855		I _F = 10 mA
		—	—	1		I _F = 100 mA
		—	—	1.25		I _F = 150 mA
Reverse Current (Note 4)	I _R	—	—	2.5	μA	V _R = 75V
		—	—	50		V _R = 75V, T _j = 150 °C
		—	—	30		V _R = 25V, T _j = 150 °C
		—	—	25		V _R = 20V
Total Capacitance	C _T	—	—	4	pF	V _R = 0V, f = 1.0 MHz
Reverse Recovery Time	t _{rr}	—	—	4	ns	I _F = I _R = 10mA, I _{rr} = 0.1xI _R , R _L = 100 Ω

Notes: 4. Short duration pulse test used to minimize self-heating effect.

Discrete NPN Transistor (Q1) @ $T_A = 25^\circ\text{C}$ unless otherwise specified

Characteristic	Symbol	Min	Max	Unit	Test Condition
OFF CHARACTERISTICS (Note 4)					
Collector-Base Breakdown Voltage	$V_{BR(CBO)}$	80	—	V	$I_C = 10 \mu\text{A}, I_E = 0$
Collector-Emitter Breakdown Voltage	$V_{BR(CEO)}$	80	—	V	$I_C = 1.0 \text{ mA}, I_B = 0$
Emitter-Base Breakdown Voltage	$V_{(BR)EBO}$	4	—	V	$I_E = 100 \mu\text{A}, I_C = 0$
Collector Cutoff Current	I_{CEX}	—	100	nA	$V_{CE} = 60\text{V}, V_{EB(OFF)} = 3.0\text{V}$
Base Cutoff Current (I_{BEX})	I_{BL}	—	100	nA	$V_{CE} = 60\text{V}, V_{EB(OFF)} = 3.0\text{V}$
Collector-Base Cut Off Current	I_{CBO}	—	100	nA	$V_{CB} = 80\text{V}, I_E = 0$
Collector-Emitter Cut Off Current, $I_{O(OFF)}$	I_{CEO}	—	100	nA	$V_{CE} = 80\text{V}, I_B = 0$
Emitter-Base Cut Off Current	I_{EBO}	—	100	nA	$V_{EB} = 5\text{V}, I_C = 0$
ON CHARACTERISTICS (Note 4)					
DC Current Gain	h_{FE}	60	—	—	$V_{CE} = 1\text{V}, I_C = 100 \mu\text{A}$
		80	—	—	$V_{CE} = 1\text{V}, I_C = 1 \text{ mA}$
		100	—	—	$V_{CE} = 1\text{V}, I_C = 10 \text{ mA}$
		100	—	—	$V_{CE} = 1\text{V}, I_C = 50 \text{ mA}$
		90	—	—	$V_{CE} = 1\text{V}, I_C = 100 \text{ mA}$
Collector-Emitter Saturation Voltage	$V_{CE(SAT)}$	—	0.1	V	$I_C = 10 \text{ mA}, I_B = 1 \text{ mA}$
		—	0.25	V	$I_C = 100 \text{ mA}, I_B = 10 \text{ mA}$
		—	0.35	V	$I_C = 200 \text{ mA}, I_B = 20 \text{ mA}$
Base-Emitter Turn-on Voltage	$V_{BE(ON)}$	—	0.98	V	$V_{CE} = 5\text{V}, I_C = 2 \text{ mA}$
Base-Emitter Saturation Voltage	$V_{BE(SAT)}$	—	0.95	V	$I_C = 10 \text{ mA}, I_B = 1 \text{ mA}$
		—	1.2	V	$I_C = 100 \text{ mA}, V_{CE} = 1\text{V}$
SMALL SIGNAL CHARACTERISTICS					
Output Capacitance	C_{OBO}	—	4	pF	$V_{CB} = 5.0 \text{ V}, f = 1.0\text{MHz}, I_E = 0$
Input Capacitance	C_{IBO}	—	6	pF	$V_{EB} = 5.0 \text{ V}, f = 1.0\text{MHz}, I_C = 0$
Current Gain-Bandwidth Product	f_T	100	—	MHz	$V_{CE} = 2 \text{ V}, I_C = 10\text{mA}, f = 100\text{MHz}$
SWITCHING CHARACTERISTICS					
Delay Time	t_d	—	35	ns	$V_{CC} = 3.0 \text{ V}, I_C = 10\text{mA}$
Rise Time	t_r	—	35	ns	$V_{BE(OFF)} = 0.5\text{V}, I_{B1} = 1.0\text{mA}$

Pulse Test: Pulse width, $t_p < 300\mu\text{s}$, Duty Cycle, $d \leq 2\%$

Notes: 4. Short duration pulse test used to minimize self-heating effect.

Typical Characteristics

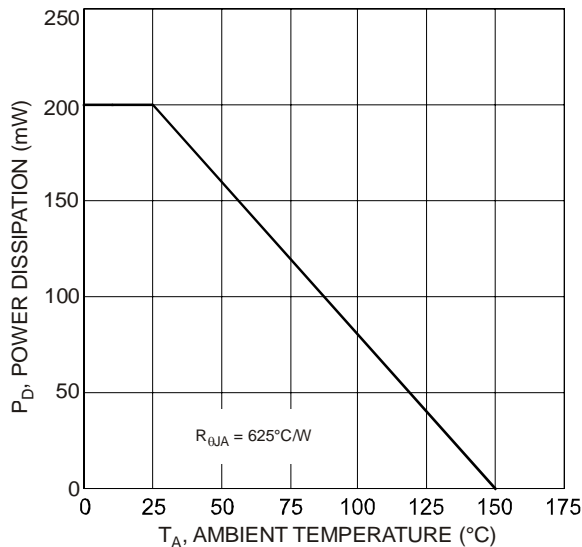
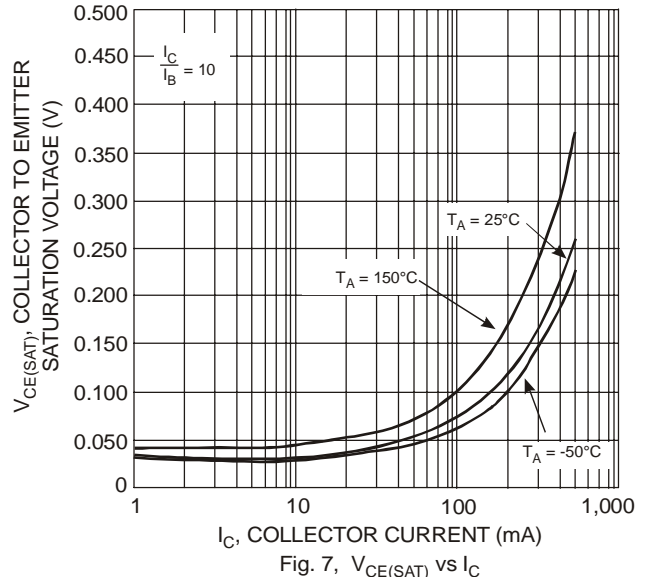
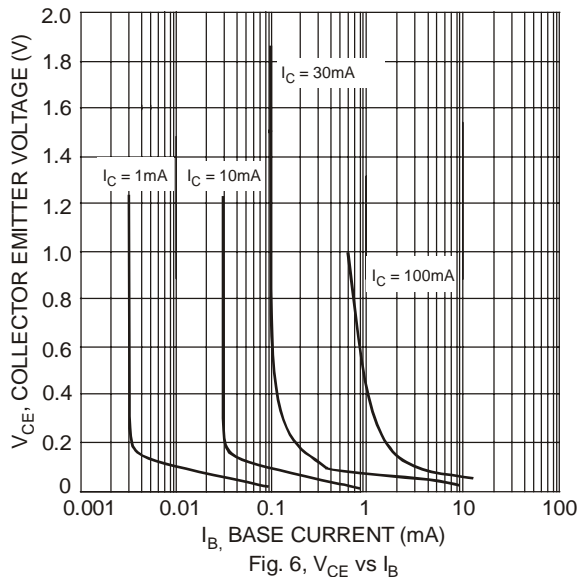
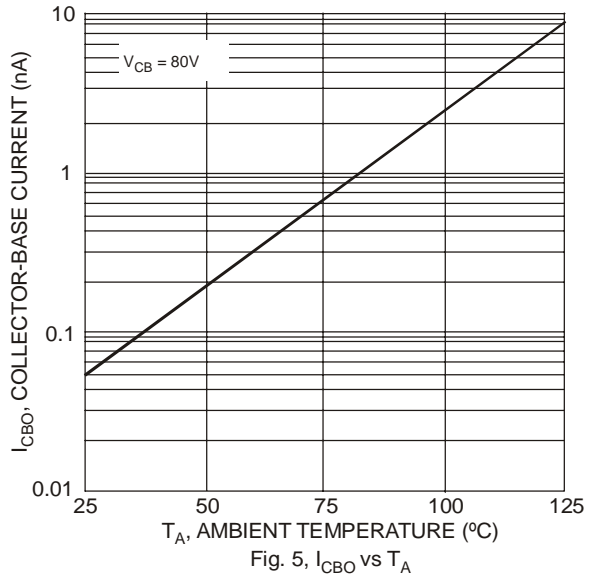
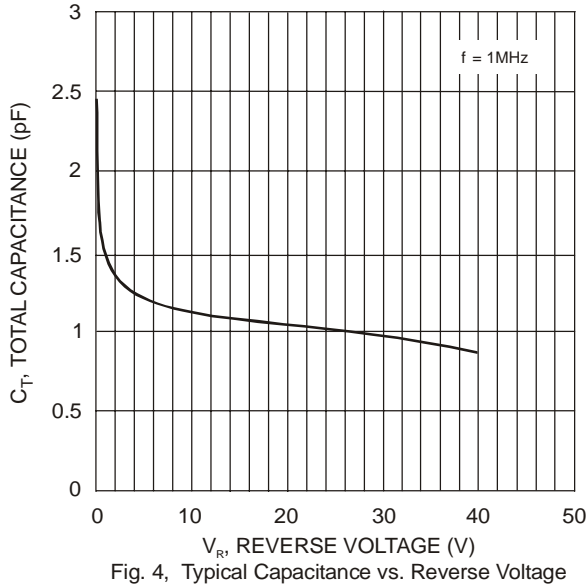
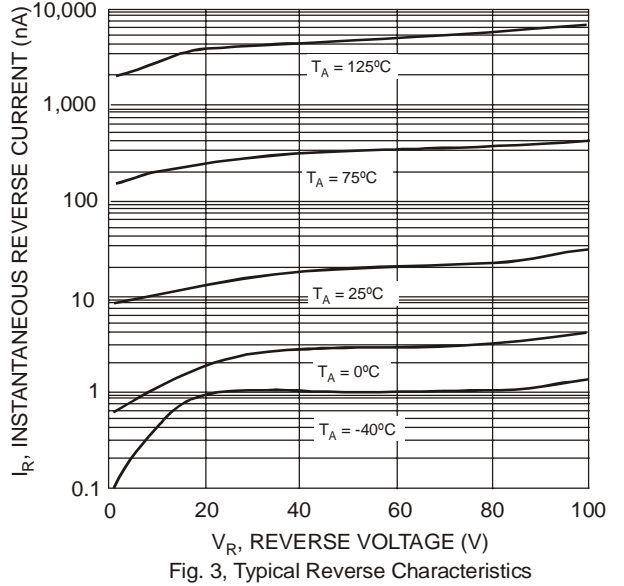
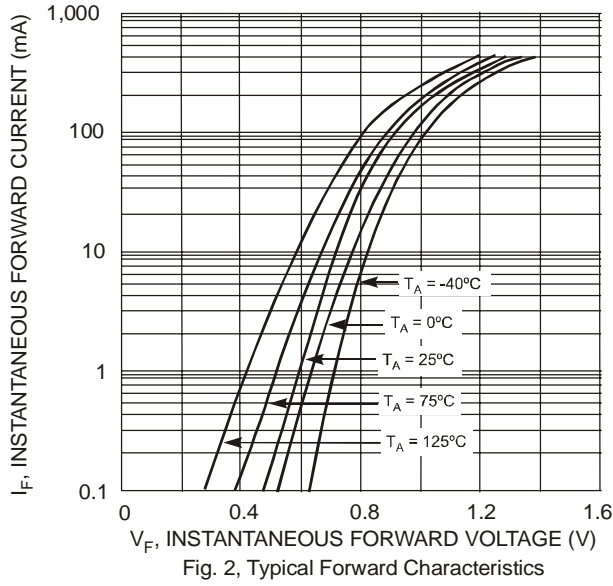

Fig. 1, Maximum Power Dissipation vs. Ambient Temperature

Switching Diode (D1) Characteristics



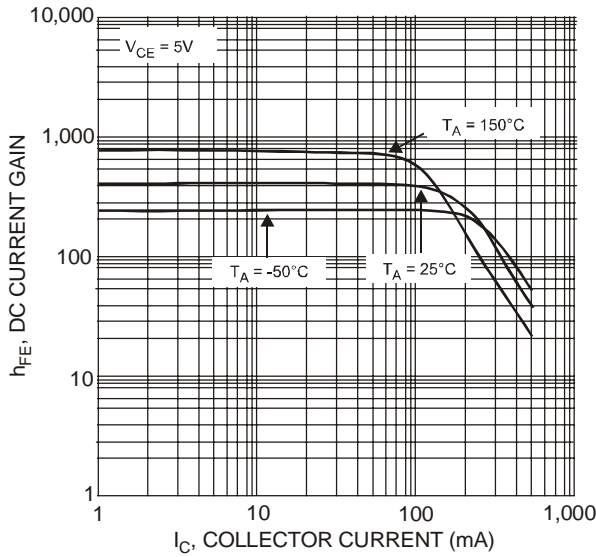

Fig. 8, h_{FE} vs I_C

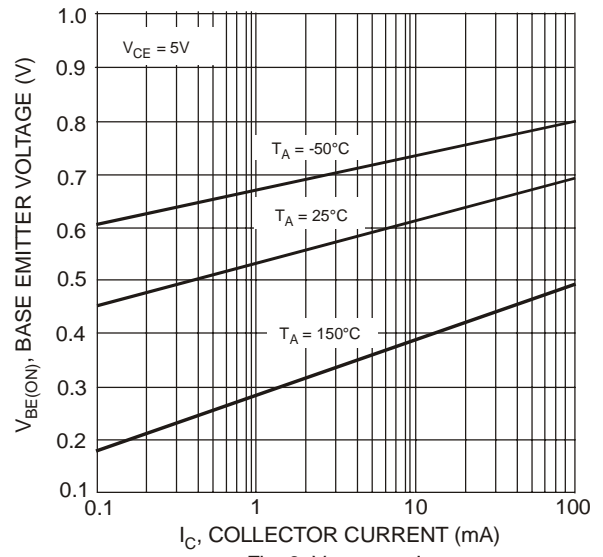

Fig. 9, $V_{BE(ON)}$ vs I_C

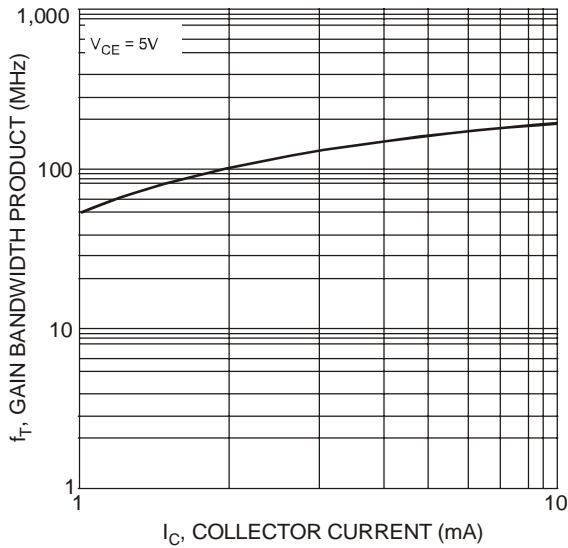

Fig. 10, f_T vs I_C

Application Details:

NPN transistor (MMBTA06) and Switching diode (BAV70) integrated as one in SDBN500B01 can be used as a discrete entity for general applications or part of a circuit to function as low side switch for sinking current. NPN is selected based on high break-down voltage and maximum collector current range. Switching diode is selected based on instantaneous forward surge current. The Switching diode dissipates very little power because it is on for only a small portion of the switching cycle. It is designed to replace the discrete NPN transistor and a Switching diode in two separate packages into one small package as shown in Figure. It consumes less board space and also helps to minimize conduction or switching losses due to parasitic inductances (e.g. PCB traces) in power switch applications. (Please see Fig. 11 for one example of typical application circuit used in conjunction with DC-DC converter as a part of the power management system).

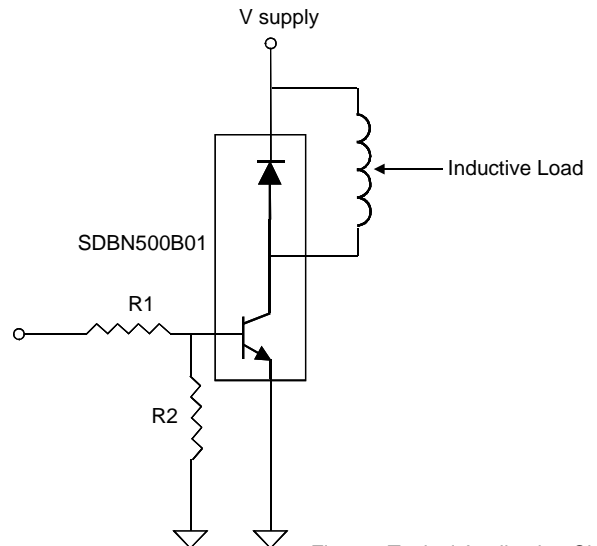

Fig. 11, Typical Application Circuit

Ordering Information (Note 5)

Device	Marking Code	Packaging	Shipping
SDBN500B01-7	RD07	SOT-363	3000/Tape & Reel

Notes: 5. For packaging details, please see below or go to our website at <http://www.diodes.com/datasheets/ap02007.pdf>.

Marking Information

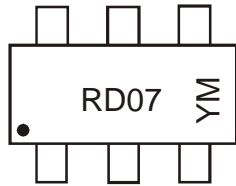

RD07 = Product Type Marking Code,
 YM = Date Code Marking
 Y = Year e.g. T = 2006
 M = Month e.g. 9 = September

Date Code Key

Year	2006	2007	2008	2009	2010	2011	2012
Code	T	U	V	W	X	Y	Z

Month	Jan	Feb	Mar	Apr	May	Jun	Jul	Aug	Sep	Oct	Nov	Dec
Code	1	2	3	4	5	6	7	8	9	O	N	D

Mechanical Details

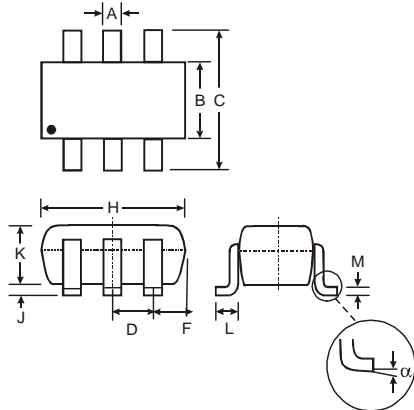

SOT-363		
Dim	Min	Max
A	0.10	0.30
B	1.15	1.35
C	2.00	2.20
D	0.65 Nominal	
F	0.30	0.40
H	1.80	2.20
J	-	0.10
K	0.90	1.00
L	0.25	0.40
M	0.10	0.25
α	0°	8°
All Dimensions in mm		

Suggested Pad Layout: (Based on IPC-SM-782)

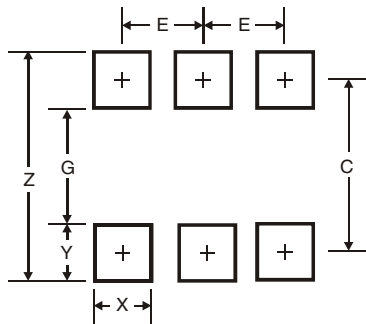

Dimensions	Value
Z	2.5
G	1.3
X	0.42
Y	0.6
C	1.9
E	0.65
All Dimensions in mm	

IMPORTANT NOTICE

Diodes Incorporated and its subsidiaries reserve the right to make modifications, enhancements, improvements, corrections or other changes without further notice to any product herein. Diodes Incorporated does not assume any liability arising out of the application or use of any product described herein; neither does it convey any license under its patent rights, nor the rights of others. The user of products in such applications shall assume all risks of such use and will agree to hold Diodes Incorporated and all the companies whose products are represented on our website, harmless against all damages.

LIFE SUPPORT

Diodes Incorporated products are not authorized for use as critical components in life support devices or systems without the expressed written approval of the President of Diodes Incorporated.

www.s-manuals.com