

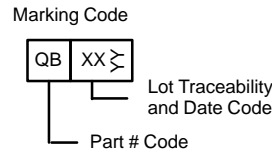

## Dual P-Channel 1.8-V (G-S) MOSFET

**TrenchFET<sup>®</sup>**  
Power MOSFETs  
1.8-V Rated

PRODUCT SUMMARY		
V <sub>DS</sub> (V)	r <sub>DS(on)</sub> (Ω)	I <sub>D</sub> (A)
-8	0.600 @ V <sub>GS</sub> = -4.5 V	±0.60
	0.850 @ V <sub>GS</sub> = -2.5 V	±0.50
	1.200 @ V <sub>GS</sub> = -1.8 V	±0.42

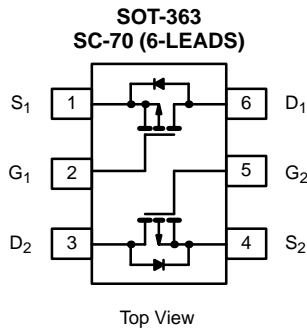

ABSOLUTE MAXIMUM RATINGS (T <sub>A</sub> = 25°C UNLESS OTHERWISE NOTED)					
Parameter	Symbol	5 secs	Steady State	Unit	
Drain-Source Voltage	V <sub>DS</sub>	-8		V	
Gate-Source Voltage	V <sub>GS</sub>	±8			
Continuous Drain Current (T <sub>J</sub> = 150°C) <sup>a</sup>	I <sub>D</sub>	T <sub>A</sub> = 25°C	±0.60	±0.57	A
		T <sub>A</sub> = 85°C	±0.43	±0.41	
Pulsed Drain Current	I <sub>DM</sub>	±1.0			
Continuous Diode Current (Diode Conduction) <sup>a</sup>	I <sub>S</sub>	-0.25	-0.23		
Maximum Power Dissipation <sup>a</sup>	P <sub>D</sub>	T <sub>A</sub> = 25°C	0.30	0.27	W
		T <sub>A</sub> = 85°C	0.16	0.14	
Operating Junction and Storage Temperature Range	T <sub>J</sub> , T <sub>stg</sub>	-55 to 150		°C	

THERMAL RESISTANCE RATINGS					
Parameter	Symbol	Typical	Maximum	Unit	
Maximum Junction-to-Ambient <sup>a</sup>	R <sub>thJA</sub>	t ≤ 5 sec	360	415	°C/W
		Steady State	400	460	
Maximum Junction-to-Foot (Drain)	R <sub>thJF</sub>	300	350		

Notes  
a. Surface Mounted on 1" x 1" FR4 Board.



**SPECIFICATIONS (T<sub>J</sub> = 25 °C UNLESS OTHERWISE NOTED)**

Parameter	Symbol	Test Condition	Min	Typ	Max	Unit
<b>Static</b>						
Gate Threshold Voltage	V <sub>GS(th)</sub>	V <sub>DS</sub> = V <sub>GS</sub> , I <sub>D</sub> = -250 μA	-0.45			V
Gate-Body Leakage	I <sub>GSS</sub>	V <sub>DS</sub> = 0 V, V <sub>GS</sub> = ±8 V			±100	nA
Zero Gate Voltage Drain Current	I <sub>DSS</sub>	V <sub>DS</sub> = -6.4 V, V <sub>GS</sub> = 0 V			-1	μA
		V <sub>DS</sub> = -6.4 V, V <sub>GS</sub> = 0 V, T <sub>J</sub> = 85 °C			-5	
On-State Drain Current <sup>a</sup>	I <sub>D(on)</sub>	V <sub>DS</sub> = -5 V, V <sub>GS</sub> = -4.5 V	-1.0			A
Drain-Source On-State Resistance <sup>a</sup>	r <sub>DS(on)</sub>	V <sub>GS</sub> = -4.5 V, I <sub>D</sub> = -0.57 A		0.51	0.600	Ω
		V <sub>GS</sub> = -2.5 V, I <sub>D</sub> = -0.48 A		0.720	0.850	
		V <sub>GS</sub> = -1.8 V, I <sub>D</sub> = -0.20 A		1.0	1.200	
Forward Transconductance <sup>a</sup>	g <sub>fs</sub>	V <sub>DS</sub> = -10 V, I <sub>D</sub> = -0.57 A		1.2		S
Diode Forward Voltage <sup>a</sup>	V <sub>SD</sub>	I <sub>S</sub> = -0.23 A, V <sub>GS</sub> = 0 V		-0.8	-1.2	V
<b>Dynamic<sup>b</sup></b>						
Total Gate Charge	Q <sub>g</sub>	V <sub>DS</sub> = -4 V, V <sub>GS</sub> = -4.5 V, I <sub>D</sub> = -0.57 A		1.5	2.3	nC
Gate-Source Charge	Q <sub>gs</sub>			0.17		
Gate-Drain Charge	Q <sub>gd</sub>			0.16		
Turn-On Delay Time	t <sub>d(on)</sub>	V <sub>DD</sub> = -4 V, R <sub>L</sub> = 8 Ω I <sub>D</sub> ≅ -0.5 A, V <sub>GEN</sub> = -4.5 V, R <sub>G</sub> = 6 Ω		6	12	ns
Rise Time	t <sub>r</sub>			25	50	
Turn-Off Delay Time	t <sub>d(off)</sub>			10	20	
Fall Time	t <sub>f</sub>			10	20	
Source-Drain Reverse Recovery Time	t <sub>rr</sub>	I <sub>F</sub> = -0.23 A, di/dt = 100 A/μs		20	40	

Notes

- a. Pulse test; pulse width ≤ 300 μs, duty cycle ≤ 2%.
- b. Guaranteed by design, not subject to production testing.

**TYPICAL CHARACTERISTICS (25 °C UNLESS NOTED)**

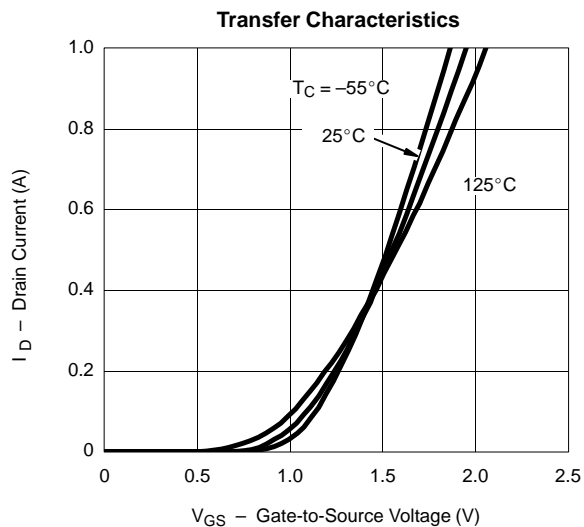
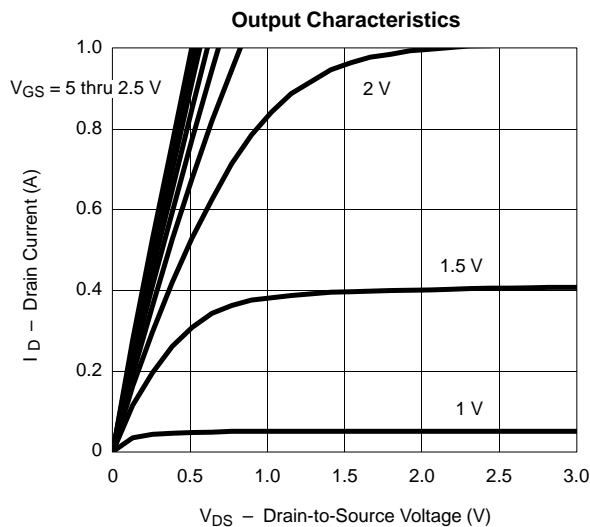



**TYPICAL CHARACTERISTICS (25°C UNLESS NOTED)**

On-Resistance vs. Drain Current

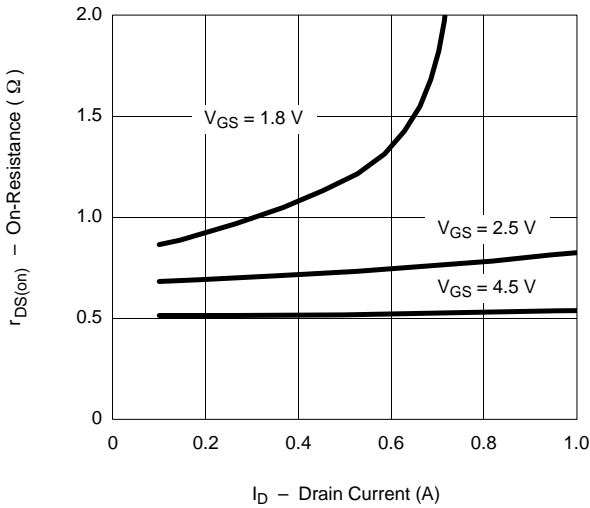

Capacitance

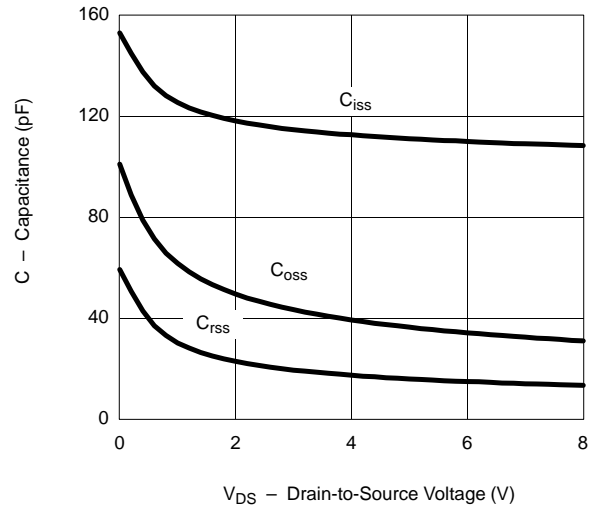

Gate Charge

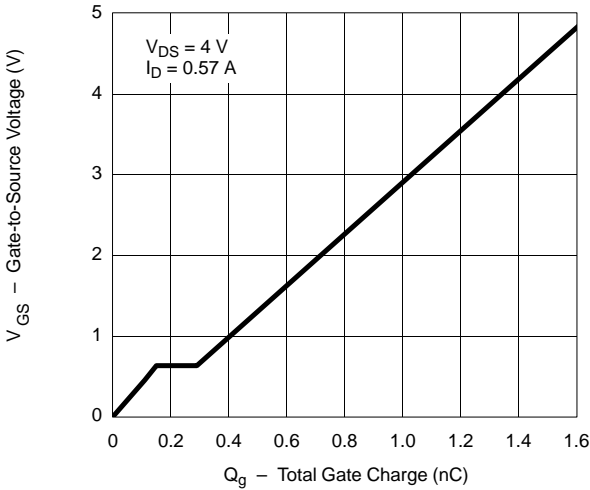

On-Resistance vs. Junction Temperature

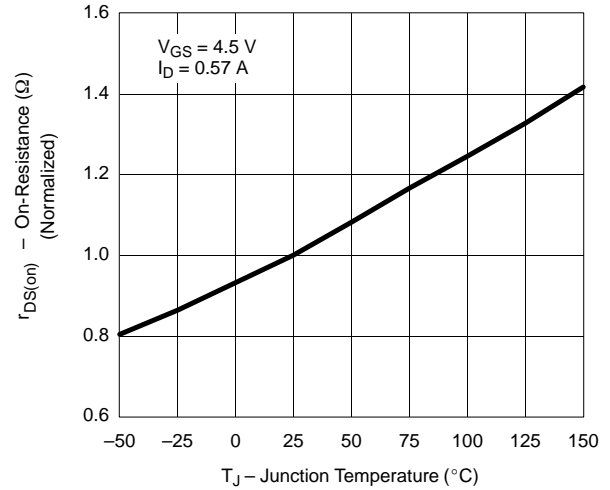

Source-Drain Diode Forward Voltage

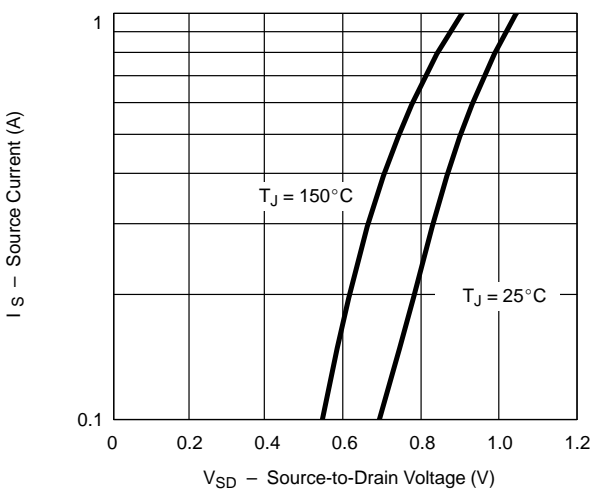

On-Resistance vs. Gate-to-Source Voltage

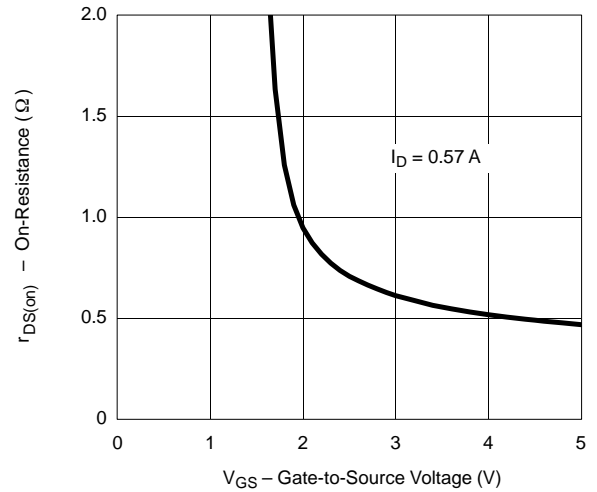



**TYPICAL CHARACTERISTICS (25°C UNLESS NOTED)**

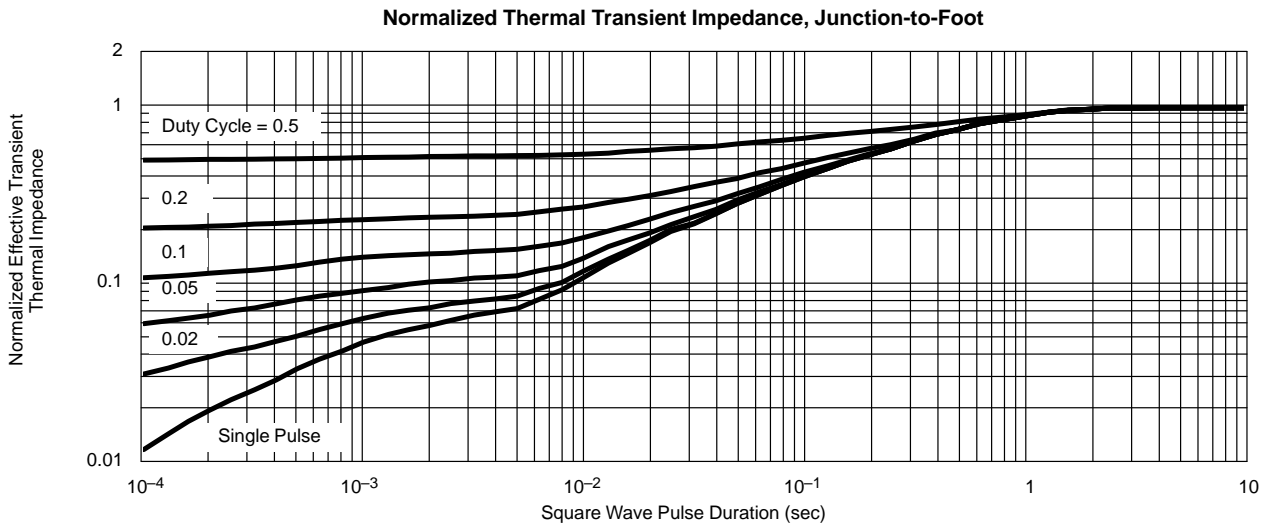
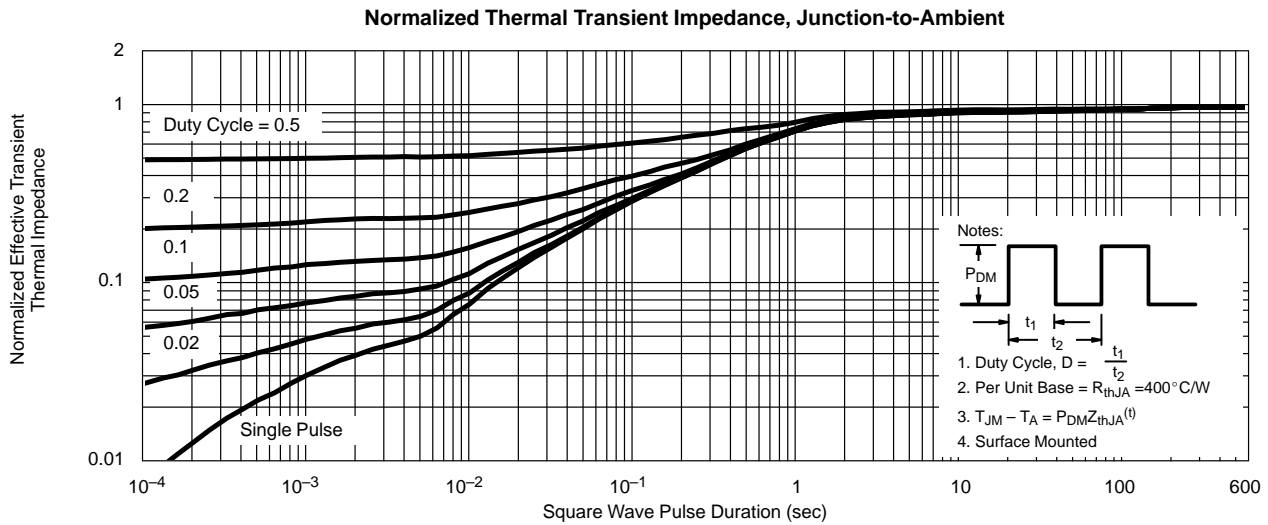
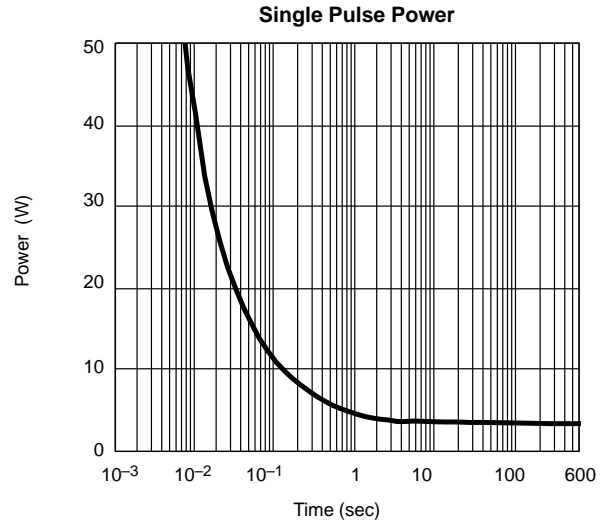
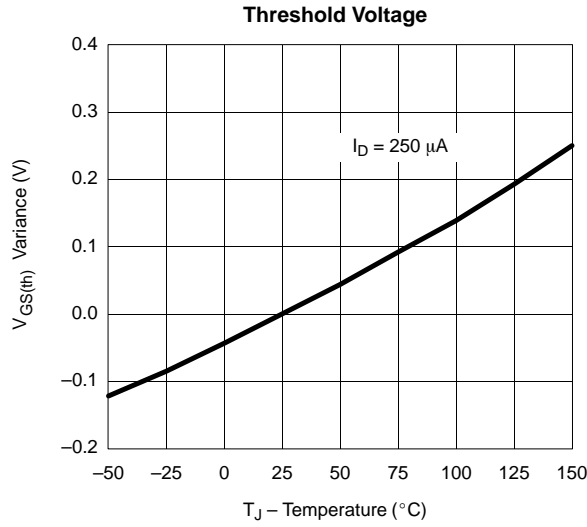



## Notice

Specifications of the products displayed herein are subject to change without notice. Vishay Intertechnology, Inc., or anyone on its behalf, assumes no responsibility or liability for any errors or inaccuracies.

Information contained herein is intended to provide a product description only. No license, express or implied, by estoppel or otherwise, to any intellectual property rights is granted by this document. Except as provided in Vishay's terms and conditions of sale for such products, Vishay assumes no liability whatsoever, and disclaims any express or implied warranty, relating to sale and/or use of Vishay products including liability or warranties relating to fitness for a particular purpose, merchantability, or infringement of any patent, copyright, or other intellectual property right.

The products shown herein are not designed for use in medical, life-saving, or life-sustaining applications. Customers using or selling these products for use in such applications do so at their own risk and agree to fully indemnify Vishay for any damages resulting from such improper use or sale.

[www.s-manuals.com](http://www.s-manuals.com)