

## Dual N-Channel 60-V (D-S) MOSFET

PRODUCT SUMMARY			
V <sub>DS</sub> (V)	r <sub>DS(on)</sub> (Ω)	I <sub>D</sub> (A)	Q <sub>g</sub> (Typ)
60	1.4 at V <sub>GS</sub> = 10 V	0.37	0.47
	3.0 at V <sub>GS</sub> = 4.5 V	0.25	

### FEATURES

- TrenchFET<sup>®</sup> Power MOSFET
- 100 % R<sub>g</sub> Tested
- ESD Protected: 1800 V



**RoHS**  
COMPLIANT

### APPLICATIONS

- Low Power Load Switch

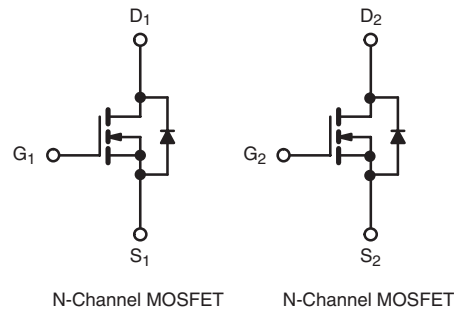
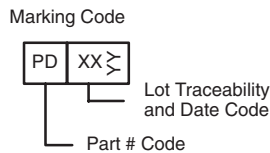
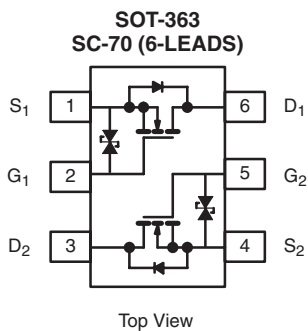

Ordering Information: Si1926DL-T1-E3 (Lead (Pb)-free)

ABSOLUTE MAXIMUM RATINGS T <sub>A</sub> = 25 °C, unless otherwise noted			
Parameter	Symbol	Limit	Unit
Drain-Source Voltage	V <sub>DS</sub>	60	V
Gate-Source Voltage	V <sub>GS</sub>	± 20	
Continuous Drain Current (T <sub>J</sub> = 150 °C)	I <sub>D</sub>	T <sub>C</sub> = 25 °C	0.37
		T <sub>C</sub> = 70 °C	0.30
		T <sub>A</sub> = 25 °C	0.34 <sup>b, c</sup>
		T <sub>A</sub> = 70 °C	0.27 <sup>b, c</sup>
Pulsed Drain Current	I <sub>DM</sub>	0.65	A
Continuous Source-Drain Diode Current	I <sub>S</sub>	T <sub>C</sub> = 25 °C	
		T <sub>A</sub> = 25 °C	0.25 <sup>b, c</sup>
Maximum Power Dissipation	P <sub>D</sub>	T <sub>C</sub> = 25 °C	0.51
		T <sub>C</sub> = 70 °C	0.33
		T <sub>A</sub> = 25 °C	0.30 <sup>b, c</sup>
		T <sub>A</sub> = 70 °C	0.20 <sup>b, c</sup>
Operating Junction and Storage Temperature Range	T <sub>J</sub> , T <sub>stg</sub>	- 55 to 150	°C

THERMAL RESISTANCE RATINGS				
Parameter	Symbol	Typical	Maximum	Unit
Maximum Junction-to-Ambient <sup>b, d</sup>	R <sub>thJA</sub>	360	415	°C/W
Maximum Junction-to-Foot (Drain)	R <sub>thJF</sub>	300	350	

Notes:

- Based on T<sub>C</sub> = 25 °C.
- Surface mounted on 1" x 1" FR4 board.
- t = 5 s.
- Maximum under Steady State conditions is 400 °C/W.

<b>SPECIFICATIONS</b> $T_J = 25\text{ }^\circ\text{C}$ , unless otherwise noted						
Parameter	Symbol	Test Conditions	Min	Typ	Max	Unit
<b>Static</b>						
Drain-Source Breakdown Voltage	$V_{DS}$	$V_{GS} = 0\text{ V}, I_D = 250\text{ }\mu\text{A}$	60			V
$V_{DS}$ Temperature Coefficient	$\Delta V_{DS}/T_J$	$I_D = 250\text{ }\mu\text{A}$		56.7		mV/ $^\circ\text{C}$
$V_{GS(th)}$ Temperature Coefficient	$\Delta V_{GS(th)}/T_J$			-3		
Gate-Source Threshold Voltage	$V_{GS(th)}$	$V_{DS} = V_{GS}, I_D = 250\text{ }\mu\text{A}$	1		2.5	V
Gate-Source Leakage	$I_{GSS}$	$V_{DS} = 0\text{ V}, V_{GS} = \pm 10\text{ V}$			$\pm 150$	nA
Zero Gate Voltage Drain Current	$I_{DSS}$	$V_{DS} = 60\text{ V}, V_{GS} = 0\text{ V}$			10	
		$V_{DS} = 60\text{ V}, V_{GS} = 0\text{ V}, T_J = 85\text{ }^\circ\text{C}$			100	
On-State Drain Current <sup>a</sup>	$I_{D(on)}$	$V_{DS} \geq 10\text{ V}, V_{GS} = 4.5\text{ V}$	0.50			A
		$V_{DS} \geq 7.5\text{ V}, V_{GS} = 10\text{ V}$	0.65			
Drain-Source On-State Resistance <sup>a</sup>	$r_{DS(on)}$	$V_{GS} = 10\text{ V}, I_D = 0.34$			1.4	$\Omega$
		$V_{GS} = 4.5\text{ V}, I_D = 0.23$			3	
Forward Transconductance	$g_{fs}$	$V_{DS} = 30\text{ V}, I_D = 0.2\text{ A}$		159		ms
<b>Dynamic<sup>b</sup></b>						
Input Capacitance	$C_{iss}$	$V_{DS} = 30\text{ V}, V_{GS} = 0\text{ V}, f = 1\text{ MHz}$		18.5		pF
Output Capacitance	$C_{oss}$			7.5		
Reverse Transfer Capacitance	$C_{rss}$			4.2		
Total Gate Charge	$Q_g$	$V_{DS} = 30\text{ V}, V_{GS} = 10\text{ V}, I_D = 0.34$		0.9	1.4	nC
				0.5	0.75	
Gate-Source Charge	$Q_{gs}$	$V_{DS} = 30\text{ V}, V_{GS} = 4.5\text{ V}, I_D = 0.34$		0.2		
Gate-Drain Charge	$Q_{gd}$			0.15		
Gate Resistance	$R_g$	$f = 1\text{ MHz}$		160	240	$\Omega$
Turn-On Delay Time	$t_{d(on)}$	$V_{DD} = 30\text{ V}, R_L = 100\text{ }\Omega$ $I_D \cong 0.3\text{ A}, V_{GEN} = 10\text{ V}, R_g = 1\text{ }\Omega$		6.5	10	ns
Rise Time	$t_r$			12	18	
Turn-Off Delay Time	$t_{d(off)}$			13	22	
Fall Time	$t_f$			14	21	
<b>Drain-Source Body Diode Characteristics</b>						
Continuous Source-Drain Diode Current	$I_S$	$T_C = 25\text{ }^\circ\text{C}$			0.43	A
Pulse Diode Forward Current <sup>a</sup>	$I_{SM}$				0.65	
Body Diode Voltage	$V_{SD}$	$I_S = 0.3\text{ A}$		0.8	1.2	V
Body Diode Reverse Recovery Time	$t_{rr}$	$I_F = 0.6\text{ A}, di/dt = 100\text{ A}/\mu\text{s}$		16.5	25	nC
Body Diode Reverse Recovery Charge	$Q_{rr}$			13	20	ns
Reverse Recovery Fall Time	$t_a$			13.5		
Reverse Recovery Rise Time	$t_b$			3		

## Notes:

- a. Pulse test; pulse width  $\leq 300\text{ }\mu\text{s}$ , duty cycle  $\leq 2\%$ .  
b. Guaranteed by design, not subject to production testing.

Stresses beyond those listed under "Absolute Maximum Ratings" may cause permanent damage to the device. These are stress ratings only, and functional operation of the device at these or any other conditions beyond those indicated in the operational sections of the specifications is not implied. Exposure to absolute maximum rating conditions for extended periods may affect device reliability.

**TYPICAL CHARACTERISTICS** 25 °C, unless otherwise noted

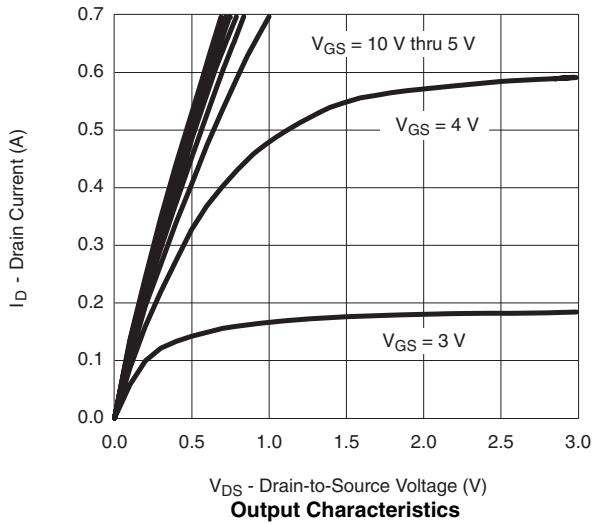

**Output Characteristics**

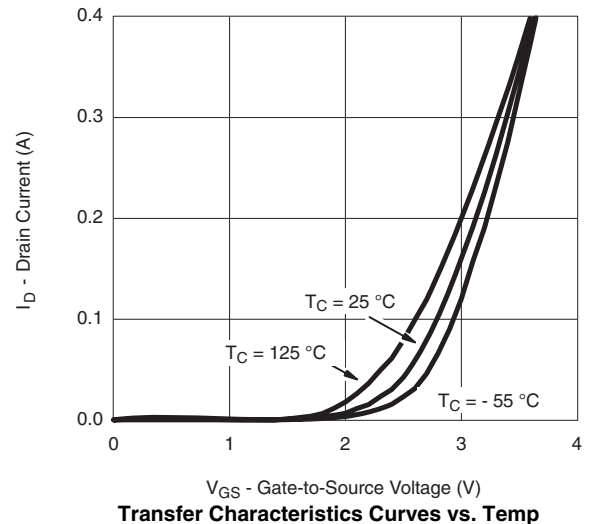

**Transfer Characteristics Curves vs. Temp**

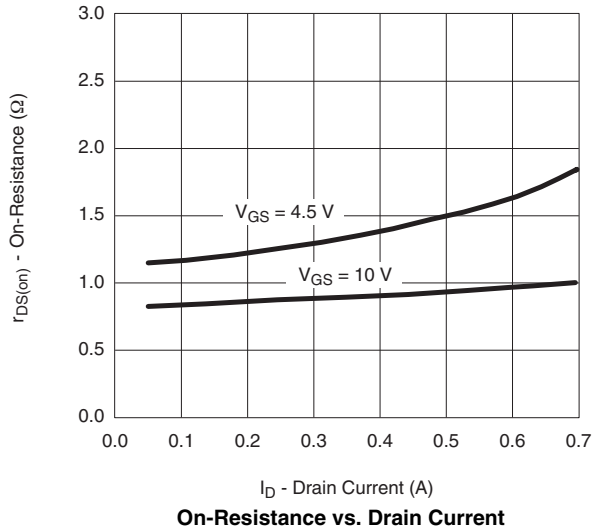

**On-Resistance vs. Drain Current**

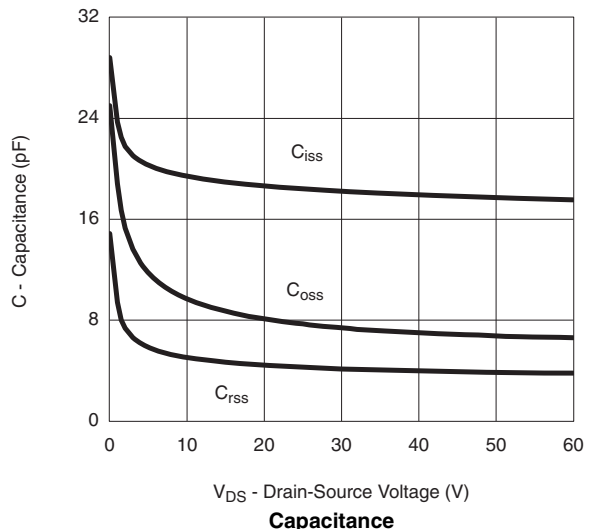

**Capacitance**

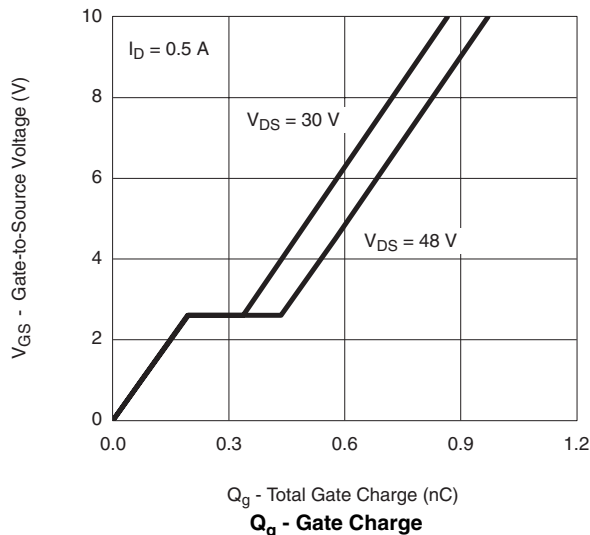

**Gate Charge**

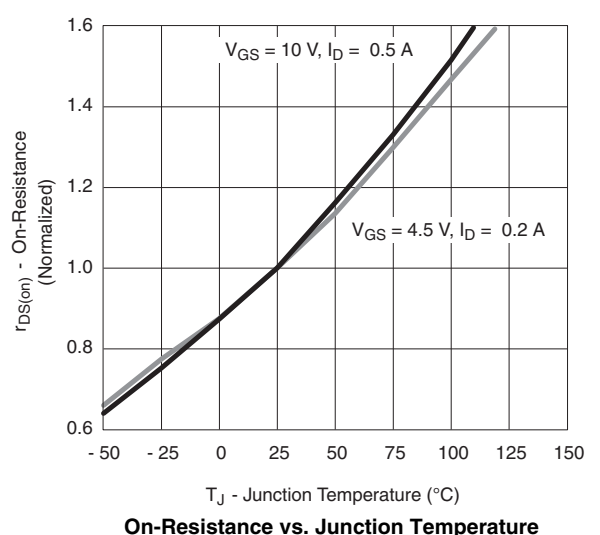

**On-Resistance vs. Junction Temperature**

**TYPICAL CHARACTERISTICS** 25 °C, unless otherwise noted

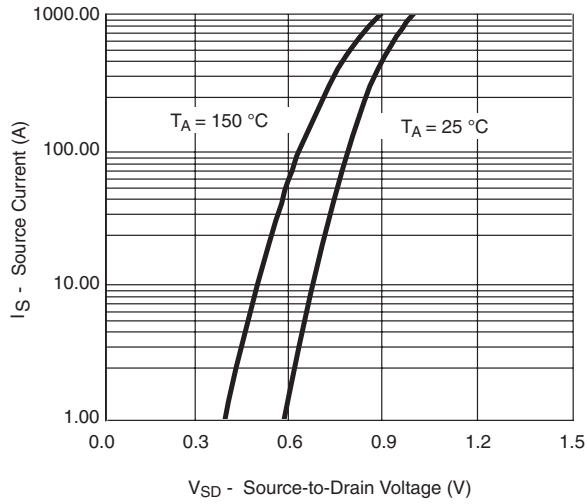

Source-Drain Diode Forward Voltage

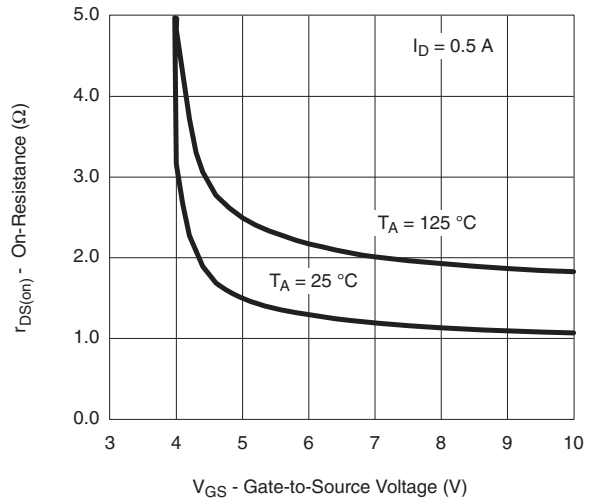

$r_{DS(on)}$  vs.  $V_{GS}$  vs. Temperature

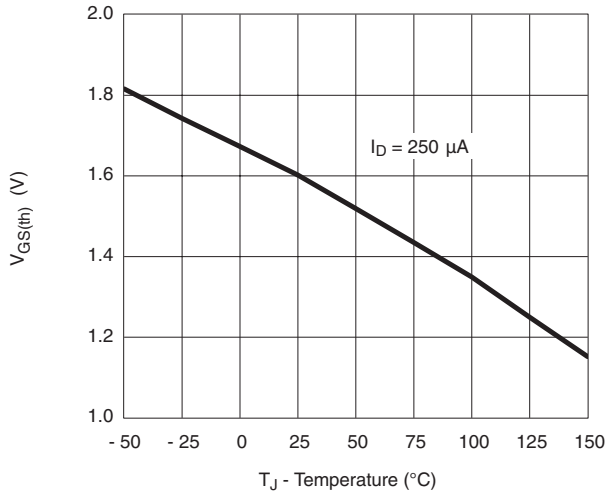

Threshold Voltage

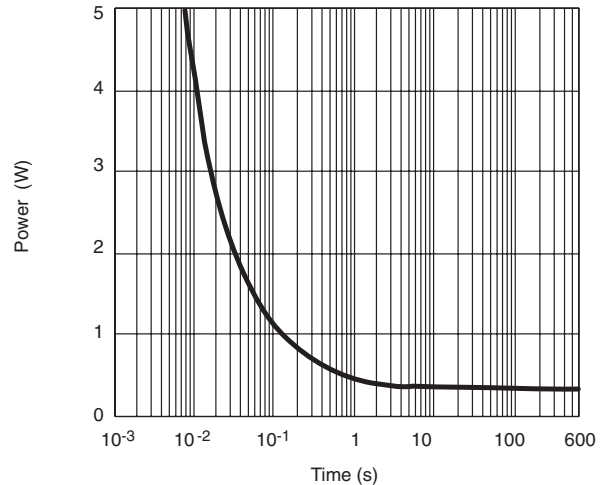

Single Pulse Power

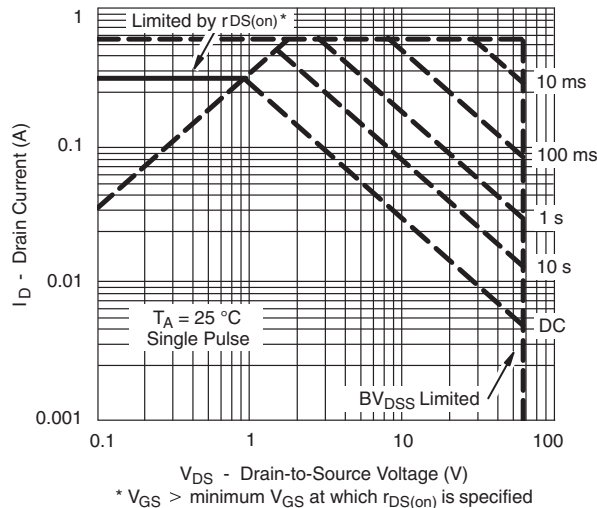

Safe Operating Area



**TYPICAL CHARACTERISTICS** 25 °C, unless otherwise noted

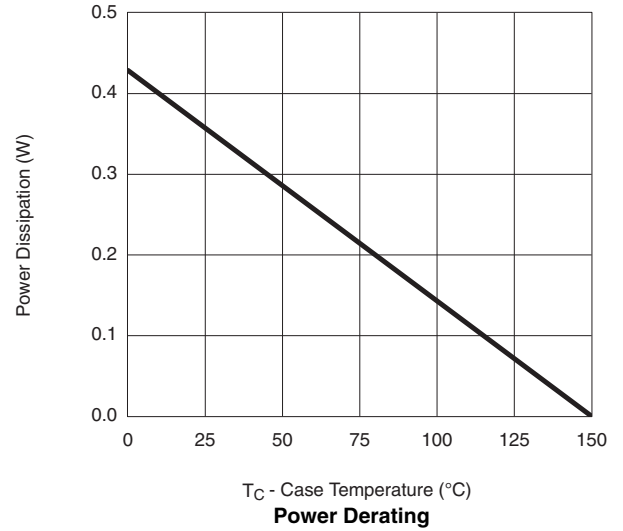
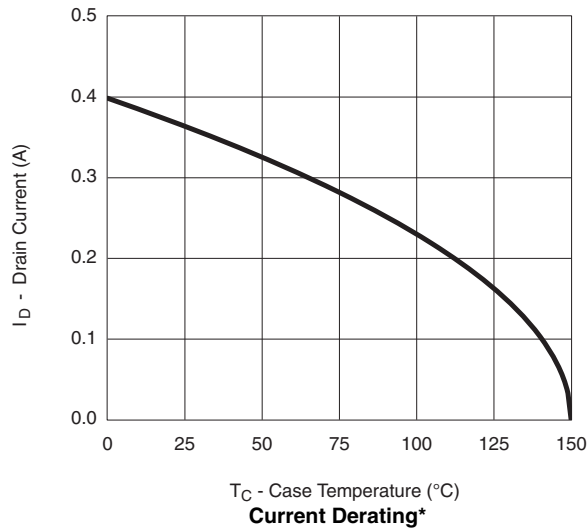

\* The power dissipation  $P_D$  is based on  $T_{J(max)} = 150$  °C, using junction-to-case thermal resistance, and is more useful in settling the upper dissipation limit for cases where additional heatsinking is used. It is used to determine the current rating, when this rating falls below the package limit.

**TYPICAL CHARACTERISTICS** 25 °C, unless otherwise noted

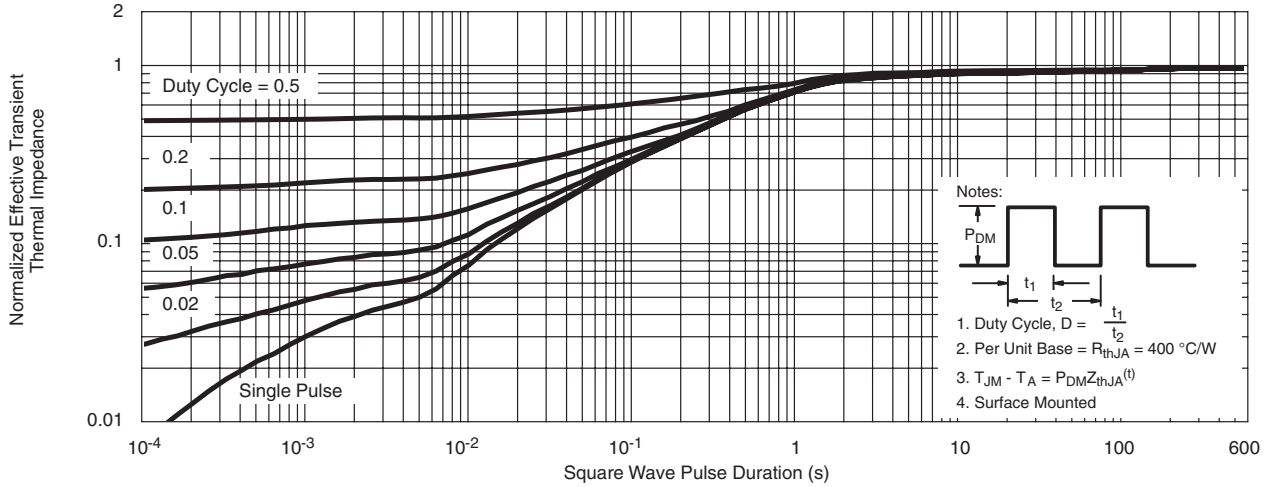

**Normalized Thermal Transient Impedance, Junction-to-Ambient**

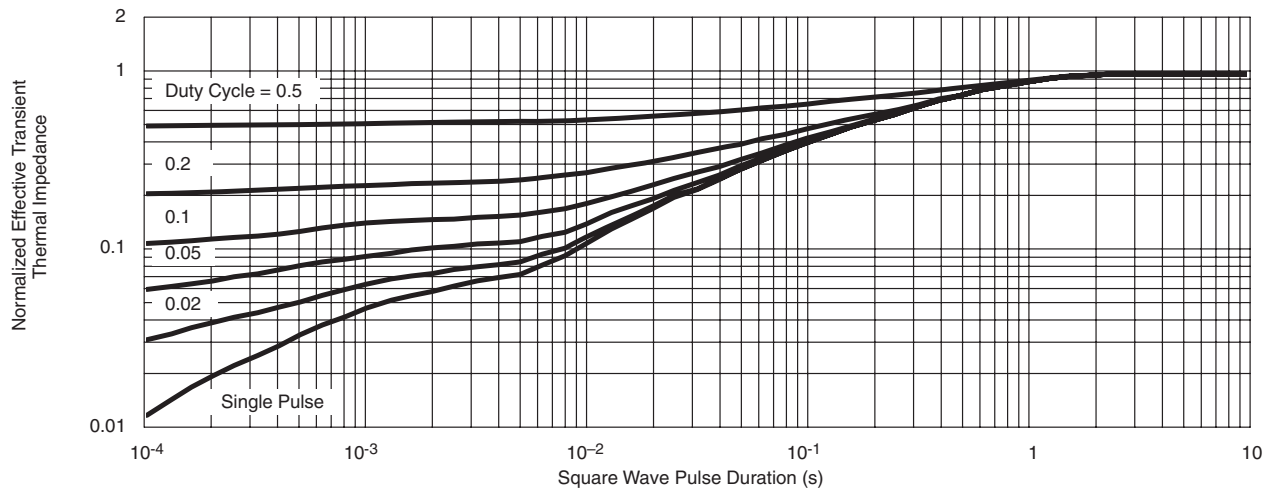

**Normalized Thermal Transient Impedance, Junction-to-Foot**

Vishay Siliconix maintains worldwide manufacturing capability. Products may be manufactured at one of several qualified locations. Reliability data for Silicon Technology and Package Reliability represent a composite of all qualified locations. For related documents such as package/tape drawings, part marking, and reliability data, see <http://www.vishay.com/ppg?73684>.



## Notice

Specifications of the products displayed herein are subject to change without notice. Vishay Intertechnology, Inc., or anyone on its behalf, assumes no responsibility or liability for any errors or inaccuracies.

Information contained herein is intended to provide a product description only. No license, express or implied, by estoppel or otherwise, to any intellectual property rights is granted by this document. Except as provided in Vishay's terms and conditions of sale for such products, Vishay assumes no liability whatsoever, and disclaims any express or implied warranty, relating to sale and/or use of Vishay products including liability or warranties relating to fitness for a particular purpose, merchantability, or infringement of any patent, copyright, or other intellectual property right.

The products shown herein are not designed for use in medical, life-saving, or life-sustaining applications. Customers using or selling these products for use in such applications do so at their own risk and agree to fully indemnify Vishay for any damages resulting from such improper use or sale.

[www.s-manuals.com](http://www.s-manuals.com)