

DESCRIPTION

ST6205 series are highly precise, low noise, positive voltage LDO regulators manufactured using CMOS processes. The series achieves high ripple rejection and low dropout and consists of a standard voltage source, an error correction, current limiter and a phase compensation circuit plus a driver transistor. Output voltage is selectable in 50mV increments within a range of 1.5V~5.0V. The series is also compatible with low ESR ceramic capacitors which give added output stability. This stability can be maintained even during load fluctuations due to the excellent transient response of the series. The current limiter's feedback circuit also operates as a short protect for the output current limiter and the output pin. The CE function enables the output to be turned off, resulting in greatly reduced power consumption. ST6205 family is compatible with low ESR capacitors. The current limiter's feedback circuit also operates as a short protect for the output current limiter.

PIN CONFIGURATION

SOT-23-3L / SOT-323

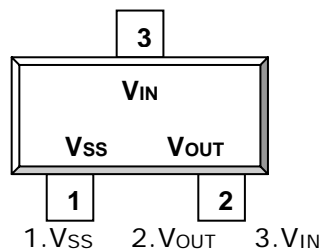

APPLICATIONS

- Battery Power Equipment
- Cellular Phone
- Digital Cameras
- Computer Disk Drivers
- Portable games
- Communication tools

PART MARKING

SOT-23-3L / SOT-323

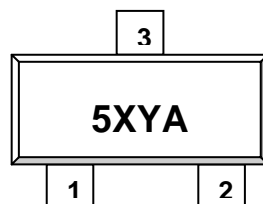

X: Voltage Code
 Y: Year Code
 A: Process Code

FEATURE

- Highly Accurate +/-2%
- Dropout Voltage 300mV @100mA (3.0V type)
- High Ripple Rejection 70dB (10kHz)
- Low Power Consumption 20uA (TYP)
- Maximum Output Current 150mA
- Standby Current less than 0.1uA
- Internal protector current limiter and short protector
- Small packages SOT-23-3L / SOT323, and other required



ORDERING INFORMATION

Part Number	Package	Part Marking
ST6205XS23RG	SOT-323	5XYA
ST6205XS32RG	SOT-23-3L	5XYA

※ Process Code : A ~ Z ; a ~ z

※ ST6205XS23RG X : Voltage Code S : SOT-23-3L ; R : Tape Reel ; G : Pb – Free

※ ST6205XS32RG X : Voltage Code S : SOT-323 ; R : Tape Reel ; G : Pb – Free

PIN DESCRIPTION

SOT-23-3L	SOT-323	Symbol	Description
1	1	V _{SS}	Ground
2	2	V _{OUT}	Voltage Input
3	3	V _{IN}	Voltage Output

VOLTAGE CODE INFORMATION

Voltage Code (X)	Output Voltage (V)
A	1.8
B	2.5
C	2.8
F	3.3

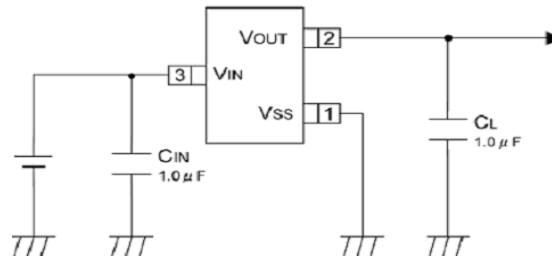
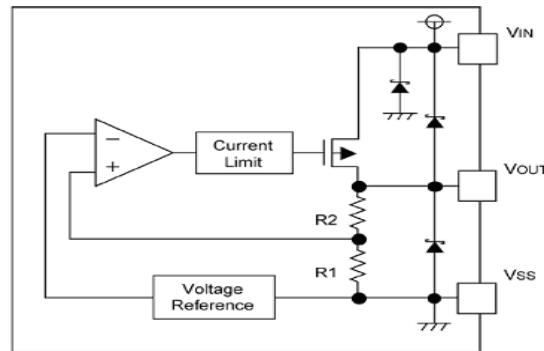
APPLICATION CIRCUIT

BLOCK DIAGRAM

ABSOLUTE MAXIMUM RATINGS ($T_A=25^{\circ}\text{C}$ unless otherwise specified)

Parameter	Symbol	Value	Unit
Input Voltage	V_{IN}	7	V
Output Current	I_{OUT}	500	mA
Output Voltage	V_{OUT}	$V_{SS}-0.3V \sim V_{IN}+0.3V$	mV
Thermal Resistance	θ_{JA}	SOT-23-3L SOT-323	$^{\circ}\text{C}/\text{W}$
Power Dissipation	P_D	SOT-23-3L SOT-323	mW
Operation Junction Temperature Range	T_J	-40 ~ +85	$^{\circ}\text{C}$
Storage Temperature Range	T_{STG}	-55 ~ +125	$^{\circ}\text{C}$

ELECTRICAL CHARACTERISTICS ($T_A = 25^\circ\text{C}$ unless otherwise specified)

Parameter	Symbol	Condition	Min	Typ	Max	Unit
Output Voltage	$V_{OUT(E)}$	$V_{IN} = V_{OUT} + 1.0V, I_{OUT} = 30mA$	x 0.98	$V_{OUT(T)}$	x 1.02	V
Maximum Output Current	I_{OUT}	$V_{IN} \geq V_{OUT} + 1.0V$	300			mA
Load Regulation	ΔV_{OUT}	$V_{OUT(T)} > 1.8V :$ $1mA \leq I_{OUT} \leq 100mA$		25	$V_{OUT(T)}$ X1%	mV
Dropout Voltage	Vdif 1	$I_{OUT} = 30mA$		E2	E2	mV
	Vdif 2	$I_{OUT} = 100mA$		E3	E3	mV
Supply Current	I_{DD}	$V_{IN} = 5V$		1.5	3.0	μA
Line Regulations	$V_{OUT} / (\Delta V_{IN} - V_{OUT})$	$V_{OUT(T)} < 4.5V :$ $V_{OUT(T)} + 1.0V \leq V_{IN} \leq 6V$ $V_{OUT(T)} \geq 4.5V :$ $5.5V \leq V_{IN} \leq 6.0V$ $I_{OUT} = 30mA$		0.05	0.25	%/V
Input Voltage	V_{IN}		1.8		7.0	V
Output Voltage Temperature Characteristics	$\Delta V_{OUT} / (\Delta T_{opr} - V_{OUT})$	$I_{OUT} = 30mA$ $-40^\circ\text{C} \leq T_{opr} \leq 85^\circ\text{C}$		± 100		ppm/ $^\circ\text{C}$
Ripple-Rejection	PSRR	$V_{IN} = V_{OUT} + 1.0V,$ $f = 1KHz, V_{rip} = 0.5V_{rms},$ $I_{OUT} = 60mA$		40		dB
Current Limiter	Ishort	$V_{IN} = V_{OUT} + 1.5V,$ $V_{OUT} = V_{SS}$		E4		mA

(NOTE 1) $V_{OUT(T)}$ = Specified Output Voltage

(NOTE 2) $V_{OUT(E)}$ = Effective Output Voltage (i.e. The output voltage when " $V_{OUT(T)} + 1.0V$ " is provided at the V_{IN} pin while maintaining a certain I_{OUT} value.)

(NOTE 3) Vdif = { V_{IN1} (NOTE5) + V_{OUT1} (NOTE4) }

(NOTE 4) V_{OUT1} = A voltage equal to 98% of the Output Voltage whenever an amply stabilized I_{OUT} { $V_{OUT(T)} + 1.0V$ } is Input.

(NOTE 5) V_{IN1} = The Input Voltage when V_{OUT1} appears as Input Voltage is gradually decreased.

(NOTE 6) Unless otherwise stated, $V_{IN} = V_{OUT(T)} + 1.0V$

VOUT	VOUT (2%)		E1	E2		E3		E4
	Min	Max	IOUT	Vdif1		Vdif2		Ishort
			Min	Typ	Max	Typ	Max	Typ
1.5	1.47	1.53	200	350	500	750	850	155
1.8	1.76	1.86	250	90	150	250	350	130
2.5	2.45	2.55	250	65	120	200	300	115
3.0	2.94	3.06	250	40	100	150	200	80
3.1	3.03	3.16	250	40	100	150	200	80
3.3	3.23	3.36	250	35	100	140	200	80

TEST CIRCUIT

Circuit 1 :

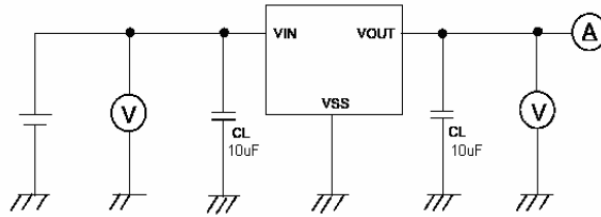

Circuit 2 :

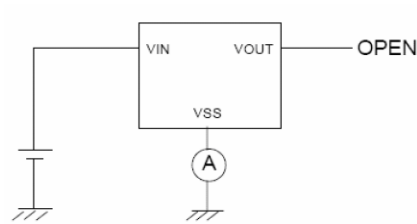

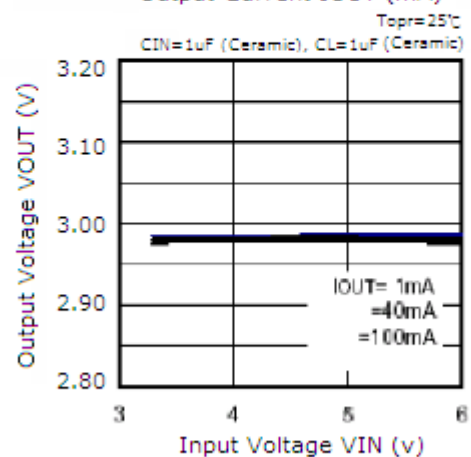
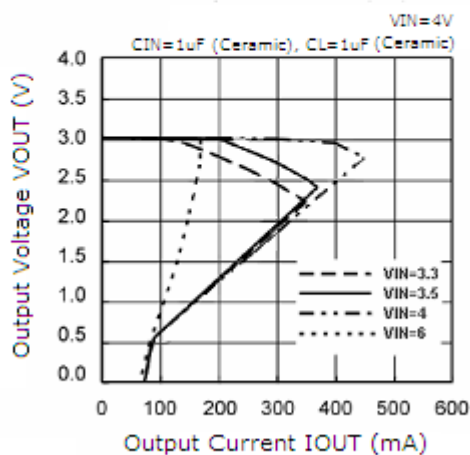
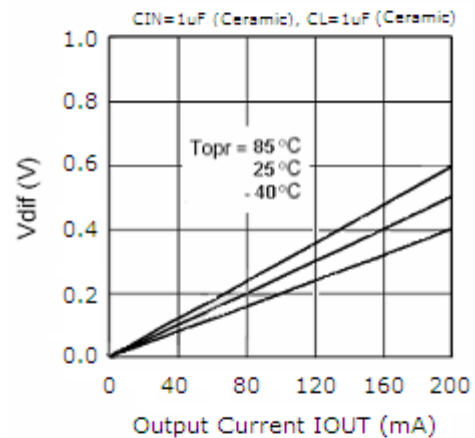
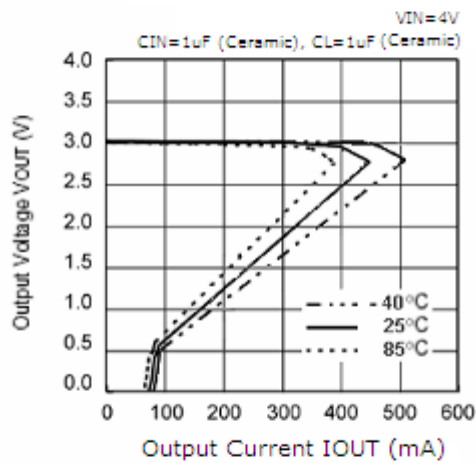
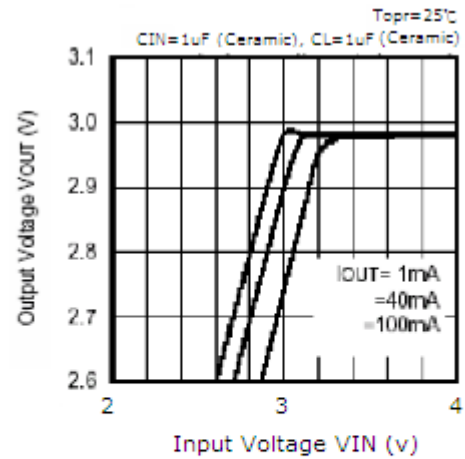
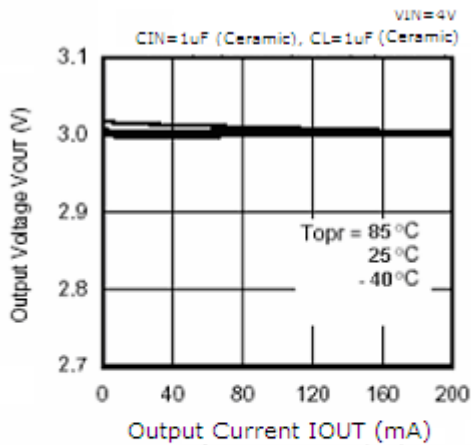
PERFORMANCE CHARACTERISTICS (Voltage Code = 3.0V)

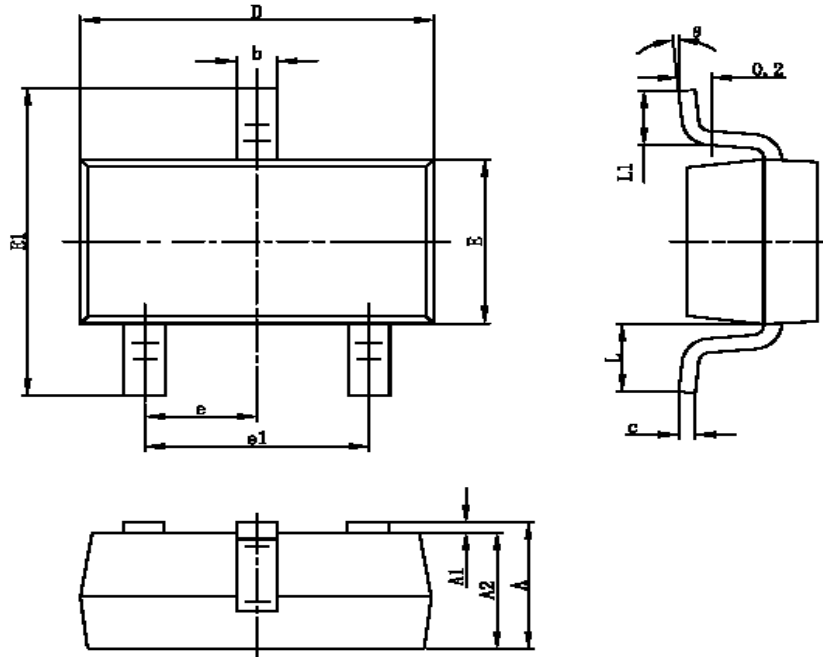
SOT-23-3L PACKAGE OUTLINE

Symbol	Dimensions In Millimeters		Dimensions In Inches	
	Min	Max	Min	Max
A	1.050	1.250	0.041	0.049
A1	0.000	0.100	0.000	0.004
A2	1.050	1.150	0.041	0.045
b	0.300	0.400	0.012	0.016
c	0.100	0.200	0.004	0.008
D	2.820	3.020	0.111	0.119
E	1.500	1.700	0.059	0.067
E1	2.650	2.950	0.104	0.116
e	0.950TYP		0.037TYP	
e1	1.800	2.000	0.071	0.079
L	0.700REF		0.028REF	
L1	0.300	0.600	0.012	0.024
θ	0°	8°	0°	8°

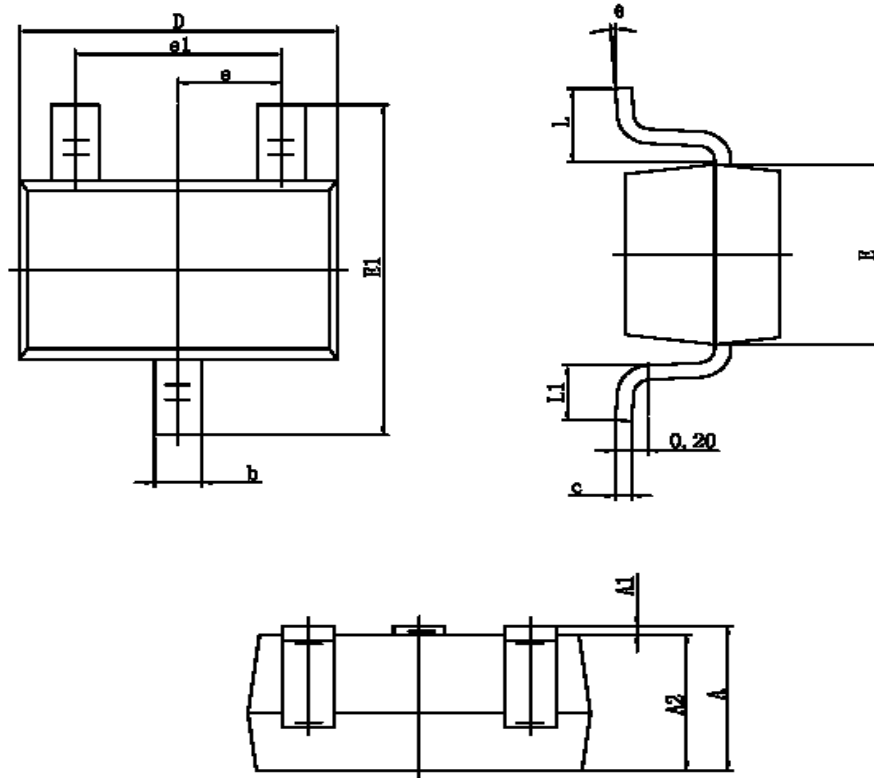
SOT-323 PACKAGE OUTLINE

Symbol	Dimensions In Millimeters		Dimensions In Inches	
	Min	Max	Min	Max
A	0.900	1.100	0.035	0.043
A1	0.000	0.100	0.000	0.004
A2	0.900	1.000	0.035	0.039
b	0.200	0.400	0.008	0.016
c	0.080	0.150	0.003	0.006
D	2.000	2.200	0.079	0.087
E	1.150	1.350	0.045	0.053
E1	2.150	2.450	0.085	0.096
e	0.650TYP		0.026TYP	
e1	1.200	1.400	0.047	0.055
L	0.525REF		0.021REF	
L1	0.260	0.460	0.010	0.018
• •	0°	8°	0°	8°

www.s-manuals.com