

DESCRIPTION

ST6206 family is a positive voltage linear regulators, low power consumption, high voltage manufactured with CMOS technology. It provides large currents with a low dropout voltage. ST6206 consists of current limiter circuit, driver transistor, precision reference voltage and error correction circuit. ST6206 family is compatible with low ESR capacitors. The current limiter's feedback circuit also operates as a short protect for the output current limiter. SOT-23-3L / SOT-323 packages are available for portable electronic equipment.

PIN CONFIGURATION

SOT-23-3L / SOT-323

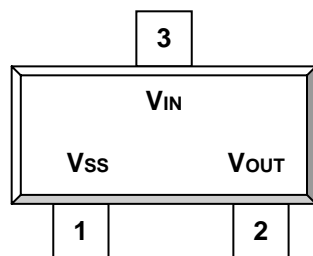

1.Vss 2.Vout 3.Vin

APPLICATIONS

- Battery Power Equipment
- Cellular Phone
- Digital Cameras
- Computer Disk Drivers
- Portable games
- Communication tools

PART MARKING

SOT-23-3L / SOT-323

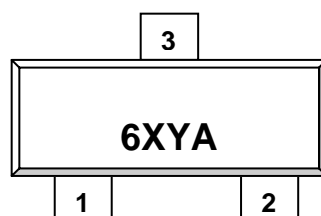

X: Voltage Code
Y: Year Code
A: Process Code

FEATURE

- Maximum Output Current 250mA (5.0V type)
- Dropout Voltage 160mV @100mA (5.0V type)
- Low Supply Current at 3uA max.
- Output Voltage: 1.5V; 1.8V; 2.5V; 3.0V; 3.1V; 3.3V
- Highly Accurate +/-2%
- Ultra Small Pb-Free Packages
- Low ESR capacitor ceramic compatible

ORDERING INFORMATION

Part Number	Package	Part Marking
ST6206XS23RG	SOT-23-3L	6XYA
ST6206XS32RG	SOT-323	6XYA

※ Process Code : A ~ Z ; a ~ z

※ ST6206XS23RG X : Voltage Code S : SOT-23-3L ; R : Tape Reel ; G : Pb – Free

※ ST6206XS32RG X : Voltage Code S : SOT-323 ; R : Tape Reel ; G : Pb – Free



PIN DESCRIPTION

SOT-23-3L	SOT-323	Symbol	Description
1	1	V _{SS}	Ground
2	2	V _{OUT}	Voltage Input
3	3	V _{IN}	Voltage Output

VOLTAGE CODE INFORMATION

Voltage Code (X)	Output Voltage (V)
A	1.5
B	1.8
C	2.5
D	3.0
E	3.1
F	3.3

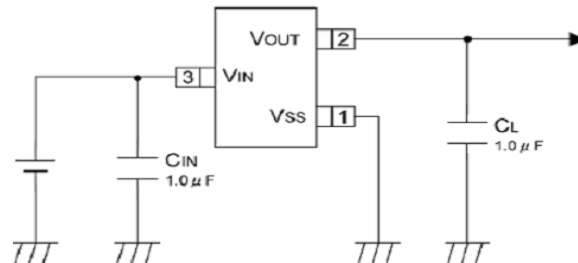
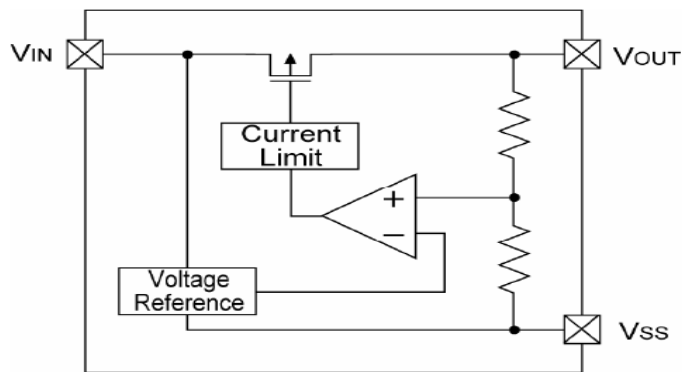
APPLICATION CIRCUIT

BLOCK DIAGRAM

ABSOLUTE MAXIMUM RATINGS ($T_A=25^{\circ}\text{C}$ Unless otherwise specified)

Parameter	Symbol	Value	Unit	
Input Voltage	V_{IN}	7	V	
Output Current	I_{OUT}	500	mA	
Output Voltage	V_{OUT}	$V_{SS}-0.3\text{V} \sim V_{IN}+0.3\text{V}$	mA	
Thermal Resistance	θ_{JA}	SOT-23-3L SOT-323	105 105	$^{\circ}\text{C}/\text{W}$
Power Dissipation	P_D	SOT-23-3L SOT-323	330 330	mW
Operation Junction Temperature Range	T_J	-40 ~ +85	$^{\circ}\text{C}$	
Storage Temperature Range	T_{STG}	-55 ~ +125	$^{\circ}\text{C}$	

ELECTRICAL CHARACTERISTICS ($T_A = 25^\circ\text{C}$ Unless otherwise specified)

Parameter	Symbol	Condition	Min	Typ	Max	Unit
Output Voltage	$V_{OUT(E)}$	$I_{OUT} = 30\text{mA}$	x 0.98	$V_{OUT(T)}$	x 1.02	V
Maximum Output Current	I_{OUT}	$V_{IN} = 5\text{V}$	E1			mA
Load Regulation	ΔV_{OUT}	$V_{OUT(T)} > 1.8\text{V} :$ $1\text{mA} \leq I_{OUT} \leq 100\text{mA}$		25	$V_{OUT(T)}$ X1%	mV
Dropout Voltage	Vdif 1	$I_{OUT} = 30\text{mA}$		E2	E2	mV
	Vdif 2	$I_{OUT} = 100\text{mA}$		E3	E3	mV
Supply Current	I_{DD}	$V_{IN} = 5\text{V}$		1.5	3.0	uA
Line Regulations	$V_{OUT} / (\Delta V_{IN} - V_{OUT})$	$V_{OUT(T)} < 4.5\text{V} :$ $V_{OUT(T)} + 1.0\text{V} \leq V_{IN} \leq 6\text{V}$ $V_{OUT(T)} \geq 4.5\text{V} :$ $5.5\text{V} \leq V_{IN} \leq 6.0\text{V}$ $I_{OUT} = 30\text{mA}$		0.05	0.25	%/V
Input Voltage	V_{IN}		1.8		7.0	V
Output Voltage Temperature Characteristics	$\Delta V_{OUT} / (\Delta T_{opr} - V_{OUT})$	$I_{OUT} = 30\text{mA}$ $-40^\circ\text{C} \leq T_{opr} \leq 85^\circ\text{C}$		± 100		ppm/ $^\circ\text{C}$
Ripple-Rejection	PSRR	$V_{IN} = V_{OUT} + 1.0\text{V},$ $f = 1\text{KHz}, V_{rip} = 0.5\text{Vrms},$ $I_{OUT} = 60\text{mA}$		40		dB
Current Limiter	I_{short}	$V_{IN} = V_{OUT} + 1.5\text{V},$ $V_{OUT} = V_{SS}$		E4		mA

(NOTE 1) $V_{OUT(T)}$ = Specified Output Voltage

(NOTE 2) $V_{OUT(E)}$ = Effective Output Voltage (i.e. The output voltage when " $V_{OUT(T)} + 1.0\text{V}$ " is provided at the V_{IN} pin while maintaining a certain I_{OUT} value.)

(NOTE 3) $V_{dif} = \{V_{IN1} (\text{NOTE5}) + V_{OUT1} (\text{NOTE4})\}$

(NOTE 4) V_{OUT1} = A voltage equal to 98% of the Output Voltage whenever an amply stabilized I_{OUT} ($V_{OUT(T)} + 1.0\text{V}$) is Input.

(NOTE 5) V_{IN1} = The Input Voltage when V_{OUT1} appears as Input Voltage is gradually decreased.

(NOTE 6) Unless otherwise stated, $V_{IN} = V_{OUT(T)} + 1.0\text{V}$

V_{OUT}	$V_{OUT} (2\%)$		E1	E2		E3		E4
			I_{OUT}	Vdif1		Vdif2		I_{short}
	Min	Max	Min	Typ	Max	Typ	Max	Typ
1.5	1.47	1.53	200	350	500	750	850	155
1.8	1.76	1.86	250	90	150	250	350	130
2.5	2.45	2.55	250	65	120	200	300	115
3.0	2.94	3.06	250	40	100	150	200	80
3.1	3.03	3.16	250	40	100	150	200	80
3.3	3.23	3.36	250	35	100	140	200	80

TEST CIRCUIT

Circuit 1 :

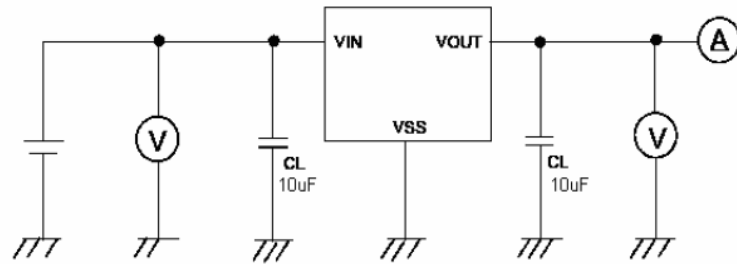

Circuit 2 :

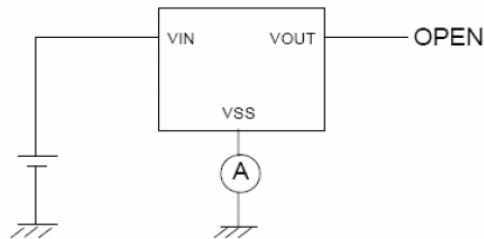

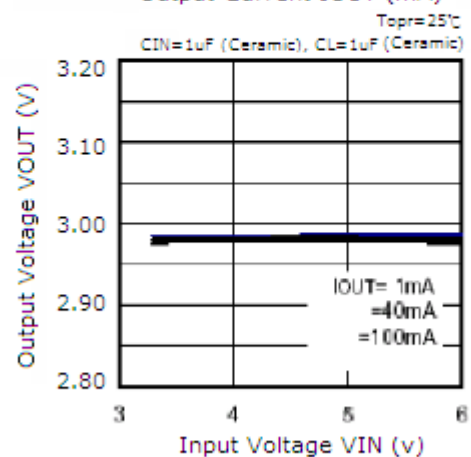
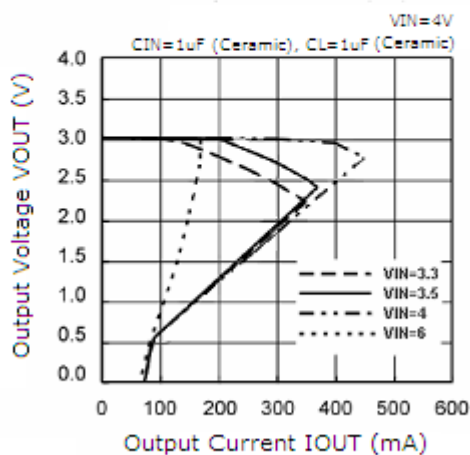
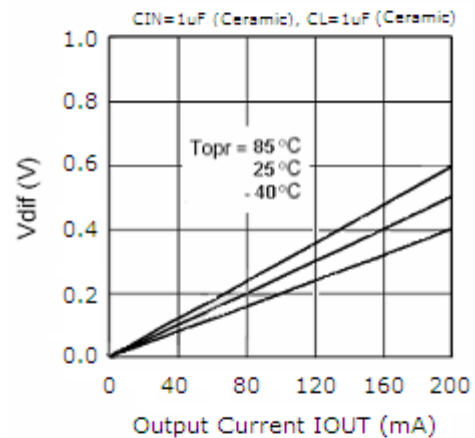
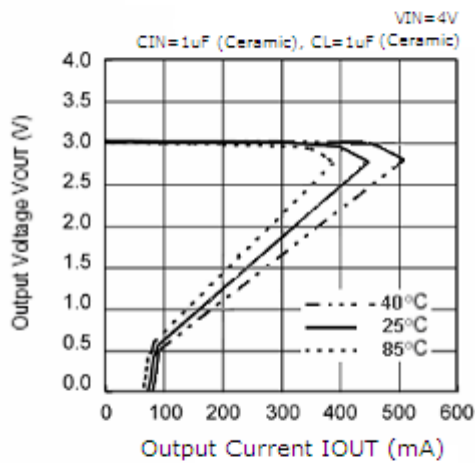
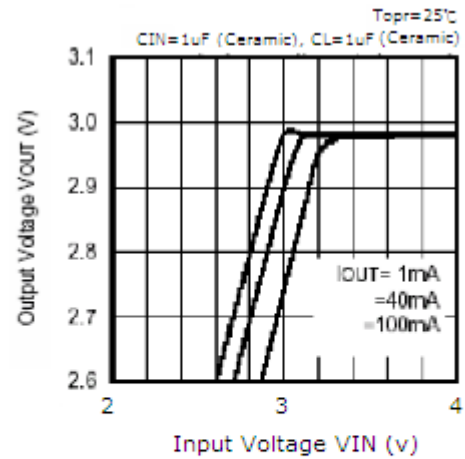
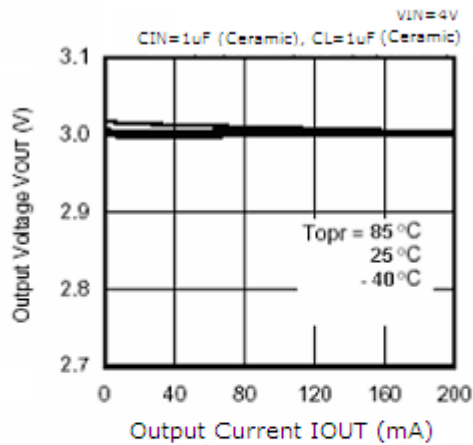
PERFORMANCE CHARACTERISTICS (Voltage Code = 3.0V)

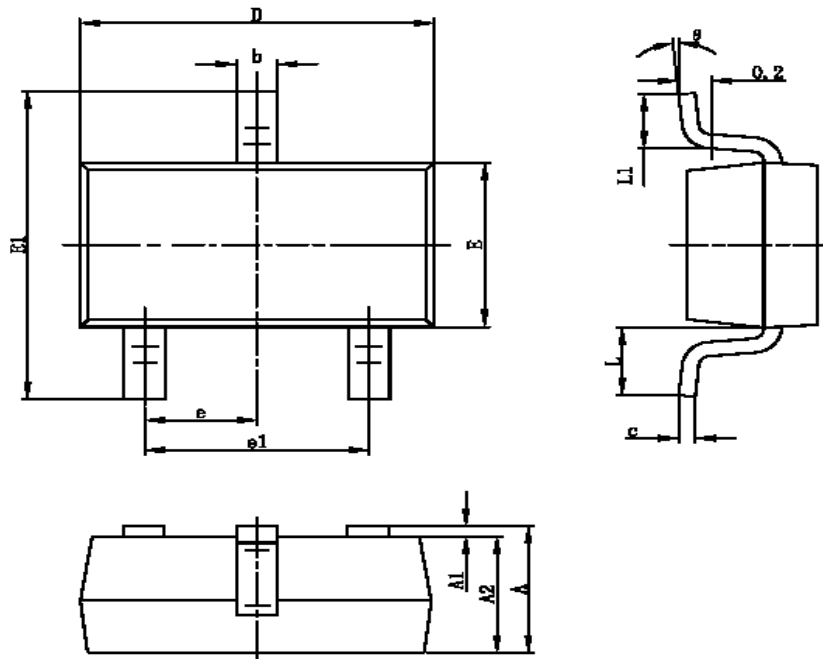
SOT-23-3L PACKAGE OUTLINE

Symbol	Dimensions In Millimeters		Dimensions In Inches	
	Min	Max	Min	Max
A	1.050	1.250	0.041	0.049
A1	0.000	0.100	0.000	0.004
A2	1.050	1.150	0.041	0.045
b	0.300	0.400	0.012	0.016
c	0.100	0.200	0.004	0.008
D	2.820	3.020	0.111	0.119
E	1.500	1.700	0.059	0.067
E1	2.650	2.950	0.104	0.116
e	0.950TYP		0.037TYP	
e1	1.800	2.000	0.071	0.079
L	0.700REF		0.028REF	
L1	0.300	0.600	0.012	0.024
θ	0°	8°	0°	8°

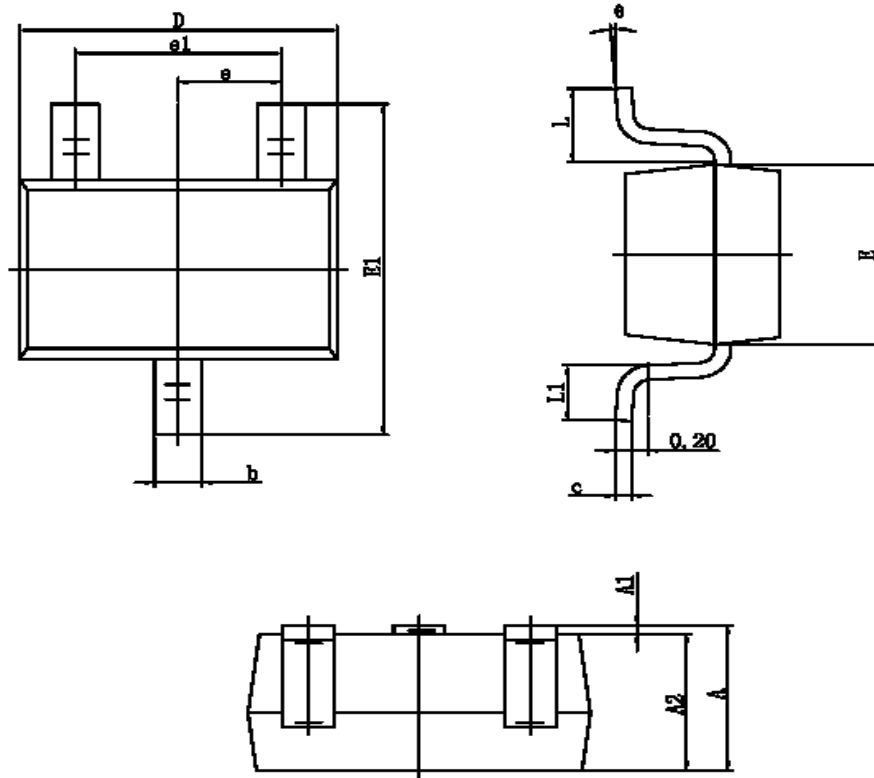
SOT-323 PACKAGE OUTLINE

Symbol	Dimensions In Millimeters		Dimensions In Inches	
	Min	Max	Min	Max
A	0.900	1.100	0.035	0.043
A1	0.000	0.100	0.000	0.004
A2	0.900	1.000	0.035	0.039
b	0.200	0.400	0.008	0.016
c	0.080	0.150	0.003	0.006
D	2.000	2.200	0.079	0.087
E	1.150	1.350	0.045	0.053
E1	2.150	2.450	0.085	0.096
e	0.650TYP		0.026TYP	
e1	1.200	1.400	0.047	0.055
L	0.525REF		0.021REF	
L1	0.260	0.460	0.010	0.018
••	0°	8°	0°	8°

www.s-manuals.com