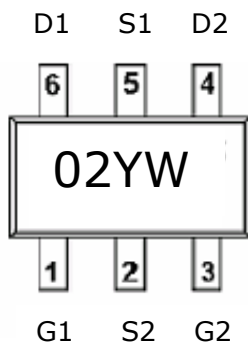

DESCRIPTION

The STC6602 is the dual N&P-Channel enhancement mode power field effect transistor which is produced using high cell density, DMOS trench technology. This high density process is especially tailored to minimize on-state resistance. These devices are particularly suited for low voltage application, such as notebook computer power management and other battery powered circuits, where high-side switching is required.

PIN CONFIGURATION
TSOP-6

Y: Year
A: Week Code

FEATURE

- ◆ N-Channel
30V/2.8A, $R_{DS(ON)} = 60m\Omega @ V_{GS} = 10V$
30V/2.3A, $R_{DS(ON)} = 80m\Omega @ V_{GS} = 4.5V$
- ◆ P-Channel
-30V/-2.8A, $R_{DS(ON)} = 105m\Omega @ V_{GS} = -10V$
-30V/-2.5A, $R_{DS(ON)} = 135m\Omega @ V_{GS} = -4.5V$
- ◆ Super high density cell design for extremely low $R_{DS(ON)}$
- ◆ Exceptional on-resistance and maximum DC current capability
- ◆ TSOP-6P package design

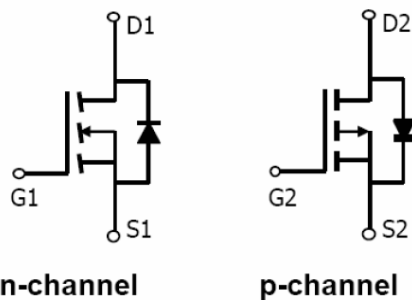
ORDERING INFORMATION

Part Number	Package	Part Marking
STC6602ST6RG	TSOP-6	02YW

※ Week Code Code : A ~ Z ; a ~ z

※ STC6602ST6RG ST6 : TSOP-6; R: Tape Reel ; G: Pb - Free



STC6602 

Dual N&P Channel Enhancement Mode
MOSFET
2.8A/-2.8A

ABSOLUTE MAXIMUM RATINGS (Ta = 25°C Unless otherwise noted)

Parameter		Symbol	Typical		Unit
			N	P	
Drain-Source Voltage		V _{DSS}	30	-30	V
Gate-Source Voltage		V _{GSS}	±20	±20	V
Continuous Drain Current (T _J =150°C)	T _A =25°C	I _D	2.8	-2.8	A
	T _A =70°C		2.3	-2.1	
Pulsed Drain Current		I _{DM}	10	-8	A
Continuous Source Current (Diode Conduction)		I _S	1.25	-1.4	A
Power Dissipation	T _A =25°C	P _D	1.15		W
	T _A =70°C		0.75		
Operation Junction Temperature		T _J	-55/150		°C
Storage Temperature Range		T _{STG}	-55/150		°C
Thermal Resistance-Junction to Ambient	T ≅ 10sec	R _{θJA}	50	52	°C/W
	Steady State		90	90	



STC6602 

Dual N&P Channel Enhancement Mode
MOSFET
2.8A/-2.8A

ELECTRICAL CHARACTERISTICS (Ta = 25°C Unless otherwise noted)

Parameter	Symbol	Condition	Min	Typ	Max	Unit	
Static							
Drain-Source Breakdown Voltage	$V_{(BR)DSS}$	$V_{GS}=0V, I_D=250\mu A$ $V_{GS}=0V, I_D=-250\mu A$	N p	30 -30		V	
Gate Threshold Voltage	$V_{GS(th)}$	$V_{DS}=V_{GS}, I_D=250\mu A$ $V_{DS}=V_{GS}, I_D=-250\mu A$	N P	1 1	3 -3	V	
Gate Leakage Current	I_{GSS}	$V_{DS}=0V, V_{GS}=\pm 20V$	N p		± 100 ± 100	nA	
Zero Gate Voltage Drain Current	I_{DSS}	$V_{DS}=30V, V_{GS}=0V$	N		1	uA	
		$V_{DS}=-30V, V_{GS}=0V$	P		-1		
		$V_{DS}=30V, V_{GS}=0V$ $T_J=55^\circ C$	N		10		
		$V_{DS}=-30V, V_{GS}=0V$ $T_J=55^\circ C$	P		-10		
On-State Drain Current	$I_{D(on)}$	$V_{DS}\leq 5V, V_{GS}=10V$ $V_{DS}\leq -5V, V_{GS}=-10V$		6 -6		A	
Drain-source On-Resistance	$R_{DS(on)}$	$V_{GS}=10V, I_D=2.8A$ $V_{GS}=-10V, I_D=-2.8A$			0.043 0.088	0.060 0.105	Ω
		$V_{GS}=4.5V, I_D=2.3A$ $V_{GS}=-4.5V, I_D=-2.5A$			0.056 0.118	0.080 0.135	
Forward Transconductance	g_{fs}	$V_{DS}=10V, I_D=2.8A$ $V_{DS}=-10V, I_D=-2.8A$			4.6 -4	S	
Diode Forward Voltage	V_{SD}	$I_S=1.25A, V_{GS}=0V$ $I_S=-1.2A, V_{GS}=0V$			0.8 -0.8	1.2 -1.2	V
Dynamic							
Total Gate Charge	Q_g	N-Channel $V_{DS}=15V, V_{GS}=4.5V,$ $V_{DS}=2.0A$ P-channel $V_{DS}=-15V, V_{GS}=-4.5V,$ $V_{DS}=-2.0A$	N P		4.5 5.8	10 10	nC
Gate-Source Charge	Q_{gs}		N P		0.8 0.8		
Gate-Drain Charge	Q_{gd}		N P		1.0 1.5		
Turn-On Time	$T_{d(on)}$	N-Channel $V_{DD}=15V, R_L=10\Omega,$ $V_{GEN}=10V, R_G=3\Omega$ P-Channel $V_{DD}=-15V, R_L=15\Omega,$ $V_{GEN}=-10V, R_G=3\Omega$	N P		8 9	20 20	nS
	t_r		N P		12 9	30 20	
Turn-Off Time	$T_{d(off)}$		N P		17 18	35 35	
	t_f		N P		8 6	20 20	

TYPICAL CHARACTERISTICS (N-Channel)

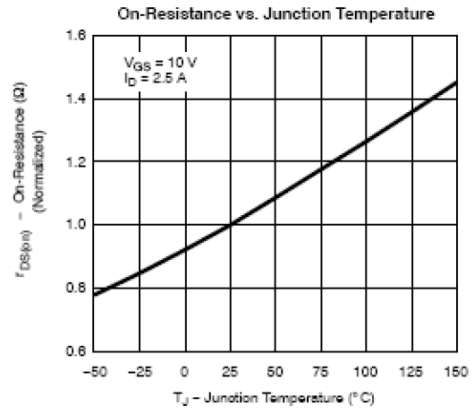
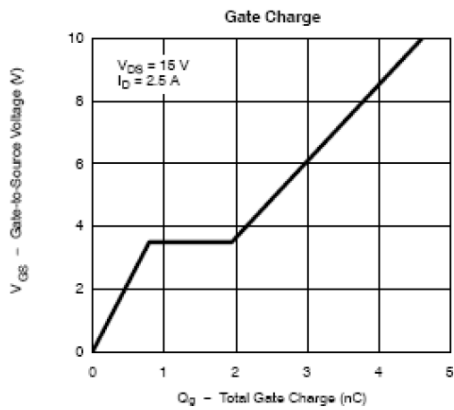
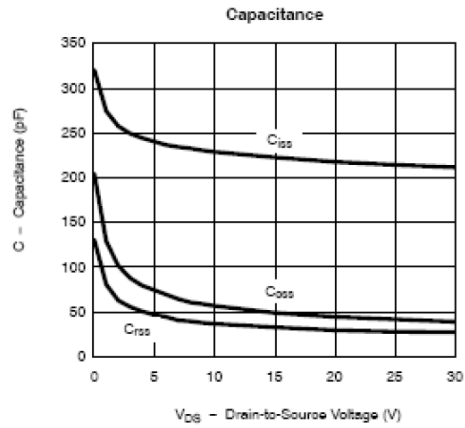
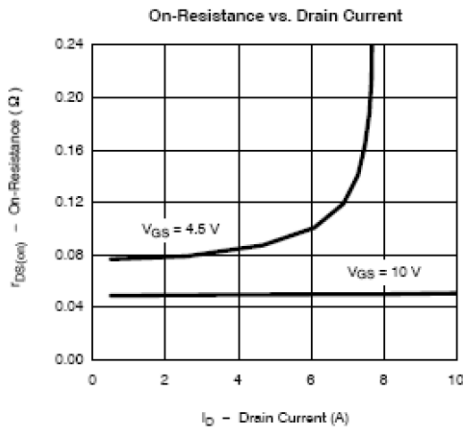
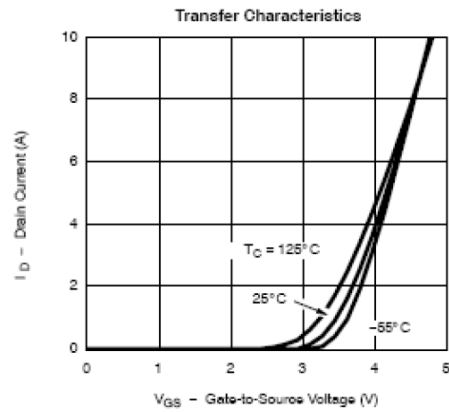
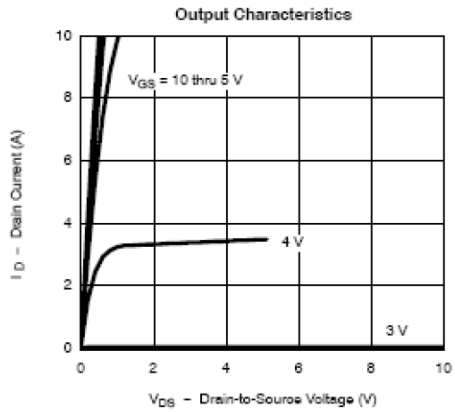

TYPICAL CHARACTERISTICS (N-Channel)

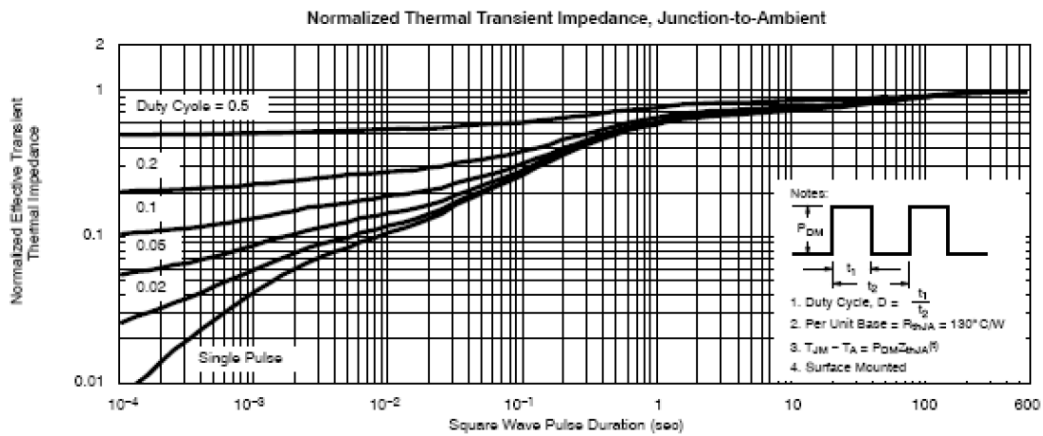
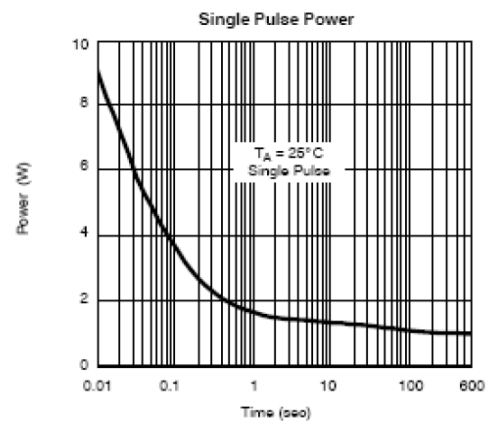
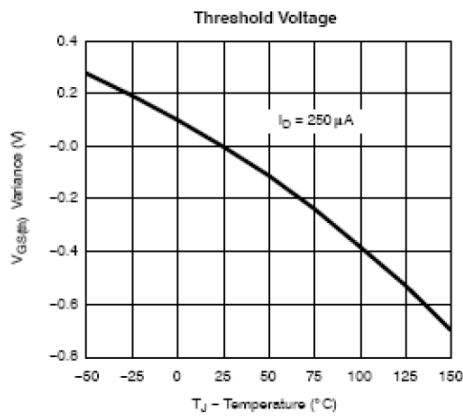
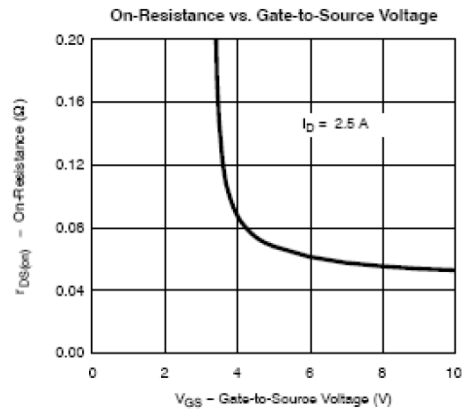
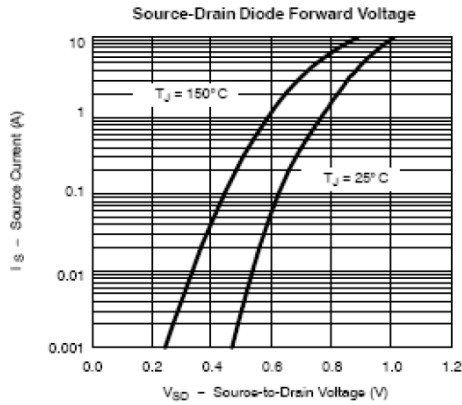

TYPICAL CHARACTERISTICS (P-Channel)

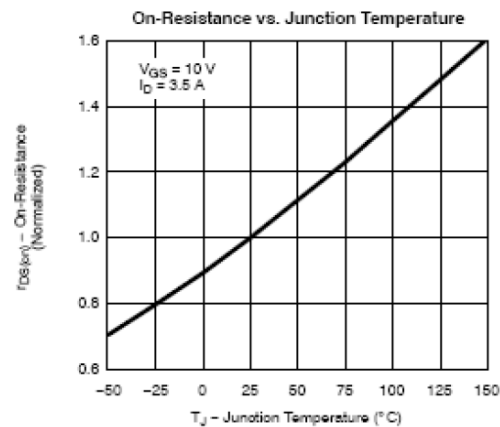
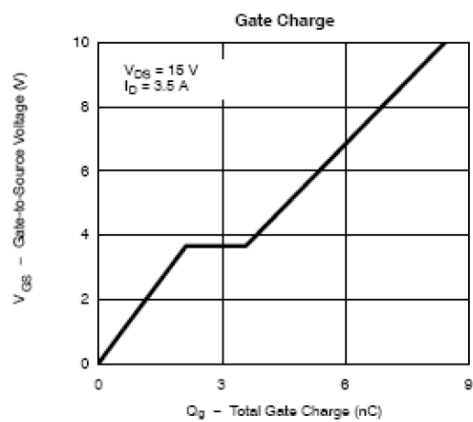
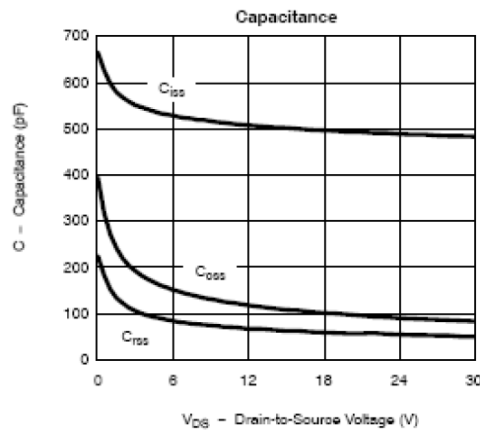
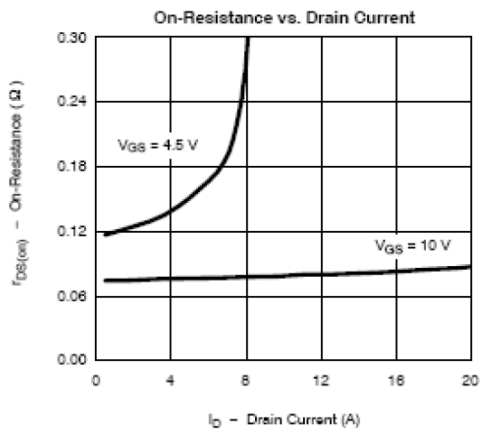
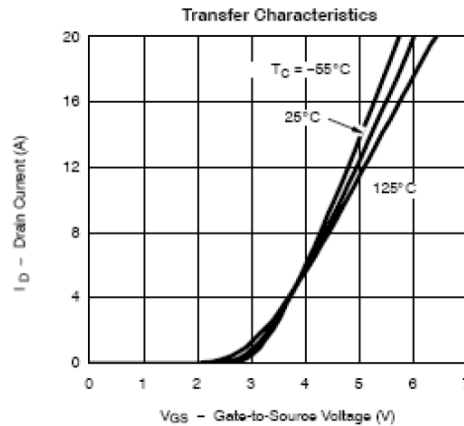
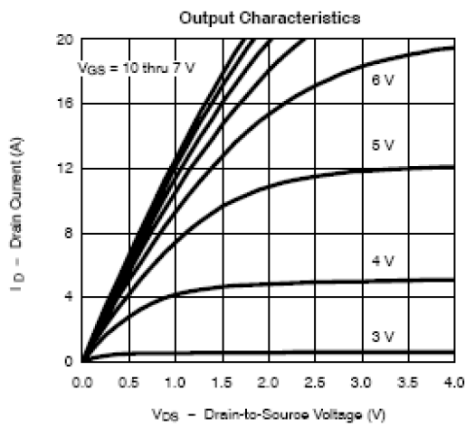

TYPICAL CHARACTERISTICS (P-Channel)

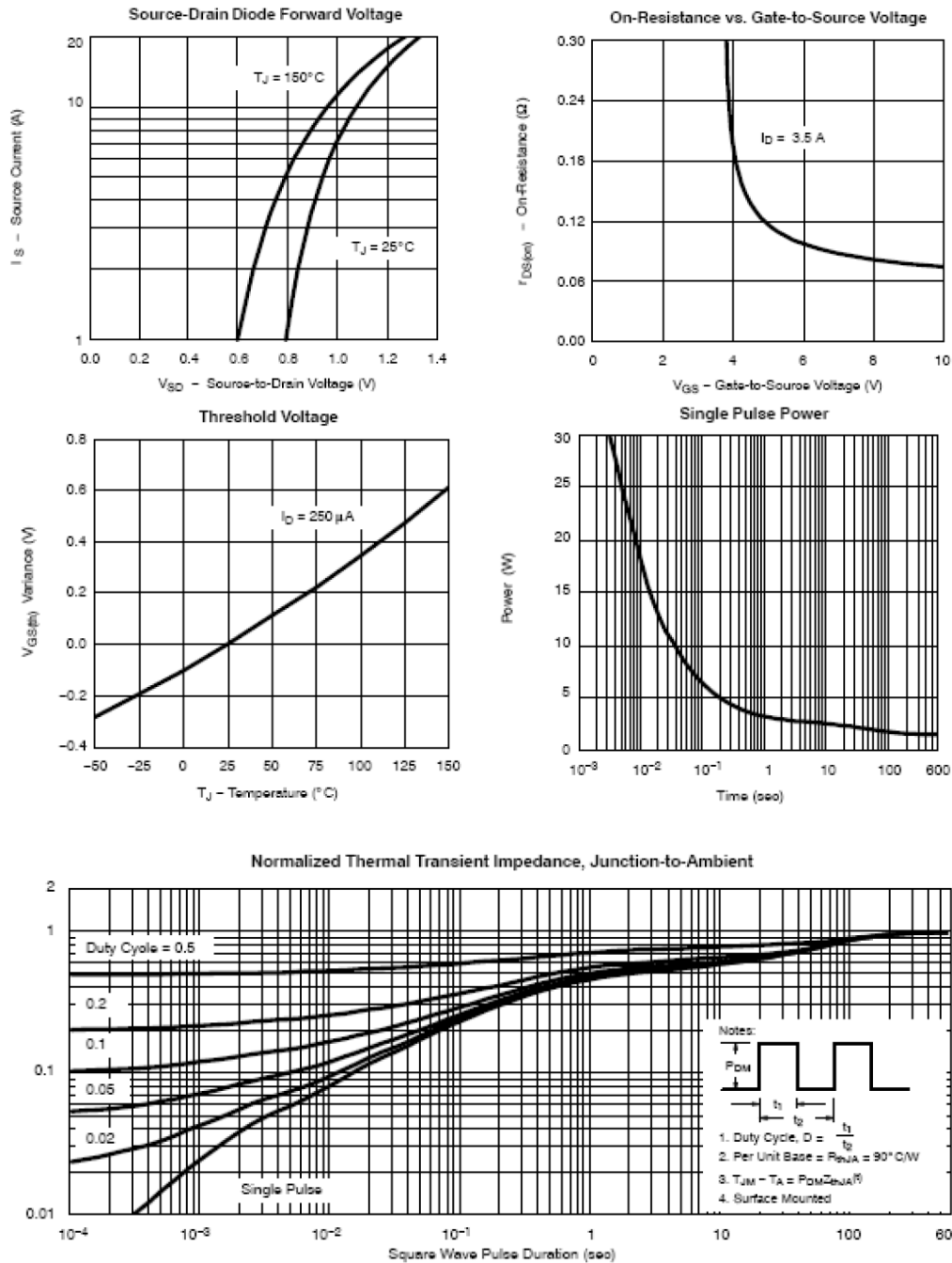

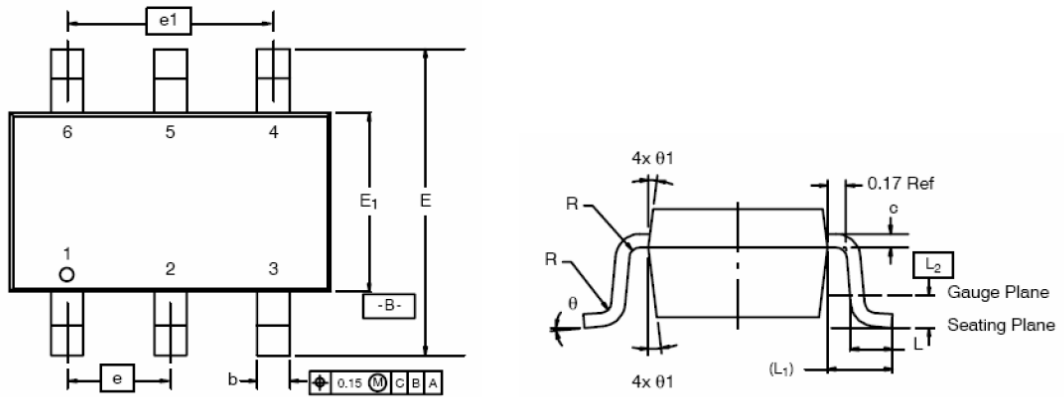
TSOP-6 PACKAGE OUTLINE

Dim	MILLIMETERS			INCHES		
	Min	Nom	Max	Min	Nom	Max
A	0.91	-	1.10	0.036	-	0.043
A ₁	0.01	-	0.10	0.0004	-	0.004
A ₂	0.90	-	1.00	0.035	0.038	0.039
b	0.30	0.32	0.45	0.012	0.013	0.018
c	0.10	0.15	0.20	0.004	0.006	0.008
D	2.95	3.05	3.10	0.116	0.120	0.122
E	2.70	2.85	2.98	0.106	0.112	0.117
E ₁	1.55	1.65	1.70	0.061	0.065	0.067
e	1.00 BSC			0.0394 BSC		
e ₁	1.90	2.00	2.10	0.075	0.080	0.085
L	0.35	-	0.50	0.014	-	0.020
L ₁	0.60 Ref			0.024 Ref		
L ₂	0.25 BSC			0.010 BSC		
R	0.10	-	-	0.004	-	-
θ	0°	4°	8°	0°	4°	8°
θ ₁	7° Nom			7° Nom		

www.s-manuals.com