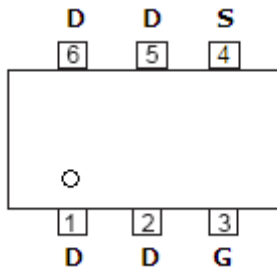
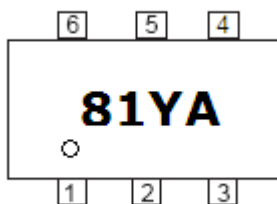

DESCRIPTION

The STP3481 is the P-Channel logic enhancement mode power field effect transistors are produced using high cell density , DMOS trench technology. This high density process is especially tailored to minimize on-state resistance. These devices are particularly suited for low voltage application such as cellular phone and notebook computer power management and other battery powered circuits, and low in-line power loss are needed in a very small outline surface mount package.

**PIN CONFIGURATION
TSOP-6P**

1.2.5.6.Drain 3.Gate 4.Source

**PART MARKING
TSOP-6P**

Y: Year Code A: Process Code

FEATURE

- -30V/-5.2A, $R_{DS(ON)} = 55\text{m-ohm}$
@VGS = -10V
- -30V/-4.2A, $R_{DS(ON)} = 75\text{m-ohm}$
@VGS = -4.5V
- Super high density cell design for extremely low $R_{DS(ON)}$
- Exceptional on-resistance and maximum DC current capability
- TSOP-6P package design

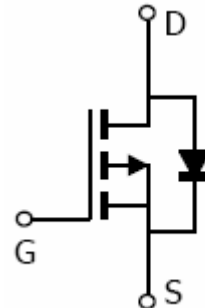
ORDERING INFORMATION

Part Number	Package	Part Marking
STP3481S6RG	TSOP-6P	81YA

※ Process Code : A ~ Z ; a ~ z



STP3481 

P Channel Enhancement Mode MOSFET

-5.2A

※ STP3481S6RG S6 : TSOP-6P ; R : Tape Reel ; G : Pb – Free

ABSOLUTE MAXIMUM RATINGS (Ta = 25°C Unless otherwise noted)

Parameter	Symbol	Typical	Unit
Drain-Source Voltage	V _{DSS}	-30	V
Gate-Source Voltage	V _{GSS}	±20	V
Continuous Drain Current (T _J =150°C)	I _D	T _A =25°C -5.2	A
		T _A =70°C -4.2	
Pulsed Drain Current	I _{DM}	-20	A
Continuous Source Current (Diode Conduction)	I _S	-1.7	A
Power Dissipation	P _D	T _A =25°C 2.0	W
		T _A =70°C 1.3	
Operation Junction Temperature	T _J	150	°C
Storage Temperature Range	T _{STG}	-55/150	°C
Thermal Resistance-Junction to Ambient	R _{θJA}	90	°C/W

ELECTRICAL CHARACTERISTICS (Ta = 25°C Unless otherwise noted)

Parameter	Symbol	Condition	Min	Typ	Max	Unit
Static						
Drain-Source Breakdown Voltage	$V_{(BR)DSS}$	$V_{GS}=0V, I_D=-250\mu A$	-30			V
Gate Threshold Voltage	$V_{GS(th)}$	$V_{DS}=V_{GS}, I_D=-250\mu A$	-1.0		-3.0	V
Gate Leakage Current	I_{GSS}	$V_{DS}=0V, V_{GS}=\pm 20V$			± 100	Na
Zero Gate Voltage Drain Current	I_{DSS}	$V_{DS}=-24V, V_{GS}=0V$			-1	UA
		$V_{DS}=-24V, V_{GS}=0V$ $T_J=55^\circ C$			-10	
On-State Drain Current	$I_{D(on)}$	$V_{DS} \leq -5V, V_{GS}=-10V$	-10			A
Drain-source On-Resistance	$R_{DS(on)}$	$V_{GS}=-10.0V, I_D=-5.2A$ $V_{GS}=-4.5V, I_D=-4.2A$		0.041 0.058	0.055 0.075	Ω
Forward Transconductance	g_{fs}	$V_{DS}=-5.0V, I_D=-4.0A$		10		S
Diode Forward Voltage	V_{SD}	$I_S=-1.0A, V_{GS}=0V$		-0.8	-1.2	V
Dynamic						
Total Gate Charge	Q_g	$V_{DS}=-15V$ $V_{GS}=-10V$ $I_D=-4.0A$		14	21	nC
Gate-Source Charge	Q_{gs}			1.9		
Gate-Drain Charge	Q_{gd}			3.7		
Input Capacitance	C_{iss}	$V_{DS}=-15V$ $V_{GS}=0V$ $F=1MHz$		540		pF
Output Capacitance	C_{oss}			131		
Reverse Transfer Capacitance	C_{rss}			105		
Turn-On Time	$t_{d(on)}$ t_r	$V_{DD}=-15V$ $R_L=15\Omega$ $I_D=-1.0A$ $V_{GEN}=-10V$ $R_G=6\Omega$		10	16	nS
Turn-Off Time	$t_{d(off)}$ t_f			15	25	
				32	50	
				21	32	

TYPICAL CHARACTERISTICS (25°C Unless noted)

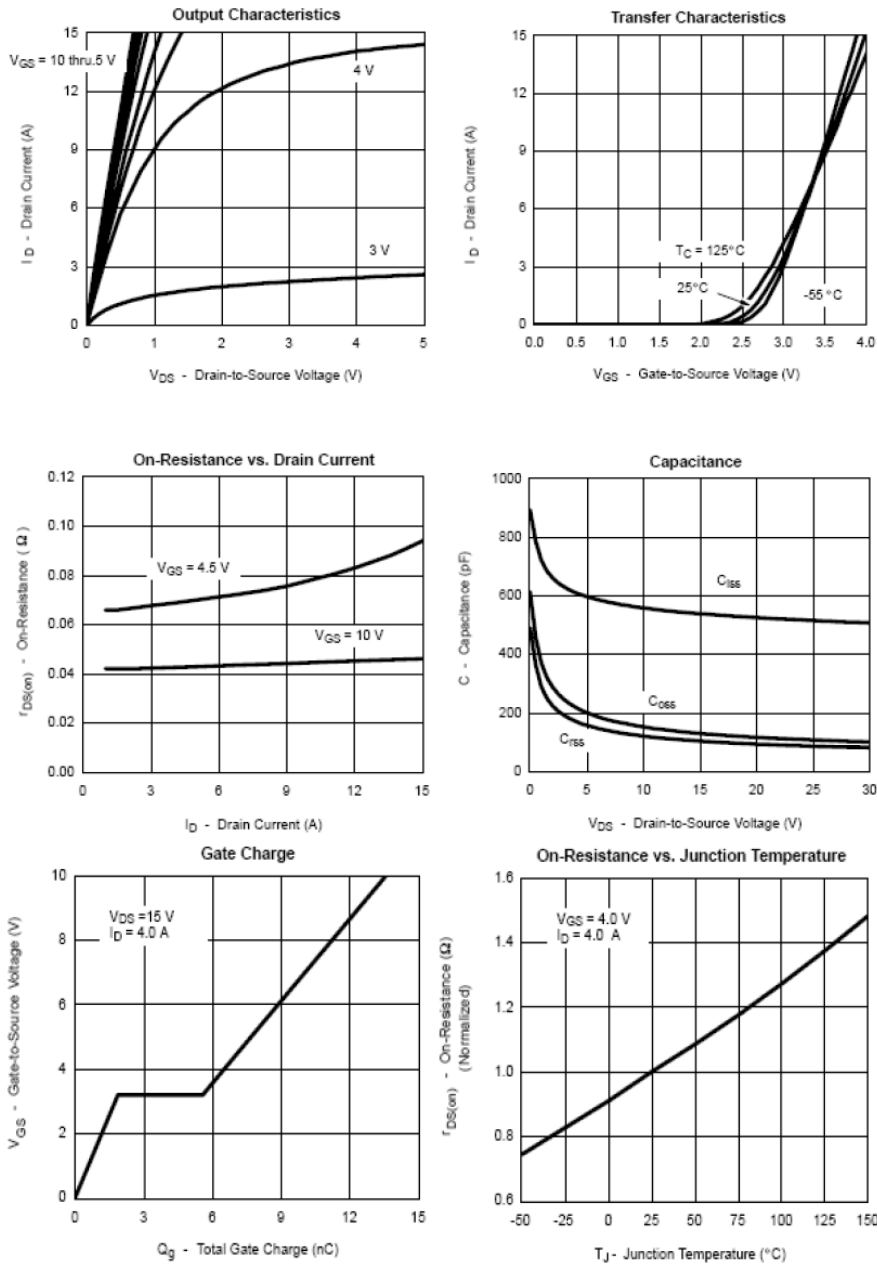

TYPICAL CHARACTERISTICS (25°C Unless noted)

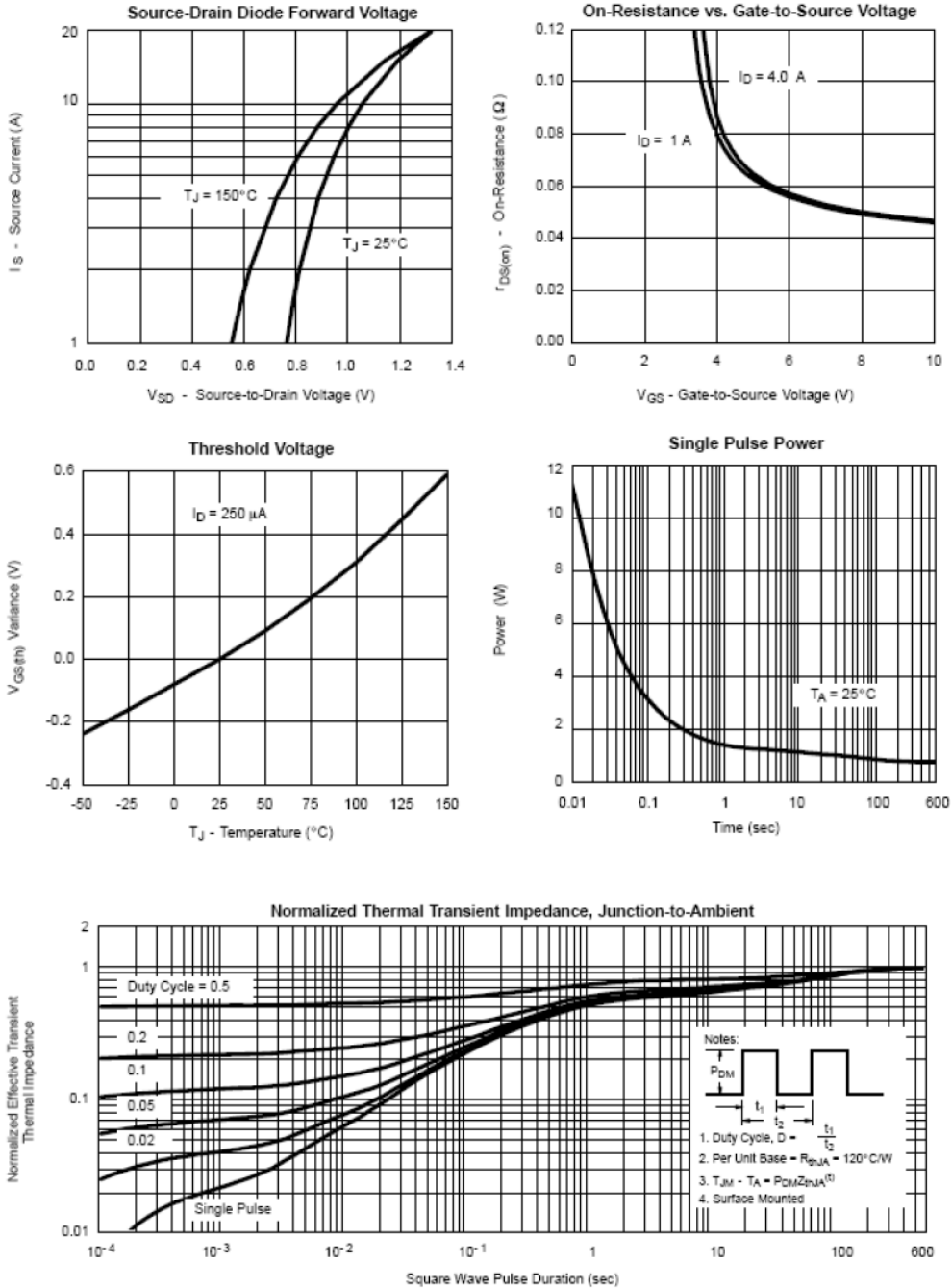

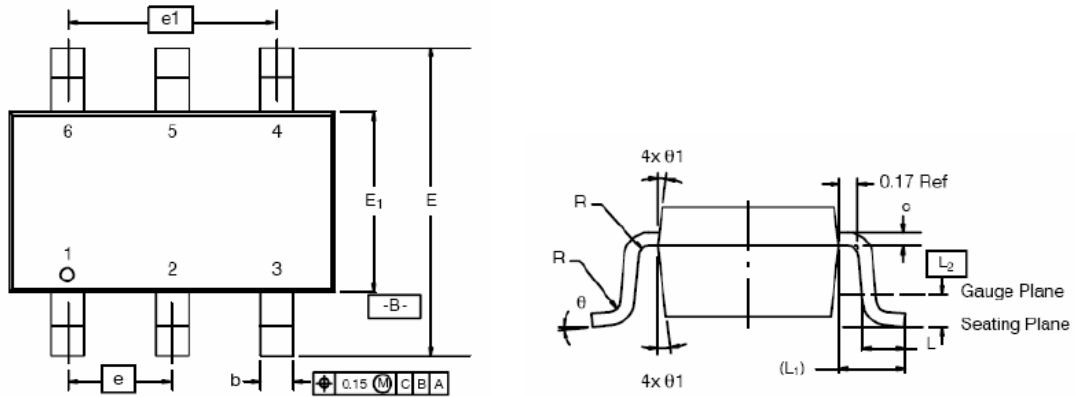
TSOP-6P PACKAGE OUTLINE

Dim	MILLIMETERS			INCHES		
	Min	Nom	Max	Min	Nom	Max
A	0.91	-	1.10	0.036	-	0.043
A ₁	0.01	-	0.10	0.0004	-	0.004
A ₂	0.90	-	1.00	0.035	0.038	0.039
b	0.30	0.32	0.45	0.012	0.013	0.018
c	0.10	0.15	0.20	0.004	0.006	0.008
D	2.95	3.05	3.10	0.116	0.120	0.122
E	2.70	2.85	2.98	0.106	0.112	0.117
E ₁	1.55	1.65	1.70	0.061	0.065	0.067
e	1.00 BSC			0.0394 BSC		
e ₁	1.90	2.00	2.10	0.075	0.080	0.085
L	0.35	-	0.50	0.014	-	0.020
L ₁	0.60 Ref			0.024 Ref		
L ₂	0.25 BSC			0.010 BSC		
R	0.10	-	-	0.004	-	-
θ	0°	4°	8°	0°	4°	8°
θ_1	7° Nom			7° Nom		

www.s-manuals.com