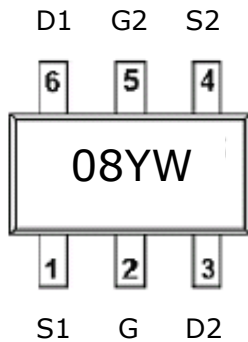
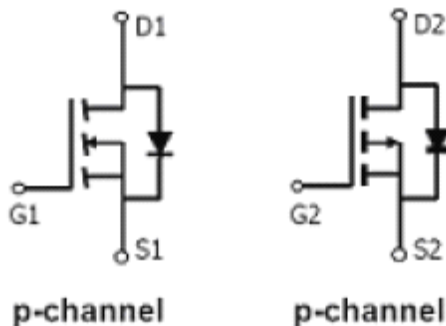

DESCRIPTION

STP6308 is the dual P-Channel enhancement mode power field effect transistor which is produced using high cell density, DMOS trench technology. This high density process is especially tailored to minimize on-state resistance and provide superior switching performance. These devices are particularly suited for low voltage applications such as notebook computer circuits where high-side switching, low in-line power loss and resistance to transients are needed.

**PIN CONFIGURATION
SOT-363 / SC70-6L**

Y: Year
A: Process Code

FEATURE

- -20V/1.0A, $R_{DS(ON)} = 520m\Omega @ V_{GS} = 4.5V$
- -20V/0.8A, $R_{DS(ON)} = 700m\Omega @ V_{GS} = 2.5V$
- -20V/0.7A, $R_{DS(ON)} = 950m\Omega @ V_{GS} = 1.8V$
- Super high density cell design for extremely low $R_{DS(ON)}$
- Exceptional low on-resistance and maximum DC current capability
- SOT-363 / SC70-6L package design

ORDERING INFORMATION

Part Number	Package	Part Marking
STP6308	SOT-363 / SC70-6L	YA

※ Process Code : A ~ Z(1~26) ; a ~ z(27~52)

STANSON TECHNOLOGY
 120 Bentley Square, Mountain View, Ca 94040 USA
<http://www.stansontech.com>



ABSOLUTE MAXIMUM RATINGS (Ta = 25°C Unless otherwise noted)

Parameter		Symbol	Typical	Unit
Drain-Source Voltage		V _{DSS}	-20	V
Gate-Source Voltage		V _{GSS}	±20	V
Continuous Drain Current (T _J =150°C)	T _A =25°C	I _D	-1.0	A
	T _A =80°C		-0.7	
Pulsed Drain Current		I _{DM}	-3	A
Continuous Source Current (Diode Conduction)		I _S	-0.6	A
Power Dissipation	T _A =25°C	P _D	0.35	W
	T _A =70°C		0.19	
Operation Junction Temperature		T _J	-55/150	°C
Storage Temperature Range		T _{STG}	-55/150	°C
Thermal Resistance-Junction to Ambient	T ≤ 10sec	R _{θJA}	360	°C/W
	Steady State		400	

ELECTRICAL CHARACTERISTICS (Ta = 25°C Unless otherwise noted)

Parameter	Symbol	Condition	Min	Typ	Max	Unit
OFF CHARACTERISTICS						
Drain-Source Breakdown Voltage	$V_{(BR)DSS}$	$V_{GS}=0V, I_D=250\mu A$	-20			V
Gate Threshold Voltage	$V_{GS(th)}$	$V_{DS}=V_{GS}, I_D=250\mu A$	-0.35		-0.8	V
Gate Leakage Current	I_{GSS}	$V_{DS}=0V, V_{GS}=+/-12V$			± 100	nA
Zero Gate Voltage Drain Current	I_{DSS}	$V_{DS}=20V, V_{GS}=0V$			-1	uA
		$V_{DS}=20V, V_{GS}=0V$ $T_J=85^\circ C$			-5	
On-State Drain Current	$I_{D(on)}$	$V_{DS} \leq 5V, V_{GS}=4.5V$	-2			A
Drain-source On-Resistance	$R_{DS(on)}$	$V_{GS}=4.5V, I_D=1.0A$		420	520	mΩ
		$V_{GS}=2.5V, I_D=0.8A$		580	700	
		$V_{GS}=1.8V, I_D=0.5A$		750	950	
Forward Transconductance	g_{fs}	$V_{DS}=10V, I_D=1.0A$		1.5		S
Diode Forward Voltage	V_{SD}	$I_S=0.5A, V_{GS}=0V$		-0.8	-1.2	V
DYNAMIC						
Total Gate Charge	Q_g	$V_{DS}=-10V, V_{GS}=-4.5V,$ $I_D=0.88A$		1.5	2.0	nC
Gate-Source Charge	Q_{gs}			0.3		
Gate-Drain Charge	Q_{gd}			0.2		
Input Capacitance	C_{iss}	$V_{DS}=-10V, V_{GS}=0V$ $f=1MHz$		145		pF
Output Capacitance	C_{oss}			25		
Reverse Transfer Capacitance	C_{rss}			10		
Turn-On Time	$T_{d(on)}$	$V_{DD}=10V, R_L=20\Omega, I_D=-0.5A,$ $V_{GEN}=-4.5V, R_G=6\Omega$		18	30	nS
	t_r			25	40	
Turn-Off Time	$T_{d(off)}$			15	45	
	t_f			12	20	

TYPICAL CHARACTERISTICS

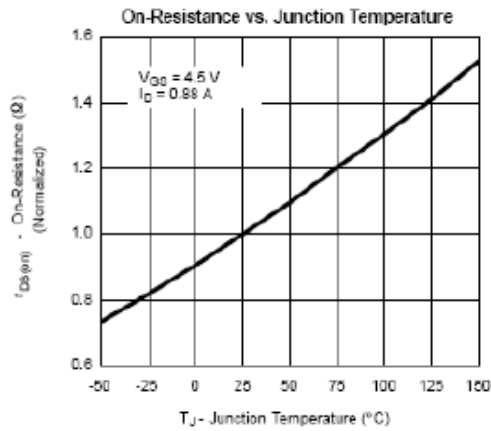
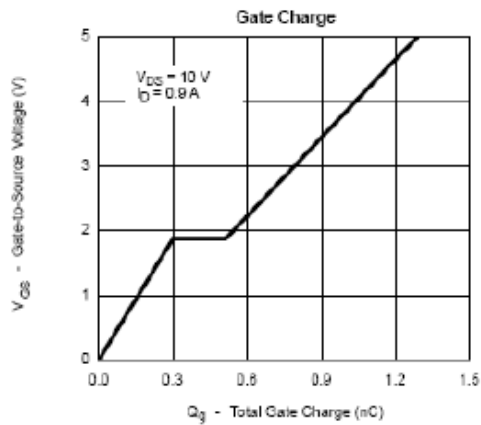
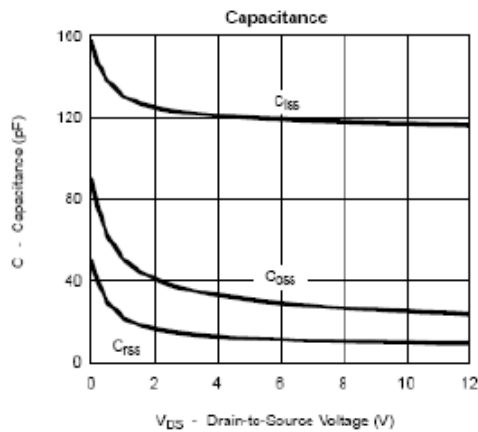
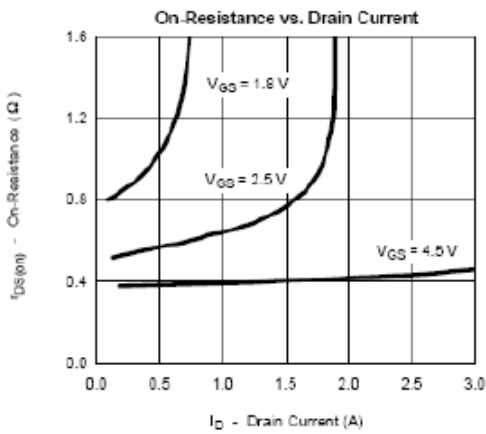
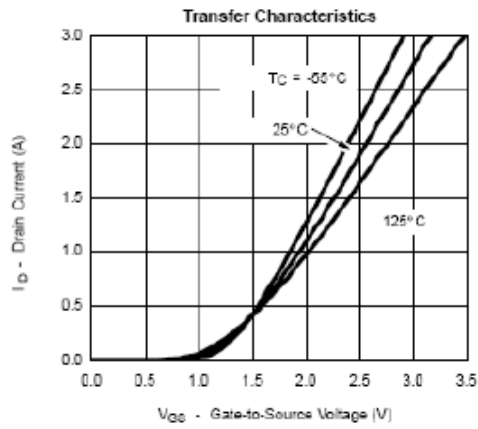
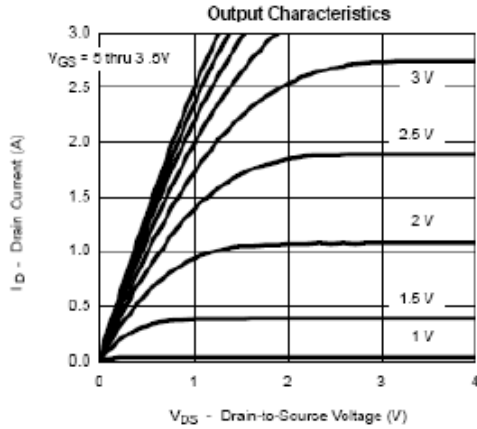

TYPICAL CHARACTERISTICS

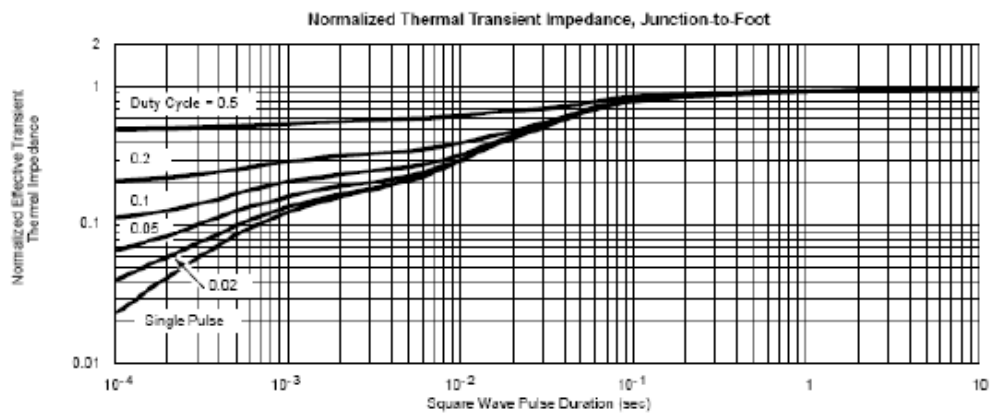
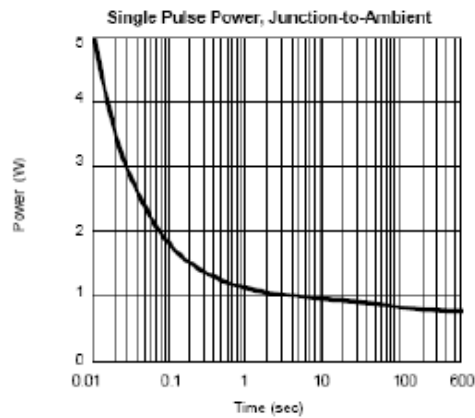
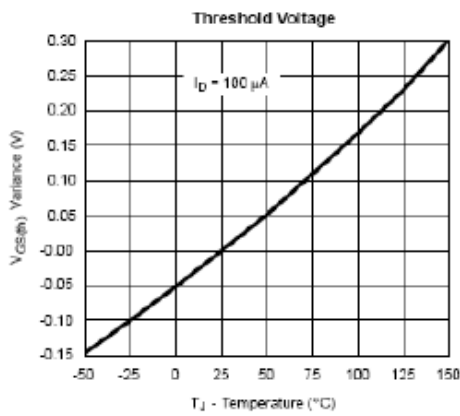
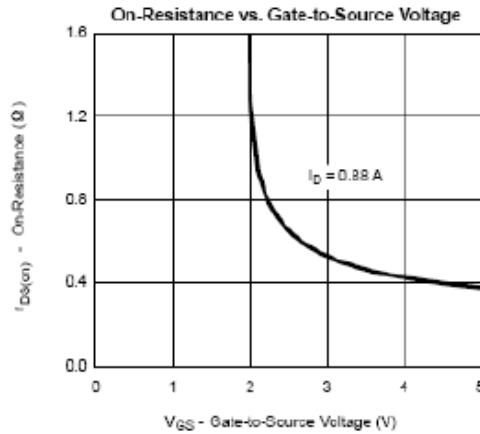
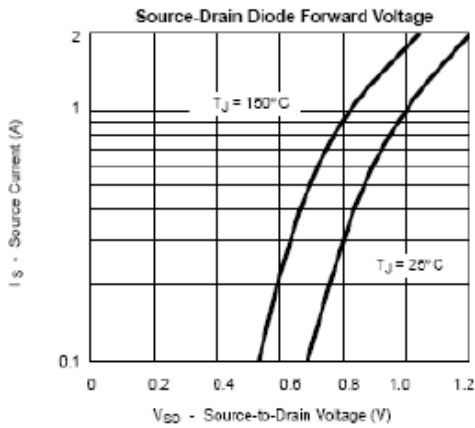

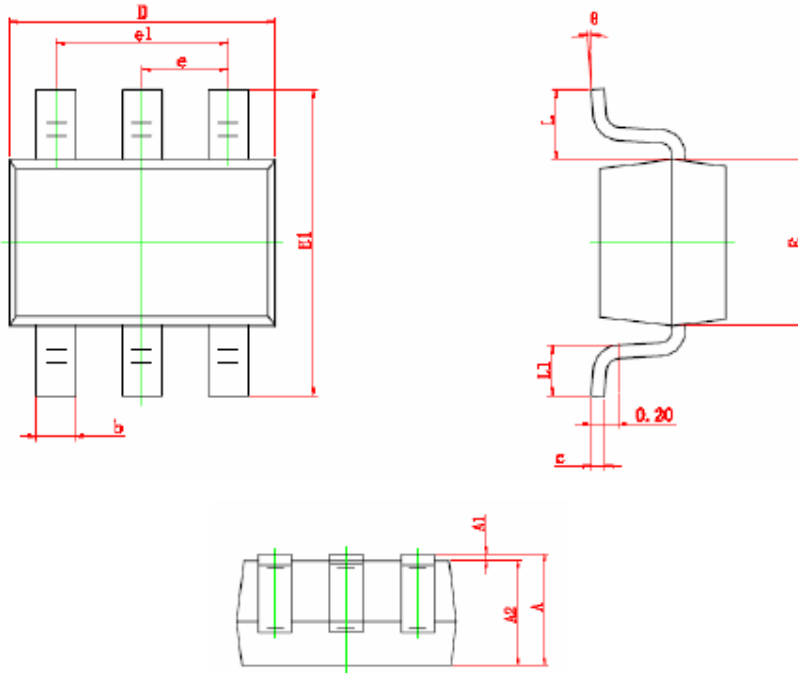
SOT363 (sc70-6L) PACKAGE OUTLINE

Symbol	Dimensions In Millimeters		Dimensions In Inches	
	Min	Max	Min	Max
A	0.900	1.100	0.035	0.043
A1	0.000	0.100	0.000	0.004
A2	0.900	1.000	0.035	0.039
b	0.150	0.350	0.006	0.014
c	0.080	0.150	0.003	0.006
D	2.000	2.200	0.079	0.087
E	1.150	1.350	0.045	0.053
E1	2.150	2.450	0.085	0.096
e	0.650 TYP		0.026 TYP	
e1	1.200	1.400	0.047	0.055
L	0.525 REF		0.021 REF	
L1	0.260	0.460	0.010	0.018
theta	0°	8°	0°	8°

www.s-manuals.com