

4V Drive Pch+SBD MOSFET

US5U35

●Structure

Silicon P-channel MOSFET
Schottky Barrier DIODE

●Features

- 1) The US5U35 combines Pch MOSFET with a Schottky barrier diode in a TUMT5 package.
- 2) With fast switching.
- 3) Built-in schottky barrier diode has low forward voltage.

●Applications

Switching

●Packaging specifications

Type	Package	Taping
	Code	TR
	Basic ordering unit (pieces)	3000
US5U35		○

●Dimensions (Unit : mm)

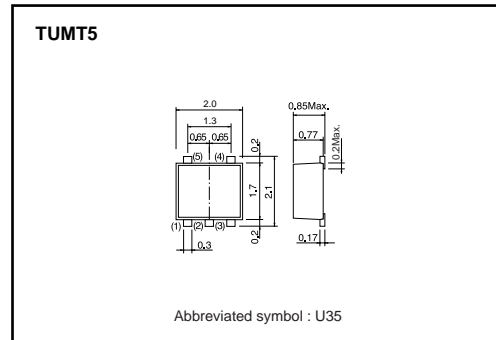

●Equivalent circuit

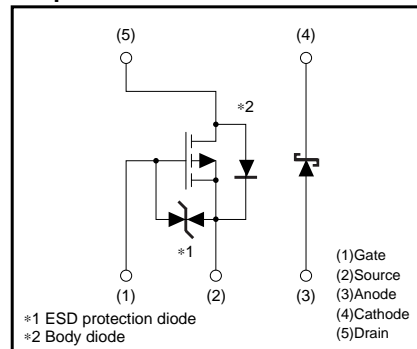

Transistor

●Absolute maximum ratings (Ta=25°C)

<MOSFET>

Parameter	Symbol	Limits	Unit
Drain-source voltage	V _{DSS}	-45	V
Gate-source voltage	V _{GSS}	±20	V
Drain current	Continuous	I _D	±0.7
	Pulsed	I _{DP} *1	±2.8
Source current (Body diode)	Continuous	I _S	-0.4
	Pulsed	I _{SP} *1	-2.8
Channel temperature	T _{ch}	150	°C
Power dissipation	P _D *3	0.7	W / ELEMENT

<Di>

Repetitive peak reverse voltage	V _{RM}	45	V
Reverse voltage	V _R	40	V
Forward current	I _F	100	mA
Forward current surge peak	I _{FSM} *2	1.0	A
Junction temperature	T _j	150	°C
Power dissipation	P _D *3	0.5	W / ELEMENT

<MOSFET AND Di>

Power dissipation	P _D *3	1.0	W / TOTAL
Range of storage temperature	T _{stg}	-55 to +150	°C

*1 Pw≤10μs, Duty cycles≤1% *2 60Hz-1cyc. *3 Mounted on a ceramic board

●Electrical characteristics (Ta=25°C)

<MOSFET>

Parameter	Symbol	Min.	Typ.	Max.	Unit	Conditions
Gate-source leakage	I _{gss}	-	-	±10	μA	V _{GS} =±20V, V _{DS} =0V
Drain-source breakdown voltage	V _{(BR) DSS}	-45	-	-	V	I _D =-1mA, V _{GS} =0V
Zero gate voltage drain current	I _{DSS}	-	-	-1	μA	V _{DS} =-45V, V _{GS} =0V
Gate threshold voltage	V _{GS(th)}	-1.0	-	-2.5	V	V _{DS} =-10V, I _D =-1mA
Static drain-source on-state resistance	R _{DS(on)} *	-	0.6	0.8	Ω	I _D =-0.7A, V _{GS} =-10V
		-	0.9	1.3	Ω	I _D =-0.7A, V _{GS} =-4.5V
		-	1.0	1.4	Ω	I _D =-0.35A, V _{GS} =-4.0V
Forward transfer admittance	Y _{fs} *	0.6	-	-	S	V _{DS} =-10V, I _D =-0.7A
Input capacitance	C _{iss}	-	120	-	pF	V _{DS} =-10V
Output capacitance	C _{oss}	-	14	-	pF	V _{GS} =0V
Reverse transfer capacitance	C _{rss}	-	11	-	pF	f=1MHz
Turn-on delay time	t _{d(on)} *	-	6	-	ns	I _D =-0.35A
Rise time	t _r *	-	5	-	ns	V _{DD} ≐-25V V _{GS} =-10V
Turn-off delay time	t _{d(off)} *	-	17	-	ns	R _L ≐71Ω
Fall time	t _f *	-	6	-	ns	R _G =10Ω
Total gate charge	Q _g	-	1.7	-	nC	V _{DD} ≐-25V, V _{GS} =-5V
Gate-source charge	Q _{gs}	-	0.8	-	nC	I _D =-0.7A
Gate-drain charge	Q _{gd}	-	0.5	-	nC	R _L ≐36Ω, R _G =10Ω

* Pulsed

<Body diode (source-drain)>

Parameter	Symbol	Min.	Typ.	Max.	Unit	Conditions
Forward voltage	V _{SD} *	-	-	-1.2	V	I _S =-0.7A, V _{GS} =0V

* Pulsed

<Di>

Parameter	Symbol	Min.	Typ.	Max.	Unit	Conditions
Forward voltage	V _F	-	-	0.55	V	I _F =100mA
Reverse current	I _R	-	-	30	μA	V _R =10V

Transistor

●Electrical characteristic curves

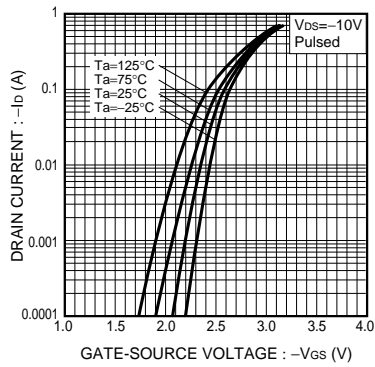

Fig.1 Typical Transfer Characteristics

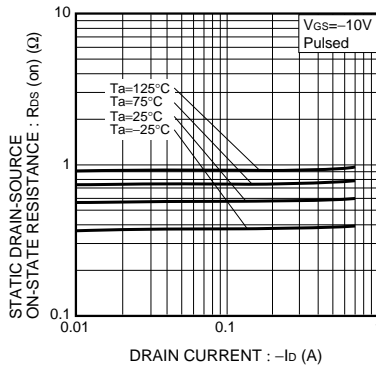

Fig.2 Static Drain-Source On-State Resistance vs. Drain Current(I)

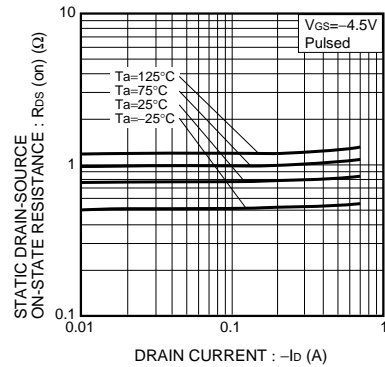

Fig.3 Static Drain-Source On-State Resistance vs. Drain Current(II)

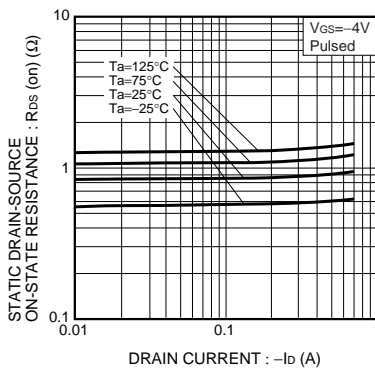

Fig.4 Static Drain-Source On-State Resistance vs. Drain Current(III)

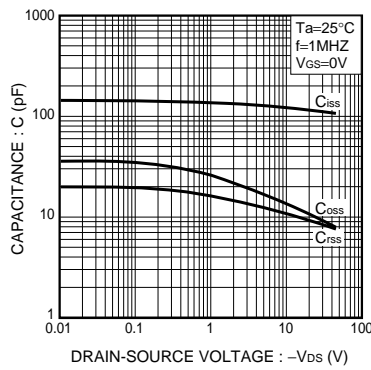

Fig.5 Typical Capacitance vs. Drain-Source Voltage

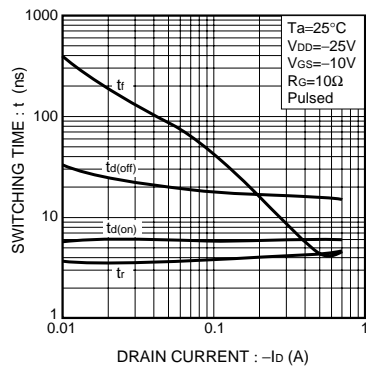

Fig.6 Switching Characteristics

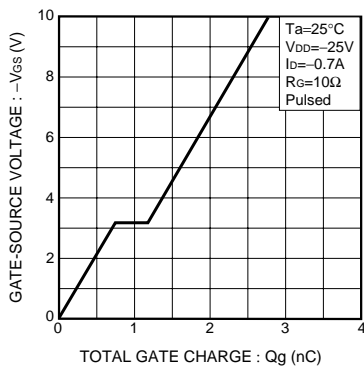

Fig.7 Dynamic Input Characteristics

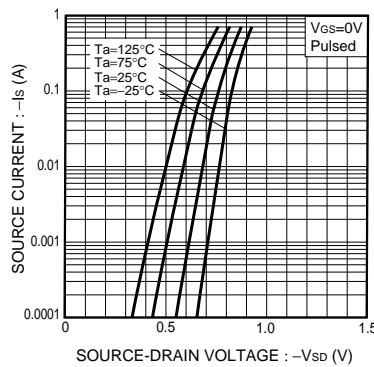

Fig.8 Source Current vs. Source-Drain Voltage

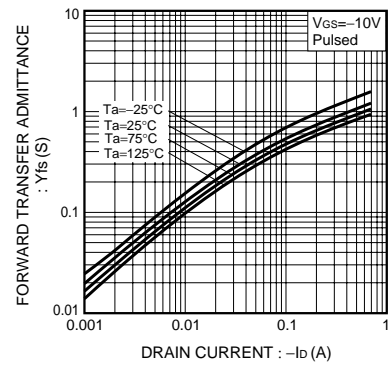

Fig.9 Forward Transfer Admittance vs. Drain Current

Transistor

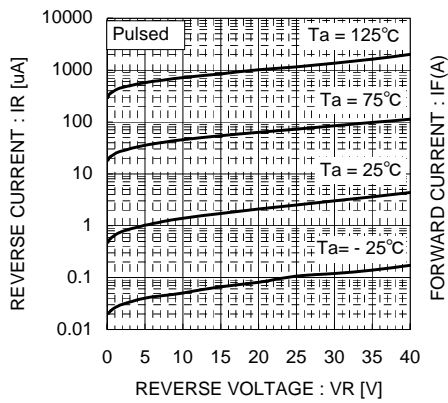

Fig.10 Reverse Current vs. Reverse Voltage

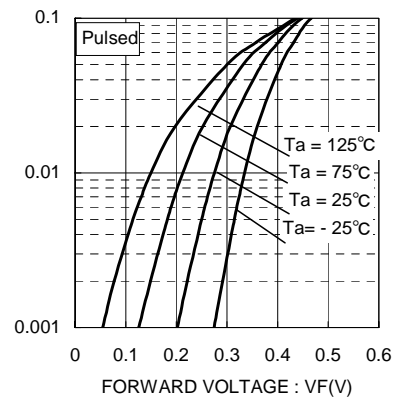

Fig.11 Forward Current vs. Forward Voltage

●Notice

1. SBD has a large reverse leak current compared to other type of diode. Therefore; it would raise a junction temperature, and increase a reverse power loss. Further rise of inside temperature would cause a thermal runaway.
This built-in SBD has low V_F characteristics and therefore, higher leak current. Please consider enough the surrounding temperature, generating heat of MOSFET and the reverse current.
2. This product might cause chip aging and breakdown under the large electrified environment.
Please consider to design ESD protection circuit.

Transistor

● Measurement circuits

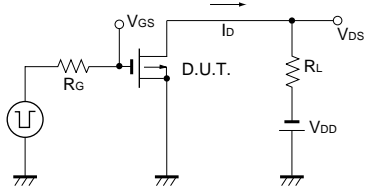

Fig.12 Switching Time Measurement Circuit

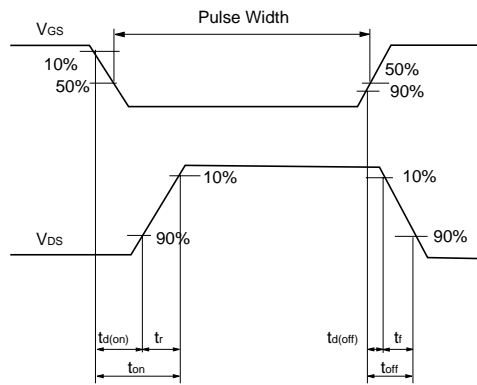

Fig.13 Switching Waveforms

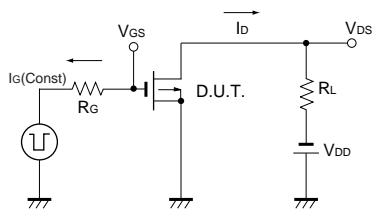

Fig.14 Gate Charge Measurement Circuit

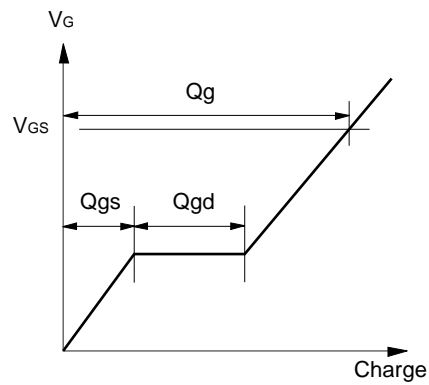

Fig.15 Gate Charge Waveforms

Notes

- No technical content pages of this document may be reproduced in any form or transmitted by any means without prior permission of ROHM CO.,LTD.
- The contents described herein are subject to change without notice. The specifications for the product described in this document are for reference only. Upon actual use, therefore, please request that specifications to be separately delivered.
- Application circuit diagrams and circuit constants contained herein are shown as examples of standard use and operation. Please pay careful attention to the peripheral conditions when designing circuits and deciding upon circuit constants in the set.
- Any data, including, but not limited to application circuit diagrams information, described herein are intended only as illustrations of such devices and not as the specifications for such devices. ROHM CO.,LTD. disclaims any warranty that any use of such devices shall be free from infringement of any third party's intellectual property rights or other proprietary rights, and further, assumes no liability of whatsoever nature in the event of any such infringement, or arising from or connected with or related to the use of such devices.
- Upon the sale of any such devices, other than for buyer's right to use such devices itself, resell or otherwise dispose of the same, no express or implied right or license to practice or commercially exploit any intellectual property rights or other proprietary rights owned or controlled by
- ROHM CO., LTD. is granted to any such buyer.
- Products listed in this document are no antiradiation design.

The products listed in this document are designed to be used with ordinary electronic equipment or devices (such as audio visual equipment, office-automation equipment, communications devices, electrical appliances and electronic toys).

Should you intend to use these products with equipment or devices which require an extremely high level of reliability and the malfunction of which would directly endanger human life (such as medical instruments, transportation equipment, aerospace machinery, nuclear-reactor controllers, fuel controllers and other safety devices), please be sure to consult with our sales representative in advance.

It is our top priority to supply products with the utmost quality and reliability. However, there is always a chance of failure due to unexpected factors. Therefore, please take into account the derating characteristics and allow for sufficient safety features, such as extra margin, anti-flammability, and fail-safe measures when designing in order to prevent possible accidents that may result in bodily harm or fire caused by component failure. ROHM cannot be held responsible for any damages arising from the use of the products under conditions out of the range of the specifications or due to non-compliance with the NOTES specified in this catalog.

Thank you for your accessing to ROHM product informations.

More detail product informations and catalogs are available, please contact your nearest sales office.

ROHM Customer Support System

THE AMERICAS / EUROPE / ASIA / JAPAN

www.rohm.com

Contact us : webmaster@rohm.co.jp

www.s-manuals.com