



UT6401

Power MOSFET

5A, 30V P-CHANNEL ENHANCEMENT MODE

■ DESCRIPTION

The UTC **UT6401** is P-channel enhancement mode Power MOSFET, designed with high density cell, with fast switching speed, low on-resistance, excellent thermal and electrical capabilities, operation with low gate charge.

This device is suitable for use as a load switch or in PWM applications.

■ SYMBOL

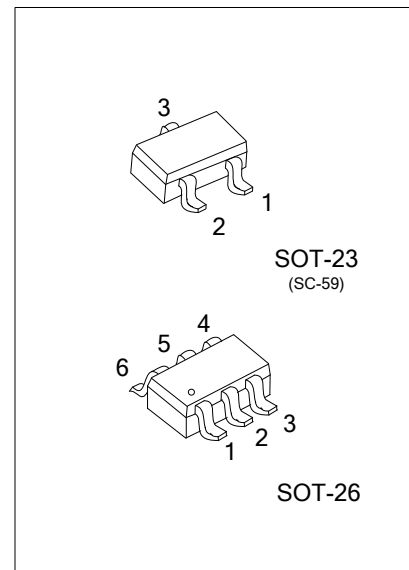
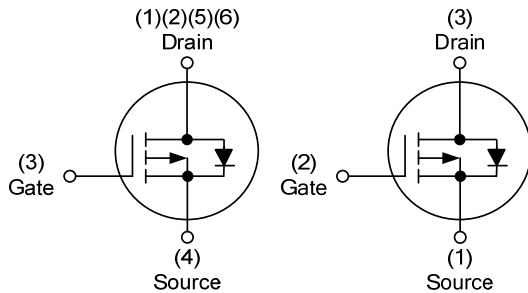

■ ORDERING INFORMATION

Ordering Number	Package	Pin Assignment						Packing
		1	2	3	4	5	6	
UT6401G-AE3-R	SOT-23	S	G	D	-	-	-	Tape Reel
UT6401G-AG6-R	SOT-26	D	D	G	S	D	D	Tape Reel

Note: Pin Assignment: G: Gate D: Drain S: Source

<p>UT6401G-AG6-R</p> <ul style="list-style-type: none"> (1) Packing Type (2) Package Type (3) Green Package 	<ul style="list-style-type: none"> (1) R: Tape Reel (2) AG6: SOT-26, AE3: SOT-23 (3) G: Halogen Free and Lead Free
--	---

■ MARKING

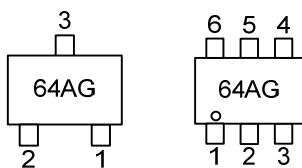

■ ABSOLUTE MAXIMUM RATINGS ($T_A = 25^\circ\text{C}$, unless otherwise specified)

PARAMETER	SYMBOL	RATINGS	UNIT
Drain-Source Voltage	V_{DS}	-30	V
Gate-Source Voltage	V_{GS}	± 12	
Continuous Drain Current (Note 3)	I_D	-5	A
Pulsed Drain Current (Note 2)	I_{DM}	-20	
Power Dissipation	SOT-23	1.38	W
	SOT-26	2	
Junction Temperature	T_J	+150	$^\circ\text{C}$
Storage Temperature	T_{STG}	-55 ~ +150	$^\circ\text{C}$

Note: Absolute maximum ratings are those values beyond which the device could be permanently damaged.

Absolute maximum ratings are stress ratings only and functional device operation is not implied.

■ THERMAL DATA

PARAMETER	SYMBOL	MIN	TYP	MAX	UNIT
Junction to Ambient (Note 3)	SOT-23			90	$^\circ\text{C/W}$
	SOT-26			110	

■ ELECTRICAL CHARACTERISTICS ($T_J = 25^\circ\text{C}$, unless otherwise specified)

PARAMETER	SYMBOL	TEST CONDITIONS	MIN	TYP	MAX	UNITS
OFF CHARACTERISTICS						
Drain-Source Breakdown Voltage	BV_{DS}	$V_{GS}=0\text{V}, I_D=-250\mu\text{A}$	-30			V
Drain-Source Leakage Current	I_{DSS}	$V_{DS}=-24\text{V}, V_{GS}=0\text{V}$			-1	μA
Gate-Source Leakage Current	I_{GSS}	$V_{DS}=0\text{V}, V_{GS}=\pm 12\text{V}$			± 100	nA
ON CHARACTERISTICS						
Gate Threshold Voltage	$V_{GS(TH)}$	$V_{DS}=V_{GS}, I_D=-250\mu\text{A}$	-0.7	-1	-1.3	V
On State Drain Current	$I_{D(ON)}$	$V_{DS}=-5\text{V}, V_{GS}=-4.5\text{V}$	-25			A
Static Drain-Source On-Resistance (Note 2)	$R_{DS(ON)}$	$V_{GS}=-10\text{V}, I_D=-5\text{A}$		42	49	m Ω
		$V_{GS}=-4.5\text{V}, I_D=-4\text{A}$		53	64	m Ω
		$V_{GS}=-2.5\text{V}, I_D=-1\text{A}$		81	119	m Ω
DYNAMIC CHARACTERISTICS						
Input Capacitance	C_{ISS}	$V_{GS}=0\text{V}, V_{DS}=-15\text{V}, f=1.0\text{MHz}$		943		pF
Output Capacitance	C_{OSS}			108		pF
Reverse Transfer Capacitance	C_{RSS}			73		pF
SWITCHING CHARACTERISTICS						
Turn-ON Delay Time (Note 2)	$t_{D(ON)}$	$V_{DS}=-15\text{V}, V_{GS}=-10\text{V}, R_G=6\Omega, R_L=3\Omega$		6		ns
Turn-ON Rise Time	t_R			3		ns
Turn-OFF Delay Time	$t_{D(OFF)}$			40		ns
Turn-OFF Fall Time	t_F			11		ns
Total Gate Charge (Note 2)	Q_G	$V_{DS}=-15\text{V}, V_{GS}=-4.5\text{V}, I_D=-5\text{A}$		9.5		nC
Gate-Source Charge	Q_{GS}			2.1		nC
Gate-Drain Charge	Q_{GD}			2.9		nC
SOURCE-DRAIN DIODE RATINGS AND CHARACTERISTICS						
Drain-Source Diode Forward Voltage(Note2)	V_{SD}	$I_S=-1\text{A}, V_{GS}=0\text{V}$		-0.75	-1	V
Maximum Continuous Drain-Source Diode Forward Current	I_S				-5	A
MAXIMUM Body-Diode Pulsed Current	I_{SM}				-20	A

Notes: 1. Pulse width limited by $T_{J(MAX)}$

2. Pulse width $\leq 300\mu\text{s}$, duty cycle $\leq 0.5\%$.

TYPICAL CHARACTERISTICS

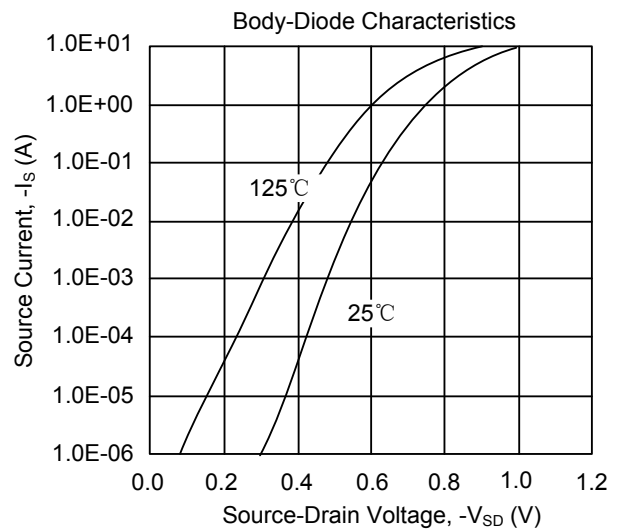
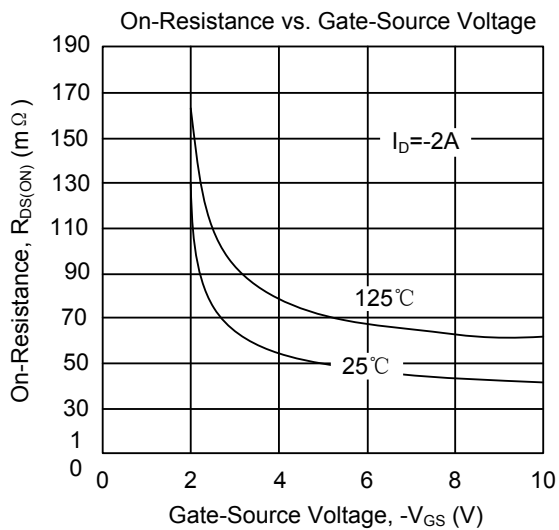
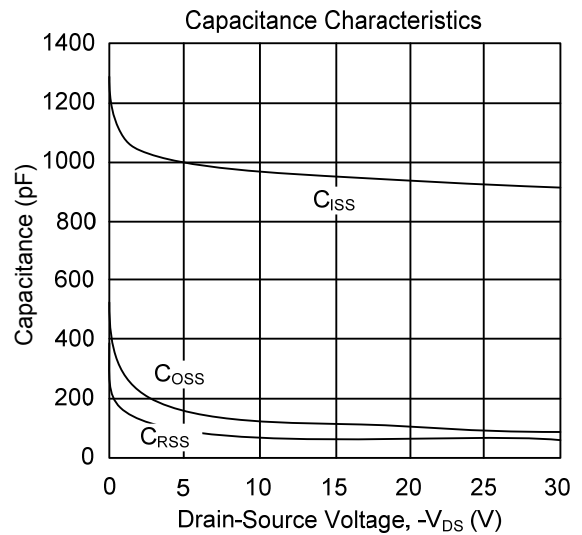
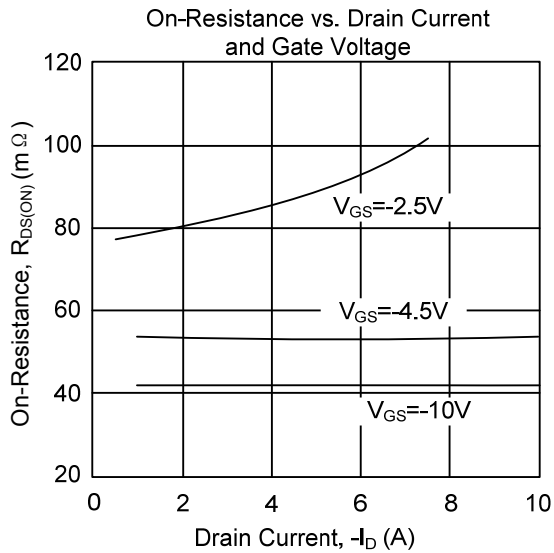
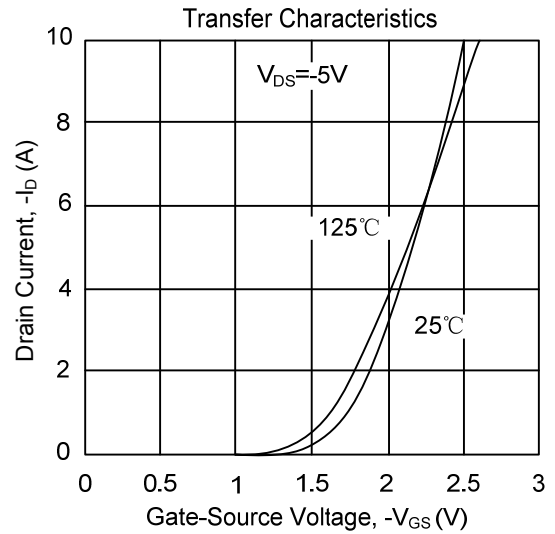
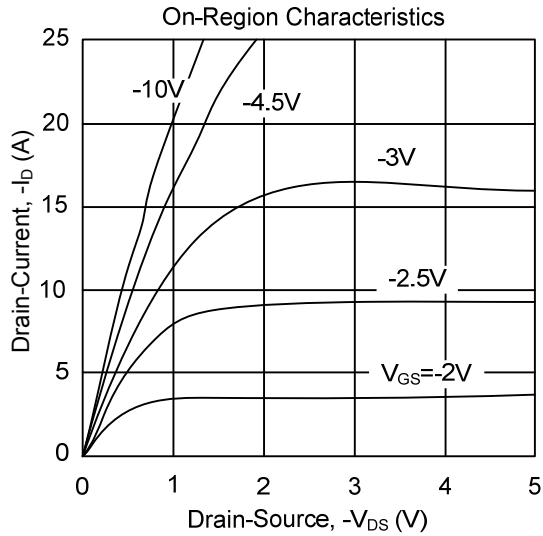

■ TYPICAL CHARACTERISTICS(Cont.)

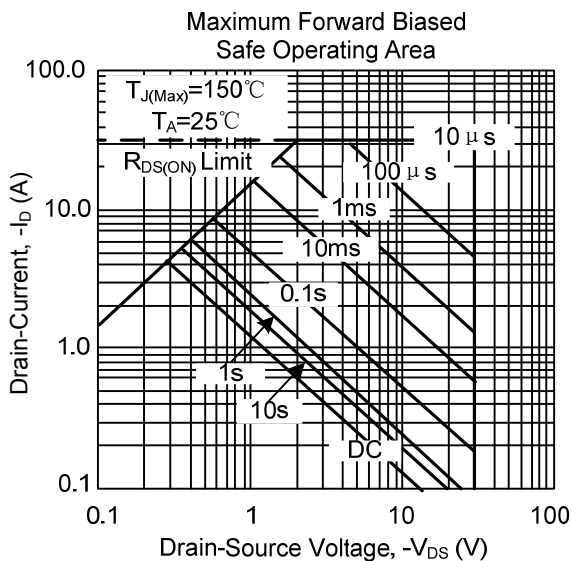
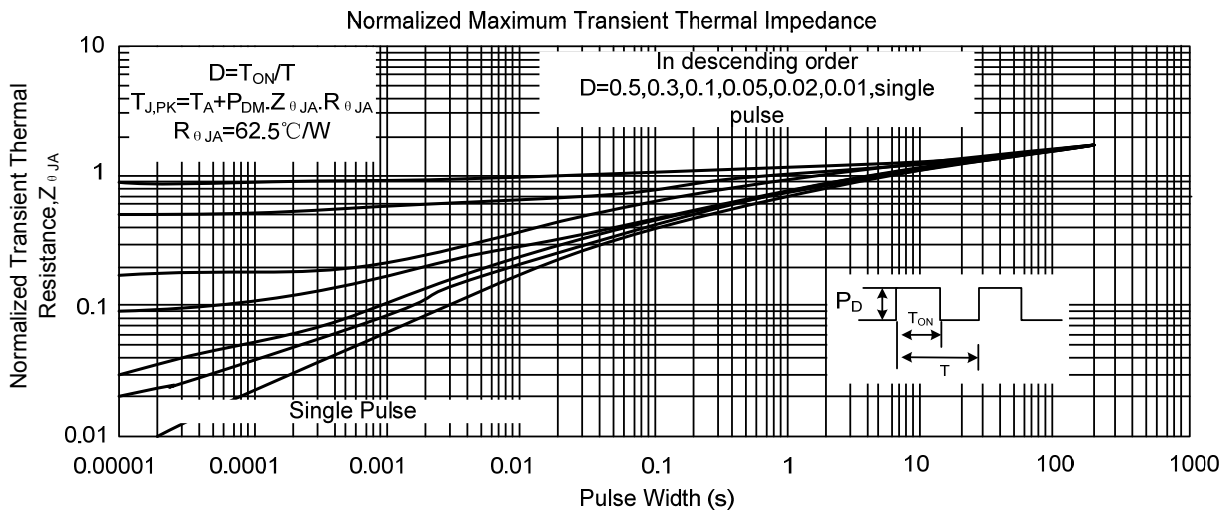
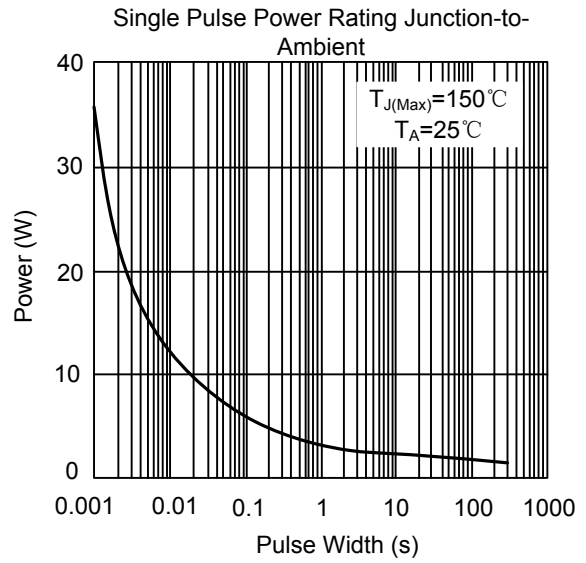
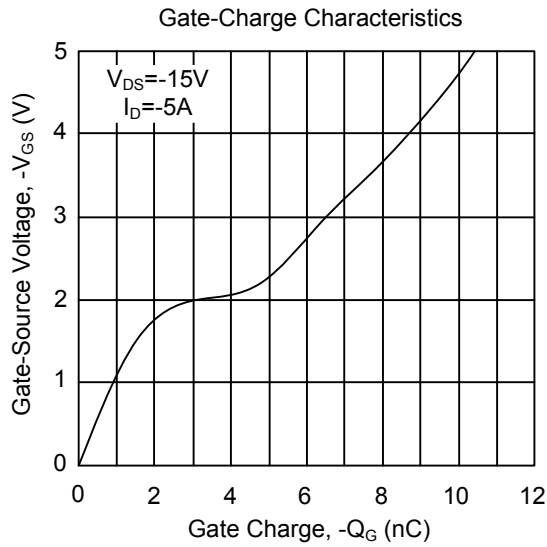

TYPICAL CHARACTERISTICS

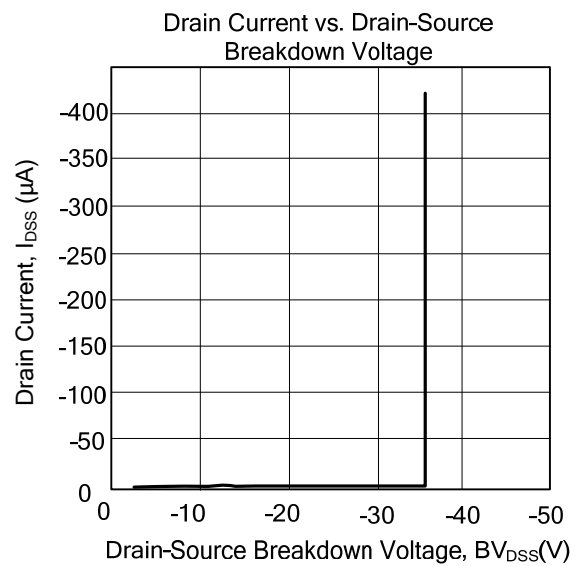
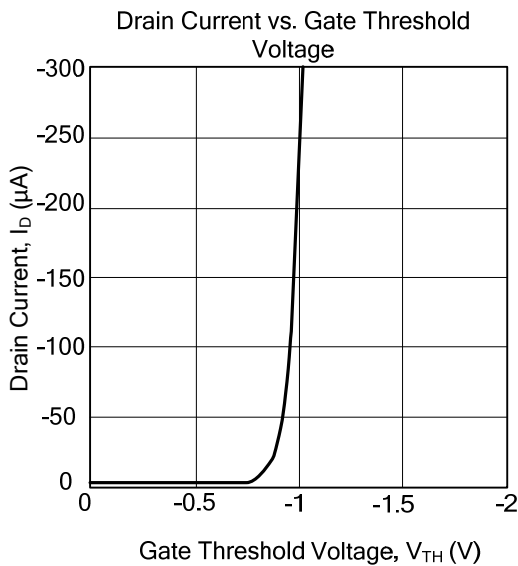
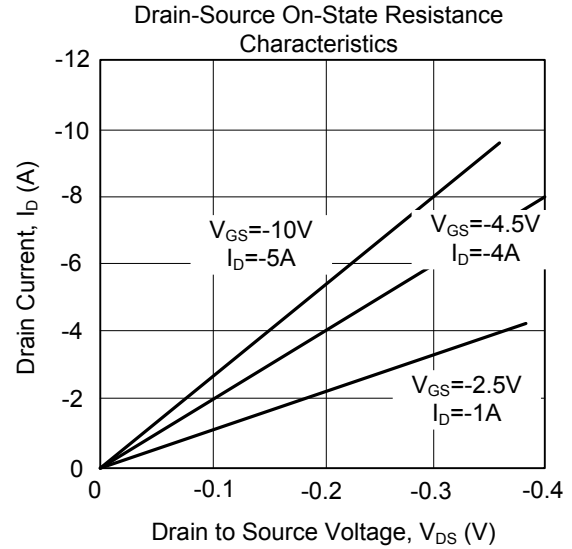
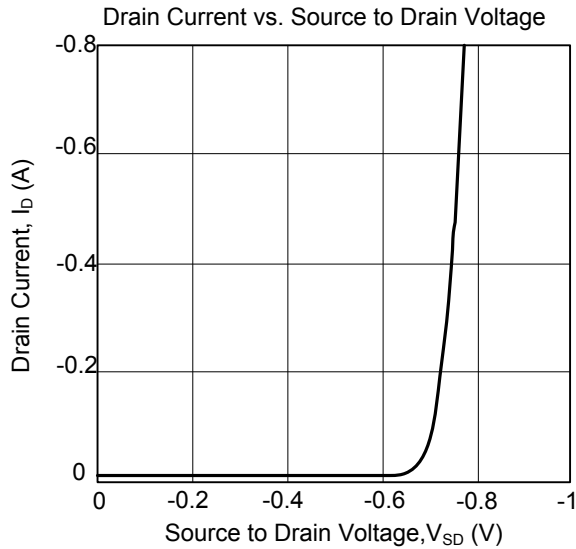

UTC assumes no responsibility for equipment failures that result from using products at values that exceed, even momentarily, rated values (such as maximum ratings, operating condition ranges, or other parameters) listed in products specifications of any and all UTC products described or contained herein. UTC products are not designed for use in life support appliances, devices or systems where malfunction of these products can be reasonably expected to result in personal injury. Reproduction in whole or in part is prohibited without the prior written consent of the copyright owner. The information presented in this document does not form part of any quotation or contract, is believed to be accurate and reliable and may be changed without notice.

www.s-manuals.com